

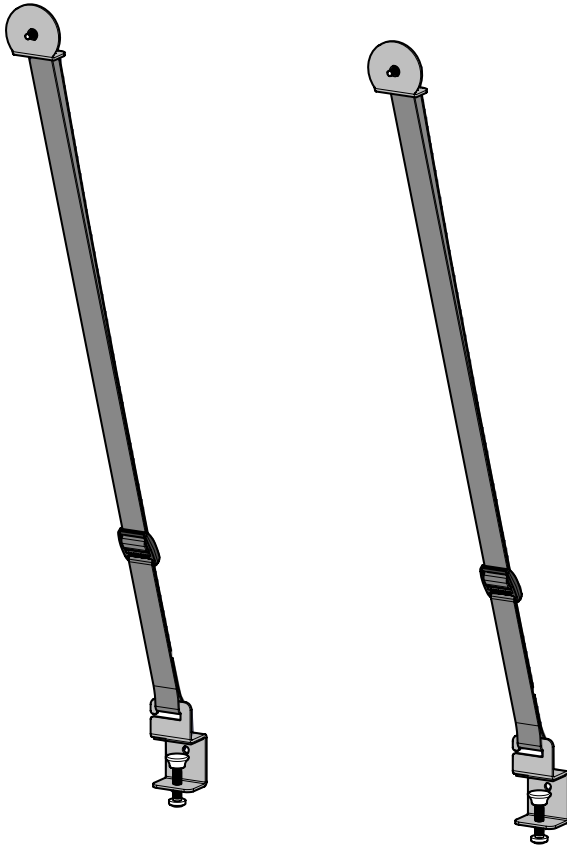

up to 100" / up to 254 cm

Please read these instructions thoroughly before installation.



You will need



Stud Finder

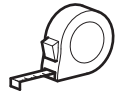
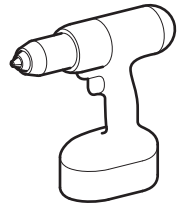

Ø3mm
(1/8")

Wood Stud

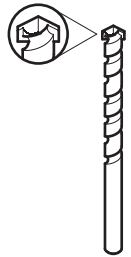

Ø7mm
(17/64")

Solid Wall

Helpline

0333 320 0463 (UK)

1300 762 219 (Australia)

(+64) 9 306 1020 (New Zealand)



Product Information



UK - AVF Group Ltd. Hortonwood 30, Telford, Shropshire, TF1 7YE, England

Australia - Arisit P/L · 40-50 Mark Anthony Drive · Dandenong · South Victoria · 3175

Parts Included

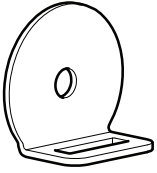

A
x2

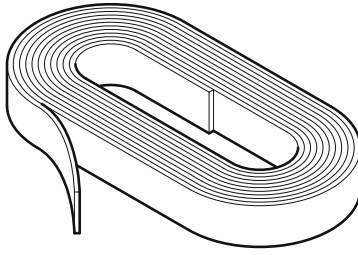

B
x2

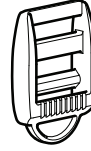

C
x2

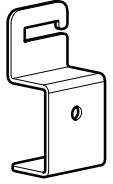

D
x2



E
x2



F
x2

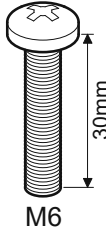

G
x2



K1
x2



K2
x2



L
x1

TV Screws, Reducers and Spacers



H1
x2



H2
x2



I1
x2



I2
x2



You will only need one set of TV Screws



M4

J1
x2

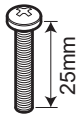

M4

J2
x2

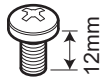

M6

J3
x2

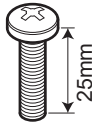

M6

J4
x2

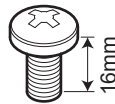

M8

J5
x2

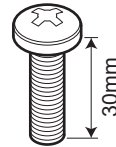

M8

J6
x2

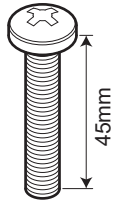

M8

J7
x2

1

Measure your VESA fixings and select TV Screws

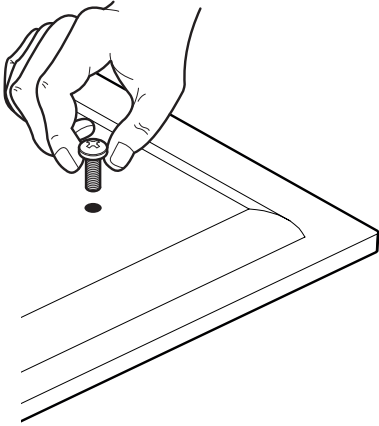

Determine which diameter TV Screws fit your TV and put them to one side.

M4, M6 or M8

We will select the correct length later.

2

Prepare the TV Straps

i

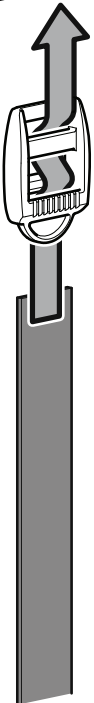

ii

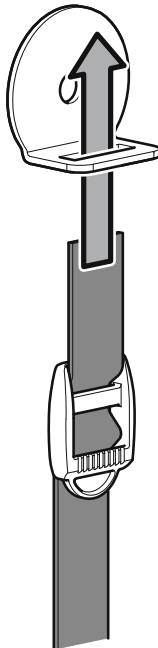

iii

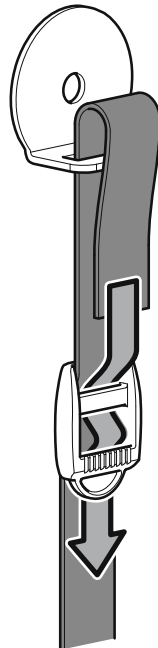

iv

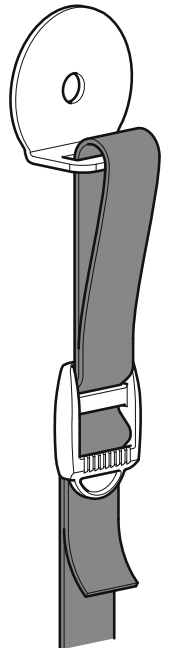

3 Attach the TV Straps

i After completing this step, you will have lots of TV screws left over. Keep them in a safe place in case you require them in future.

You may need to use Spacers **I1** or **I2** if the screws are too long or the back of your TV is not flat.

If required

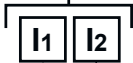

Do you need H1 or H2?

J1 - J2	✓	✓
J3 - J4	✓	✗
J5 - J7	✗	✗
	H1	H2

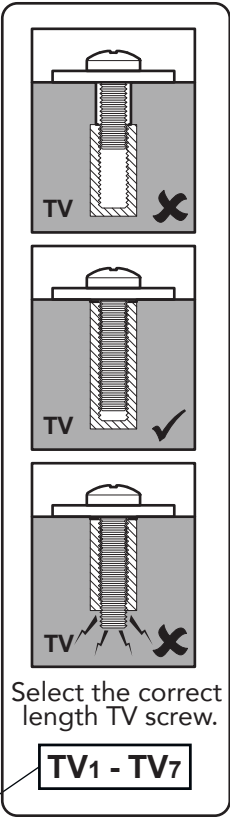

Select the correct length TV screw.

TV1 - TV7

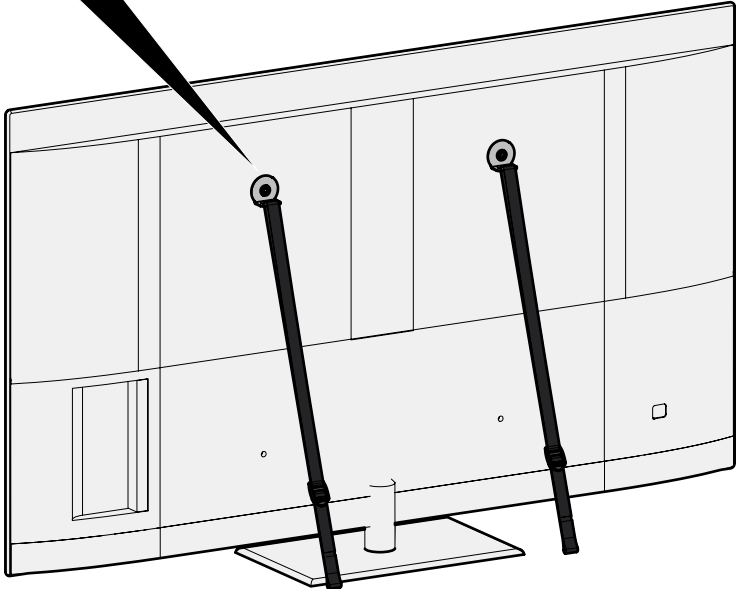
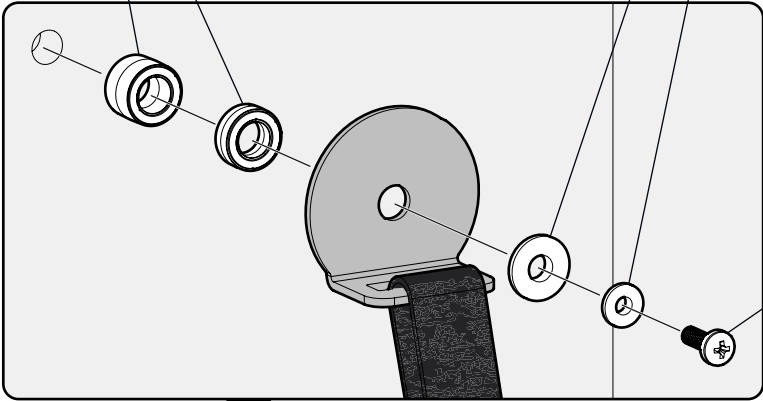

Securing to Furniture or Wall

You can secure your TV to furniture or to the wall, decide how you will secure your TV and follow the appropriate steps.

Securing to Furniture - Follow step 4

You can secure your TV to your furniture in 2 ways

Clamp Method

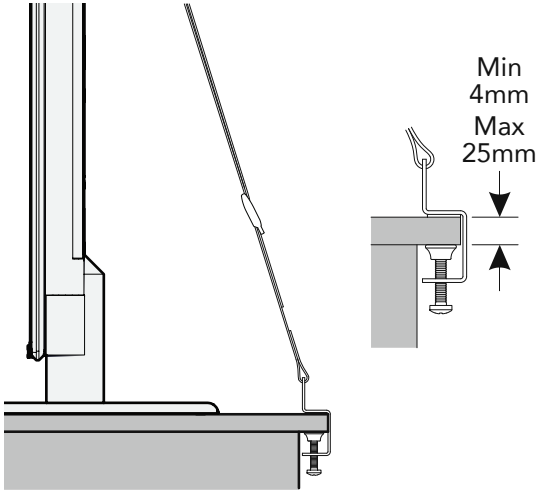

Screw Method

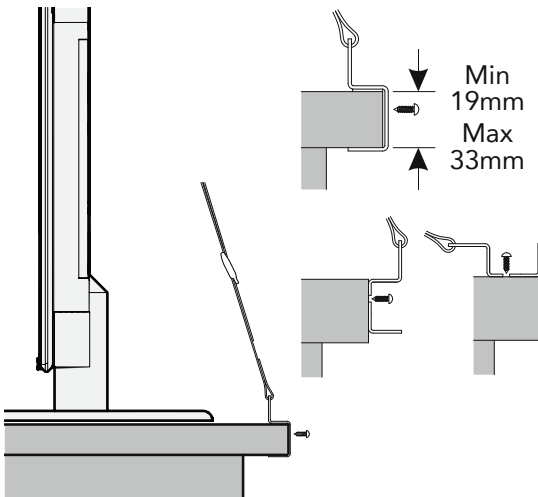

Securing to Wall - Follow step 5

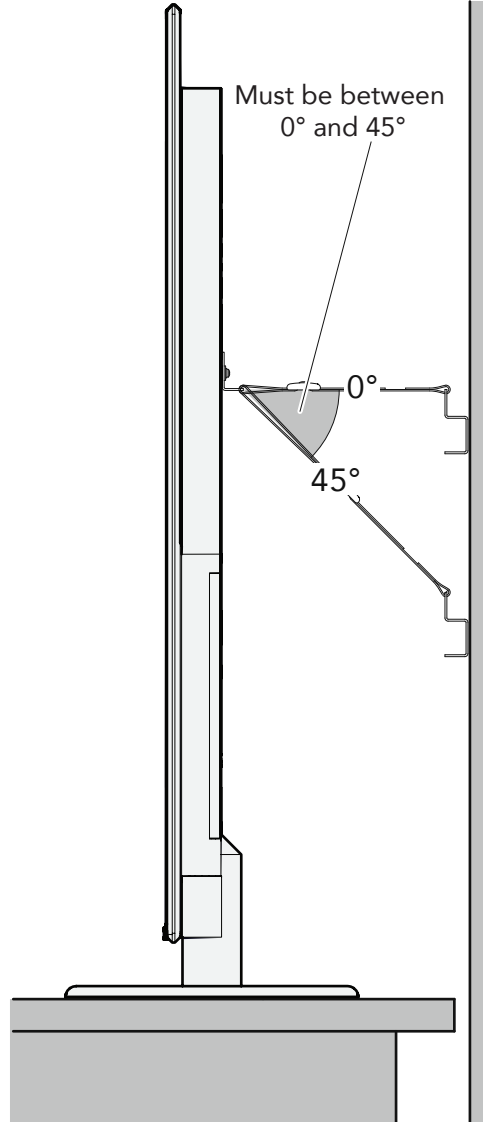

4 Securing to Furniture

Clamp Method

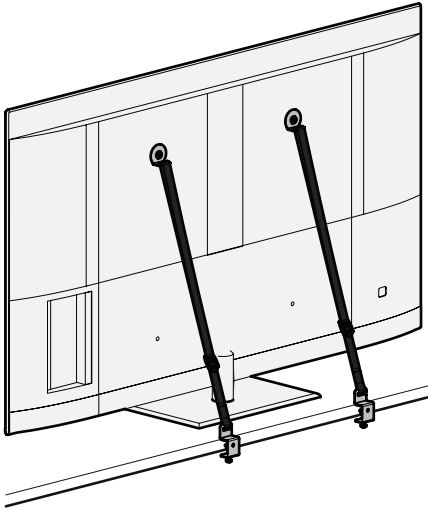

i

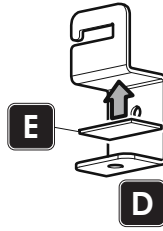

ii

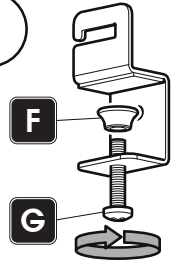

iii

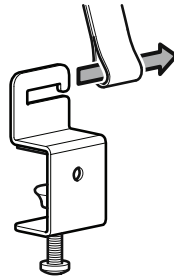

iv

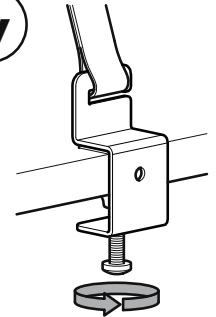

Screw Method

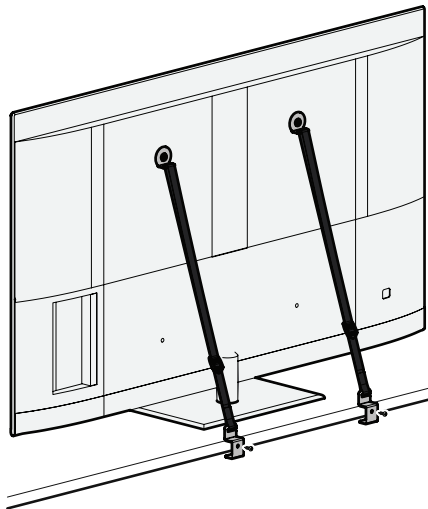

i

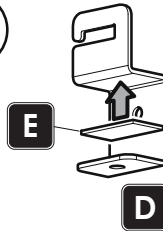

ii

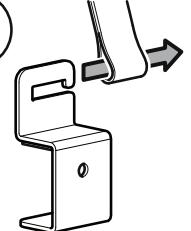

iii

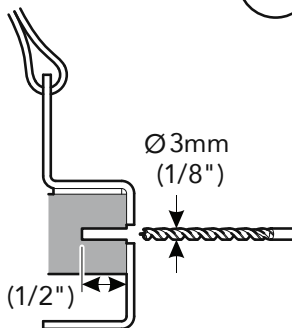

iv

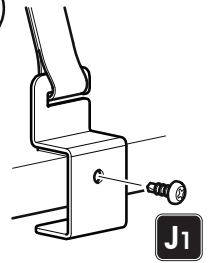

i Remove slack from the straps. Do not over tighten.

5

Securing to Wall

i

Solid Wall

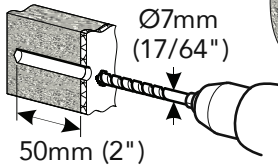
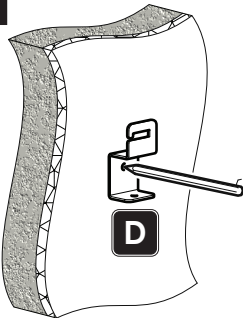

Remove dust from hole.

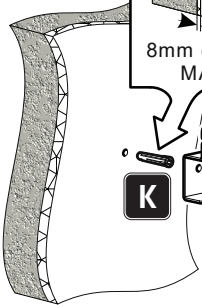
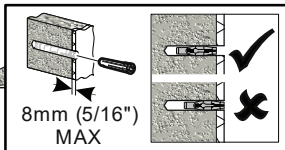

K

J2



J2
x2



K
x2



Lubricate screw thread with soap.



DO NOT over tighten screws. Tighten screws by hand only.

ii

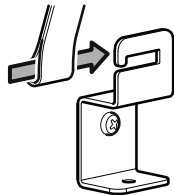

iii

i

Remove slack from the straps. Do not over tighten.

Wood Stud

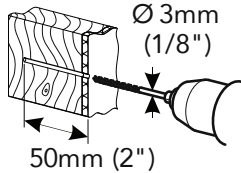
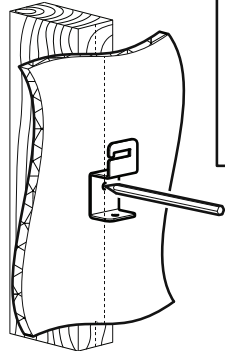
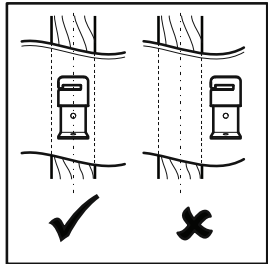

Ensure bracket is in the centre of the wood stud.

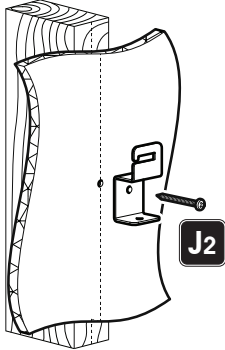

J2

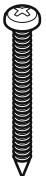

J2
x2

2 YEAR WARRANTY

AVF warrants that the product is free from defects in material and workmanship, as long as the product is owned by the original consumer purchaser. If, during the stated warranty of this product, it proves to be defective, AVF will remedy the defect by either repairing or replacing the defective part or, replacing the entire product. Proof of original purchase is required and should be retained.

AVF reserve the right to substitute replacement products to others of similar value and design (Usually in the event of discontinued product models).

AVF accept no responsibility for failures / loss which result from misuse, negligence, accident, improper assembly or installation or other causes beyond AVF's reasonable control and also excludes and will not pay any incidental and consequential damages.



PLEASE REVIEW ALL NOTES AND PRODUCT INSTRUCTIONS BEFORE COMMENCING THE INSTALLATION.

INSTALLATION: This product is sold as a home DIY product and as such, it is the responsibility of the installer to ensure that the product is correctly installed. AVF accept no responsibility if the product is incorrectly installed.

This product is intended for indoor use only. Use of this product outdoors could lead to failure and personal injury.

IF YOU ARE IN ANY DOUBT, CONSULT A QUALIFIED CONTRACTOR.

NOTES

WALLS: It is the responsibility of the installer to ensure that the wall is of a suitable standard and void of any services (eg gas, electricity, water etc). AVF accept no responsibility for any damage or loss caused by installing this product in a sub standard wall.

WALL FIXINGS: Wall fixings are supplied for wood, brick, solid masonry and also, for some specific products, fixings are supplied for fixing to plasterboard.

DO

- Retain all packaging in case the bracket needs to be returned.
- When fastening to wood studs, be sure to pre-drill holes into the wood stud.
- When fastening to brick or solid masonry, drill the holes in accordance with the instructions. Always remove drill dust from the hole before inserting the wall plug.
- Wall plug body must be fully inserted into the wall (ie fully into the brick).
- Lubricate the wall screws with soap to ease installation.
- Check the strength of the installation before fitting the TV.
- Periodically check strength of installation, signs of corrosion, damage or loose components.

DON'T

- Do not set in mortar joints.
- Do not over tighten screws.

TV HANGING

Must be carried out using the manufacturers threaded holes intended for this purpose. All variables of TV hanging screws are supplied within the product box (Because of the universal nature of this product, expect to have excess parts left over following your installation).

It is the responsibility of the installer to ensure the correct TV hanging screws are selected. If in doubt consult the TV manufacturer. AVF accept no responsibility for any damage caused by the use of the incorrect TV hanging screw or the use of incorrect fixing holes.