



# IMPORTANT!

Aplatir avant l'installation.



# Temium

SKU: 4331680

Notice n°: 470215 rev00

Français

**Vous aurez  
besoin de**

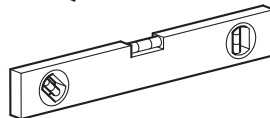
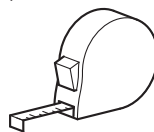
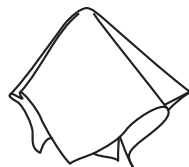

# IMPORTANT!

Le mur doit être propre et sec  
avant l'installation.

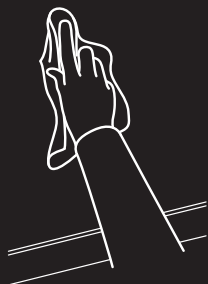

## Guide vidéo



[vimeo.com/462633266](https://vimeo.com/462633266)



### Hotline Darty France

Quels que soient votre panne et le lieu d'achat de votre produit en France, avant de vous déplacer en magasin Darty, appelez le 0 978 970 970 (prix d'un appel local) 7j/7 et 24h/24.

### Hotline Vanden Borre

Le service après-vente est joignable au +32 2 334 00 00, du lundi au vendredi de 8h à 18h et le samedi de 9h à 18h.

### Hotline Fnac France

Quels que soient votre panne et le lieu d'achat de votre produit en France, avant de vous déplacer en magasin Fnac, appelez le 0 969 324 334 du lundi au samedi (8h30-21h00) et le dimanche et jours fériés (10h00-18h00), (prix d'un appel local)

## Pièces incluses

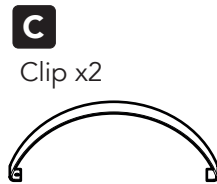
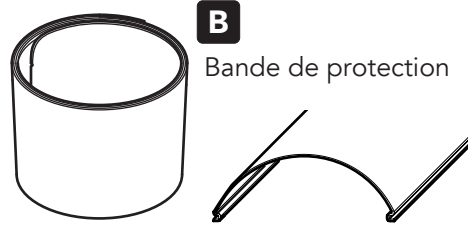
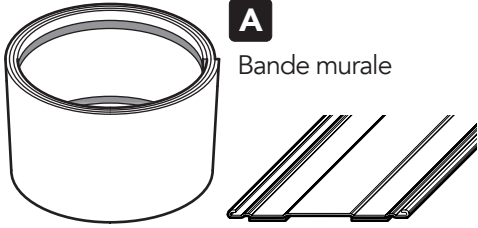

**S'assurer que les bandes A et B sont plates avant de les installer.**

### Pour aplatir :

Dérouler les deux bandes, puis les enrouler dans le sens inverse et les remettre dans l'emballage. Laissez reposer pendant au moins 30 minutes.

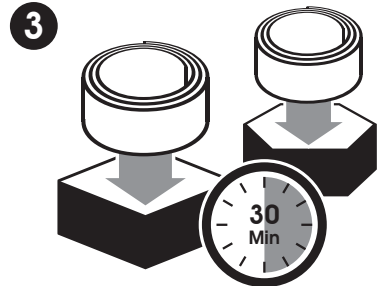
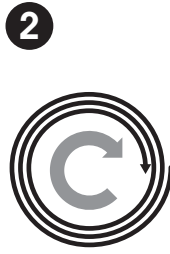
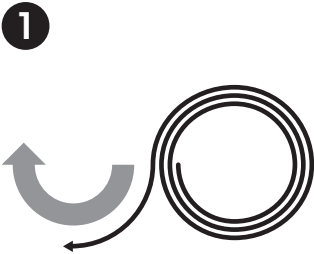

### Conseil

Pour éviter les plis, enrouler d'abord une boucle plus large, puis serrer pour la faire rentrer dans la boîte.



**Pour une meilleure efficacité de l'adhésif, vérifier que le mur est propre et sec.**

Nettoyez soigneusement le mur.

S'assurer que le mur est sec avant l'installation.

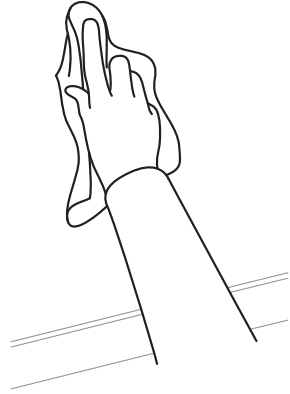

**1**

Mesurer et couper les bandes **A** et **B** en fonction de l'espace requis.

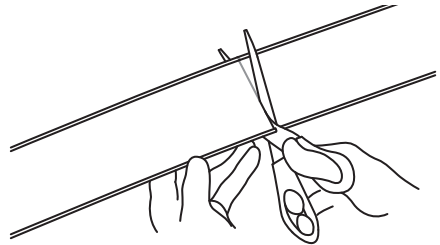
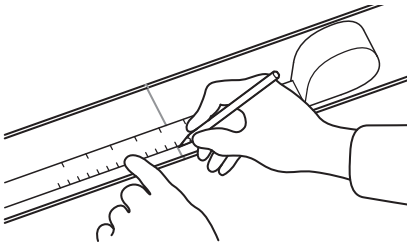

Retirer le papier support des bandes adhésives de la bande murale **A**.

Utiliser un niveau à bulle comme guide et appliquer la bande murale **A** sur le mur.

Utilisez un chiffon propre et sec pour appuyer fermement et frotter le long des canaux.

Cela permettra de créer un lien solide avec votre mur.

Répéter l'opération après 5 minutes.

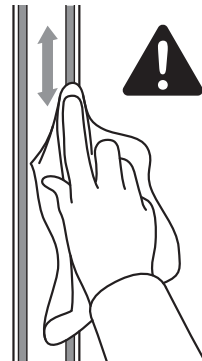
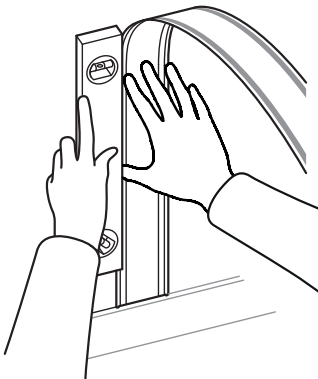

2

Après le positionnement des câbles, accrocher un côté de la bande de couverture **B** à la bande murale **A**.

En partant du haut, presser la bande de protection **B** jusqu'à ce que l'autre côté se fixe en place, ensuite faire glisser le pouce vers le bas jusqu'à ce que le reste de la bande de protection **B** soit fixé en place.

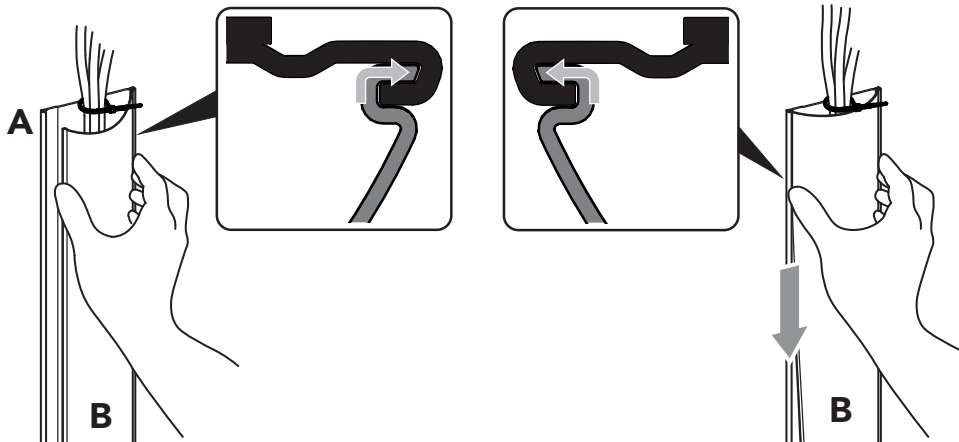

### Conseil

Pour faciliter le maintien des câbles en place lors de la fixation de la bande de protection **B**, il est possible d'enrouler du ruban adhésif, ou d'utiliser un serre-câble, autour de vos câbles en haut et en bas.

3

Fixer la bande de gestion des câbles en haut et en bas à l'aide des clips **C**.

Pousser le clip **C** sur la bande de gestion des câbles. Veiller à ce qu'il se mette en place derrière la bande murale.

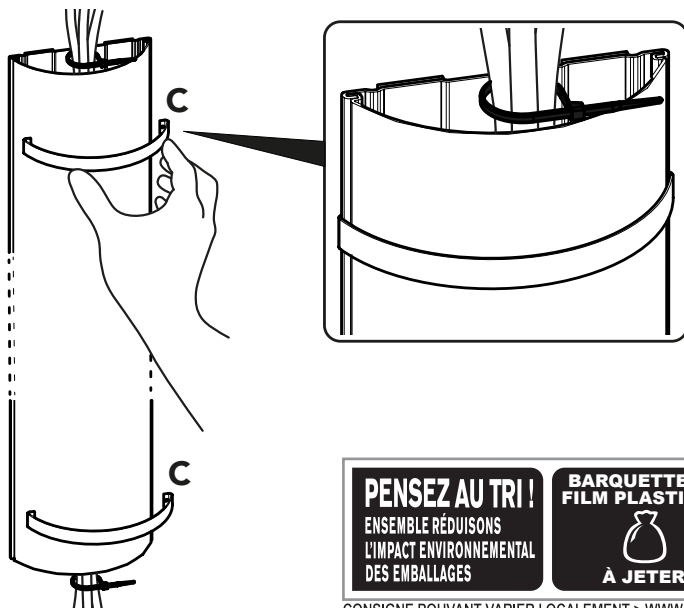

### Touche de finition

Pour une finition professionnelle, peindre votre bande de gestion des câbles en fonction de votre décor.

<b>PENSEZ AU TRI !</b> ENSEMBLE RÉDUISONS L'IMPACT ENVIRONNEMENTAL DES EMBALLAGES	<b>BARQUETTE ET FILM PLASTIQUE</b>  <b>À JETER</b>	<b>ÉTUI CARTON</b>  <b>À RECYCLER</b>
--	---	--





# BELANGRIJK!

Leg vlak neer vóór ophangen.

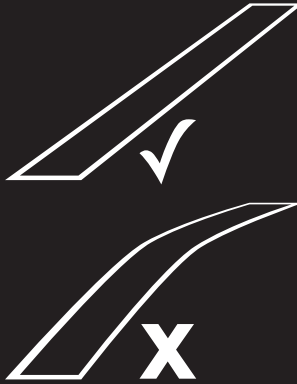

# BELANGRIJK!

De muur moet vóór ophangen  
schoon en droog zijn.



## Wat u nodig heeft

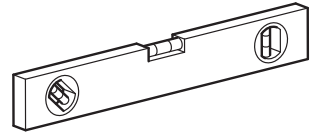
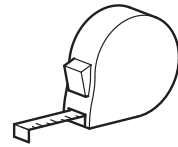
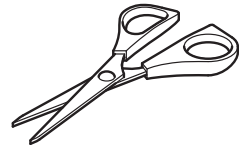
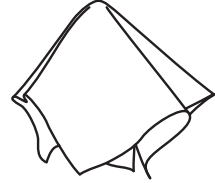

## Video-uitleg



[vimeo.com/462633266](https://vimeo.com/462633266)



### Hotline Vanden Borre

De dienst na verkoop is bereikbaar van  
maandag tot zaterdag op +32 2 334 00 00

### Hulpijn Nederland

Hiervoor kunt u contact opnemen met het BCC Service  
Center: 020 334 88 88. Op werkdagen van 08.00 tot 18.00  
uur en op zaterdag van 09.00 tot 17.00 uur.

## Onderdelen inbegrepen

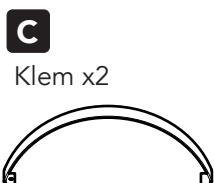
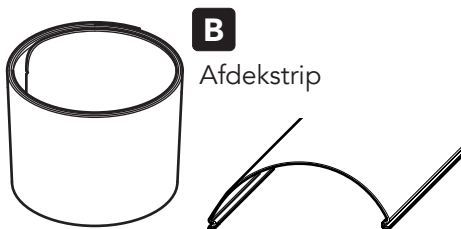
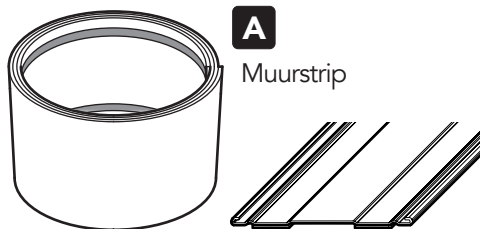

**Zorg ervoor dat de strip A en B vlak liggen voordat u ze ophangt.**

### Vlak neerleggen:

Rol beide stroken uit, rol ze vervolgens weer op in de tegenovergestelde richting en plaats ze terug in de verpakking. Laat minstens 30 minuten intrekken.

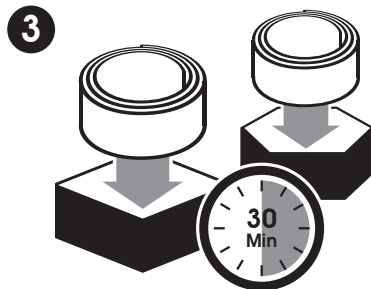
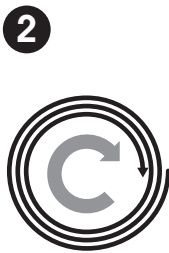
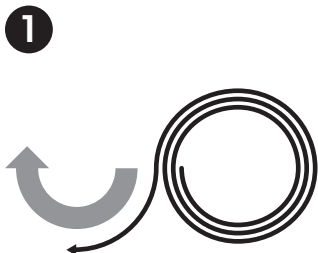

### TIP

Om kreuken te voorkomen, rolt u het eerst wijder uit en trekt u dit vervolgens strak zodat het in de doos past.



Zorg ervoor dat de muur schoon en droog is, zodat de lijm effectief kan werken.

Maak de muur grondig schoon.

Zorg ervoor dat de muur droog is voordat u begint met ophangen.

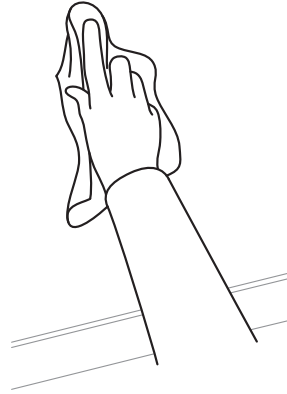

**1** Meet en knip stroken **A** en **B** af zodat ze in de door u gewenste ruimte passen.

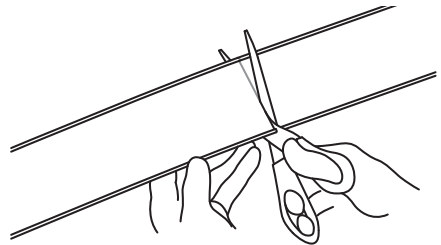
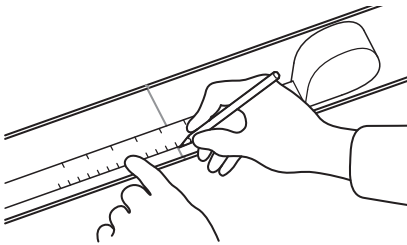

Verwijder de achterkant van de plakstroken van muurstrip **A**.

Gebruik een waterpas als richtlijn en hang muurstrip **A** op aan de muur.

Gebruik een schone, droge doek om stevig langs de kanalen te drukken en te wrijven.

Dit zal helpen om een sterke hechting met uw muur te creëren.

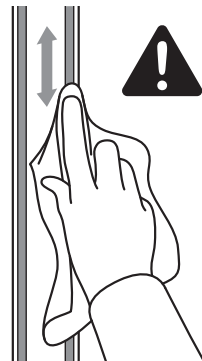
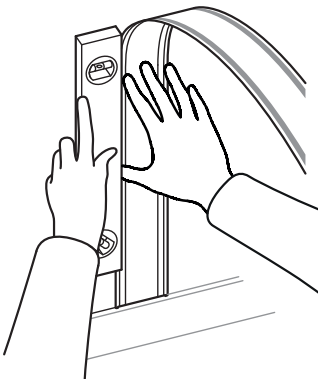

2

Nu de kabels op hun plaats hangen, haakt u één kant van afdekstrip **B** in wandstrip **A**.

Werk van boven naar beneden, knijp afdekstrip **B** in totdat de andere kant op zijn plaats haakt en schuif dan de duim naar beneden totdat de rest van

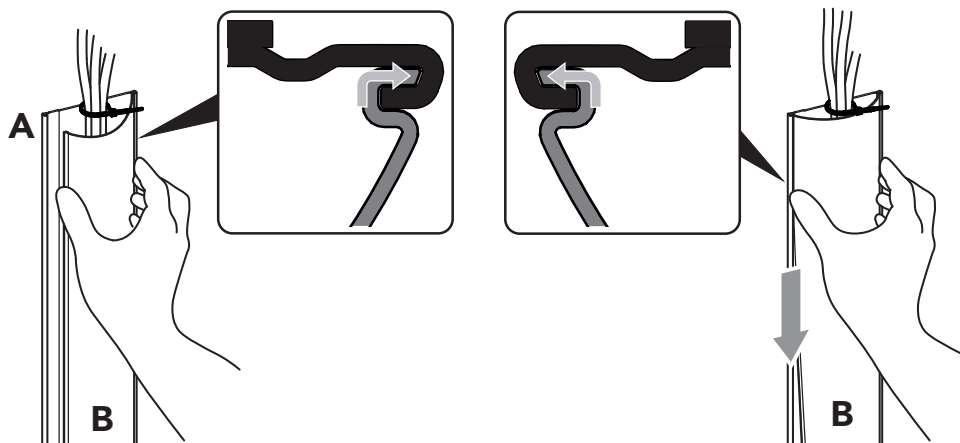

TIP

Om het gemakkelijker te maken om kabels op hun plaats te houden tijdens het bevestigen van afdekstrip **B**, kunt u aan de boven- en onderkant tape of een kabelbinder gebruiken om uw kabels te wikkelen.

3

Zet de kabelgeleiderstrip aan de boven- en onderkant vast met klemmen **C**.

Duw klem **C** over de kabelgeleider. Zorg ervoor dat hij op zijn plaats klikt achter de muurstrip.

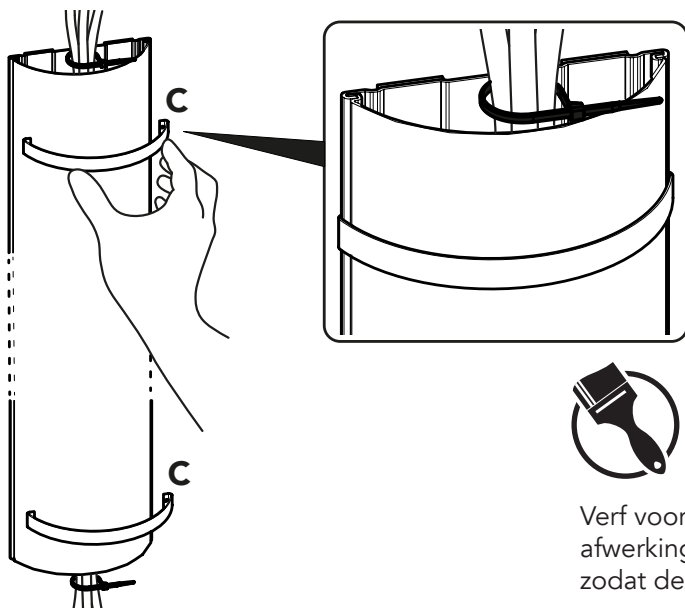

**Kers op de taart**

Verf voor een professionele afwerking uw kabelgeleiders zodat deze bij uw interieur passen.





# IMPORTANT!

Flatten before installation.

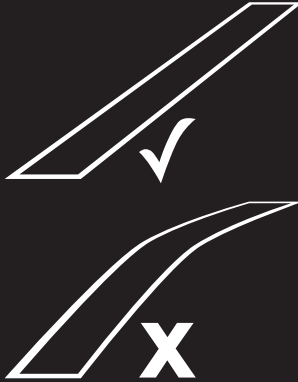

## You will need

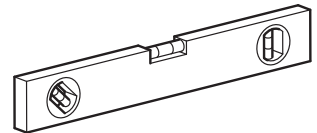
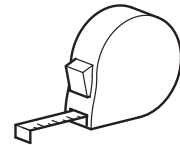
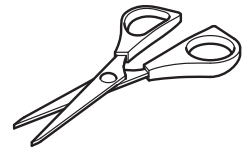
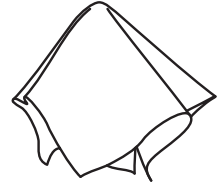

# IMPORTANT!

Wall must be clean and dry before installation.



**Video Guide**



[vimeo.com/462633266](https://vimeo.com/462633266)



# Parts Included

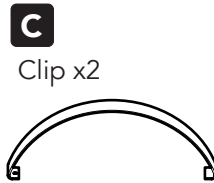
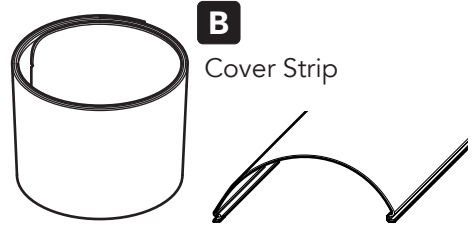
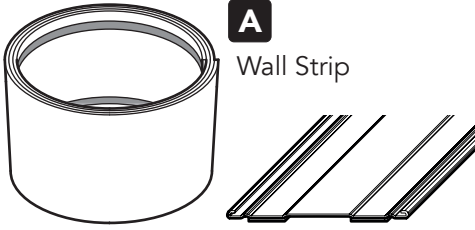

**Ensure strips A and B are flat before installing**

## To Flatten:

Unroll both strips, then roll back up in the opposite direction and place back in the packaging. Leave for at least 30 minutes.

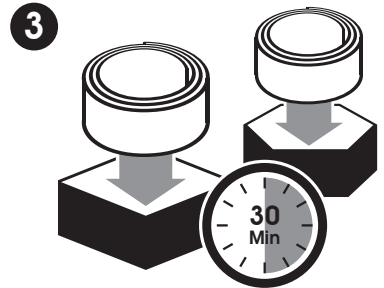
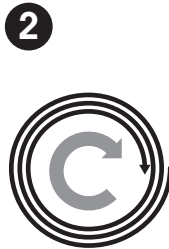
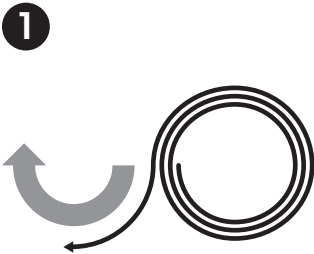

**TIP** To avoid creasing, first roll a wider loop, then tighten to fit inside box.



**For adhesive to be effective ensure wall is clean and dry**

Clean the wall thoroughly.

Make sure the wall is dry before installation.

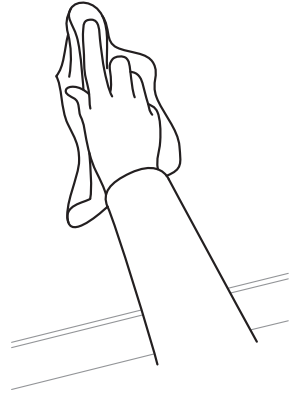

**1**

Measure and cut strips **A** and **B** to fit your required space.

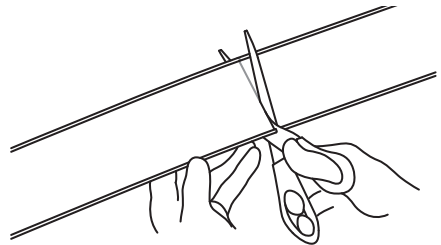
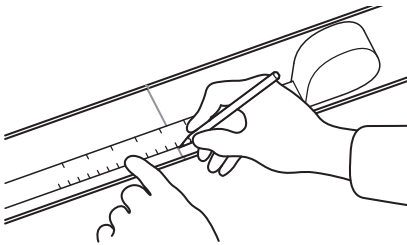

Remove backing paper from adhesive strips on Wall Strip **A**.

Use a spirit level as a guide and apply Wall Strip **A** to the wall.

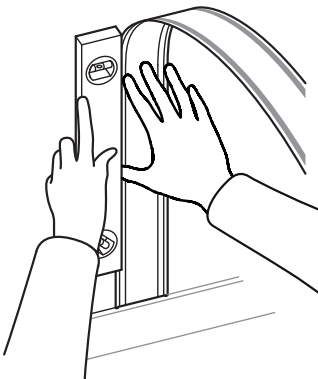

Use a clean, dry cloth to firmly press and rub along the channels.

This will help create a strong bond with your wall.

Repeat after 5 minutes.

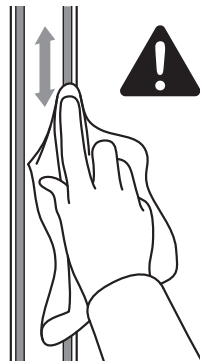

2

With cables in place, hook one side of Cover Strip **B** into Wall Strip **A**.

Working from the top, squeeze Cover Strip **B** until the other side hooks into place, then slide thumb downwards until the rest of Cover Strip **B** is hooked into place.

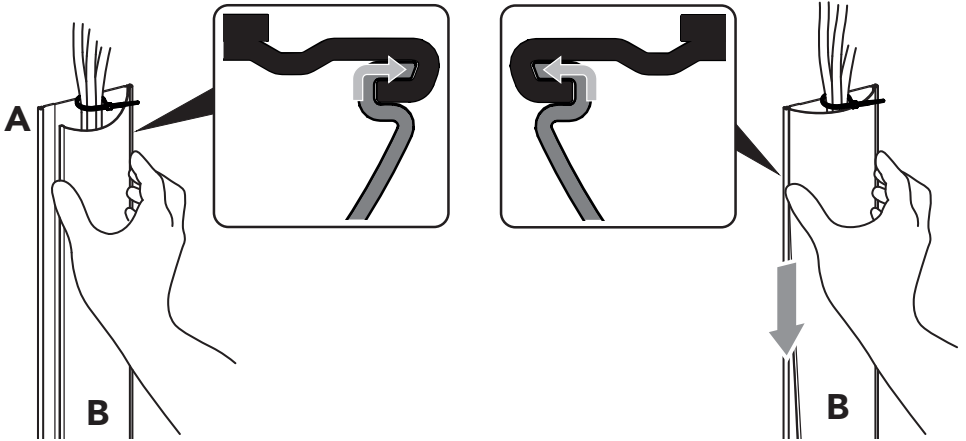

TIP

To make it easier to keep cables in place while attaching Cover Strip **B**, you can wrap tape, or use a cable tie, around your cables at the top and bottom.

3

Secure the cable management strip at the top and bottom using clips **C**.

Push clip **C** over the cable management strip. Make sure it clips into place behind the wall strip.

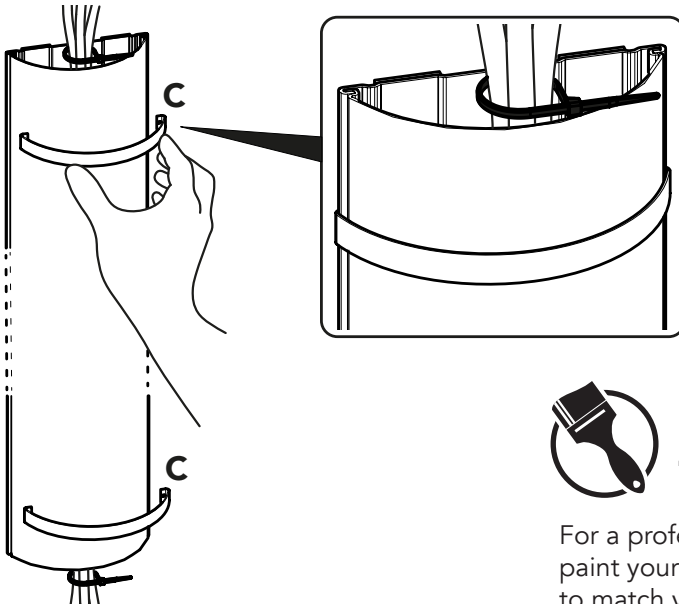

### Finishing Touch

For a professional finish, paint your cable management to match your decor.



# ¡IMPORTANTE!

Aplanar antes de la instalación.

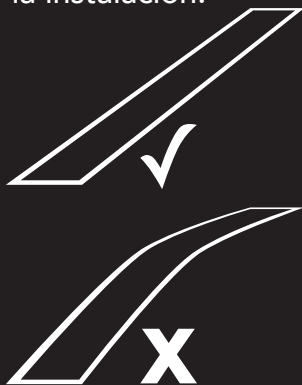

# ¡IMPORTANTE!

La pared debe estar limpia y seca antes de la instalación.



## Necesitará

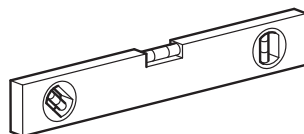
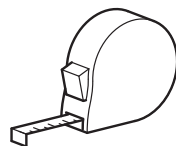
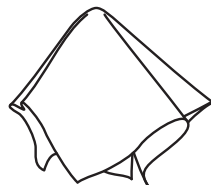

Videoguía



[vimeo.com/462633266](https://vimeo.com/462633266)



## Piezas incluidas

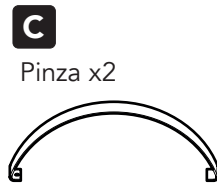
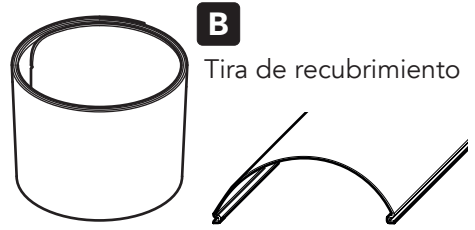

**Asegúrese de que las tiras A y B estén planas antes de instalar.**

### Para aplanar:

Desenrolle ambas tiras, luego vuelva a enrollarlas en la dirección opuesta y vuelva a colocarlas en el embalaje. Deje actuar al menos 30 minutos.

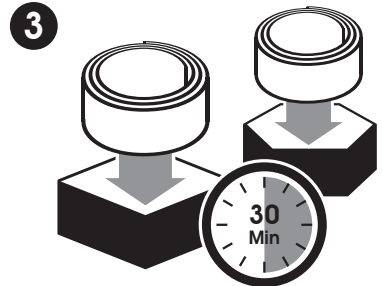
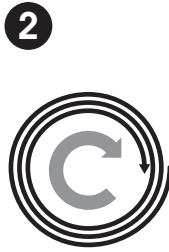
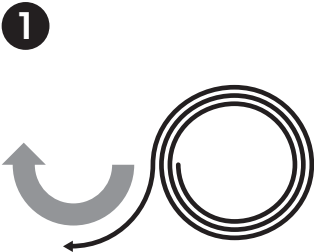

### Consejo

Para evitar arrugas, enrolle primero un bucle más ancho y apriételo para que quepa dentro de la caja.



Para que el adhesivo sea eficaz, asegúrese de que la pared esté limpia y seca.

Limpie la pared exhaustivamente.

Asegúrese de que la pared esté seca antes de la instalación.

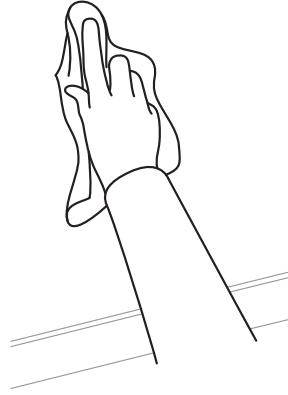

1

Mida y corte las tiras **A** y **B** para que se ajusten al espacio necesario.

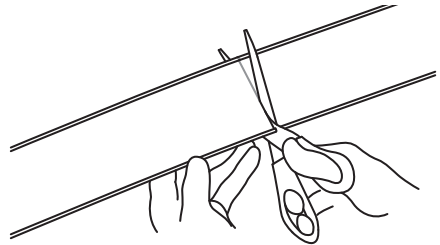
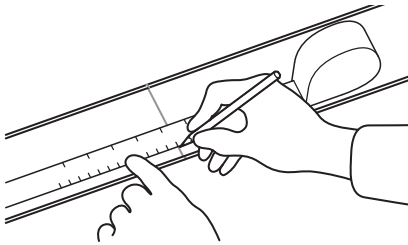

Retire el papel protector de las tiras adhesivas en la tira de pared **A**.

Utilice un nivel de burbuja como guía y aplique la tira de pared **A** a la pared.

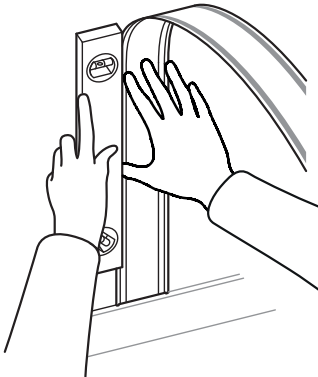

Use un paño limpio y seco para presionar firmemente y frotar a lo largo de los canales.

Así ayudará a generar una adherencia fuerte con la pared.

Repítalo después de 5 minutos.

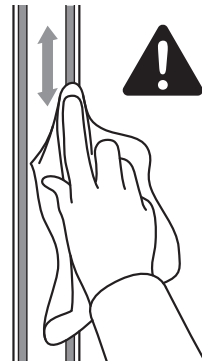

2

Con los cables en su lugar, enganche un lado de la tira de recubrimiento **B** en la tira de pared **A**.

Desde la parte superior, presione la tira de recubrimiento **B** hasta que el otro lado se enganche en su lugar, luego deslice el pulgar hacia abajo hasta que el resto de la tira de recubrimiento **B** quede enganchada en su lugar.

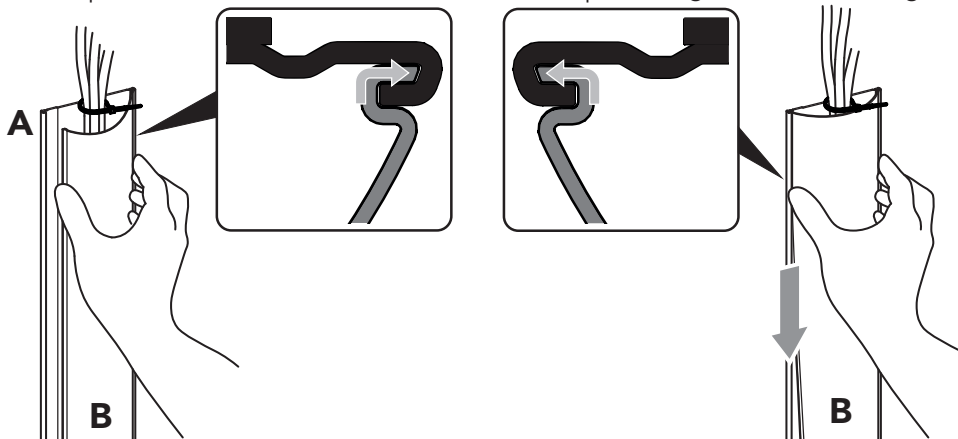

### Consejo

Para que sea más fácil mantener los cables en su lugar mientras coloca la tira de recubrimiento **B**, puede envolver cinta o usar una brida para cables alrededor de los cables en la parte superior e inferior.

3

Asegure la tira del organizador de cables en la parte superior e inferior con las pinzas **C**.

Empuje la pinza **C** sobre la tira del organizador de cables. Asegúrese de que se sujete en su lugar detrás de la tira de pared.

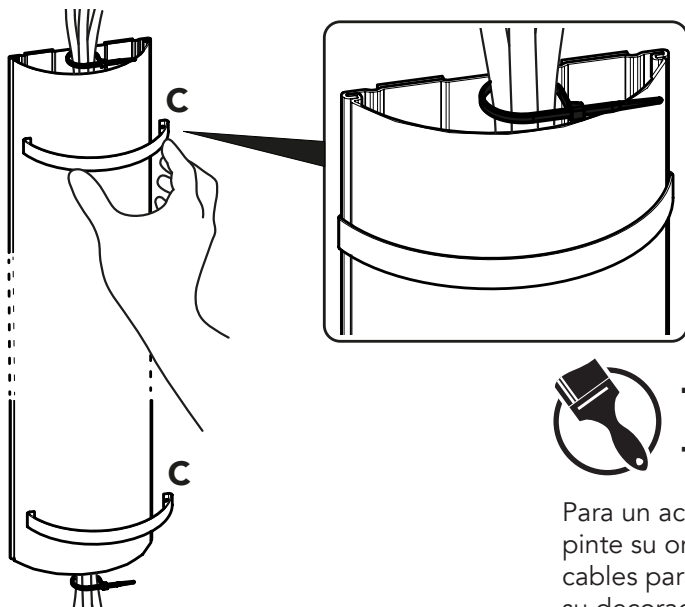

### Toque final

Para un acabado profesional, pinte su organizador de cables para que combine con su decoración.





# IMPORTANTE!

Aplanar antes da instalação.

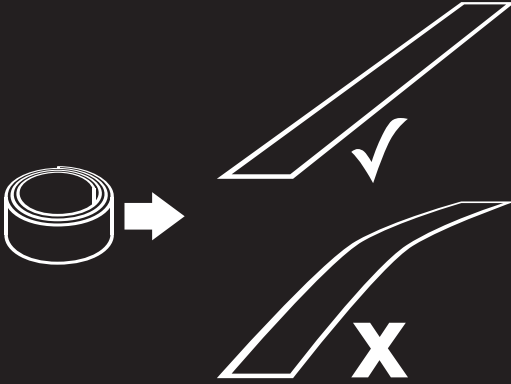

Precisará de

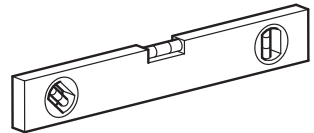
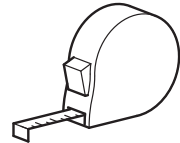
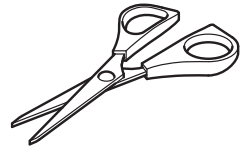
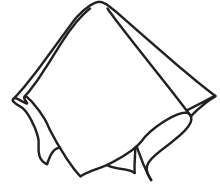

# IMPORTANTE!

A parede deve estar limpa e seca antes da instalação.



Guia de Vídeo



[vimeo.com/462633266](https://vimeo.com/462633266)



## Peças Incluídas



**Certifique-se de que as faixas A e B estão planas antes da instalação.**

### Para Aplanar:

Desenrole ambas as faixas, depois enrole de novo na direção oposta e coloque de volta na embalagem. Deixe durante pelo menos 30 minutos.

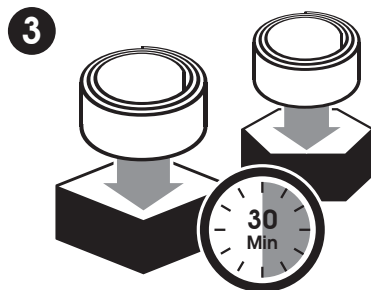
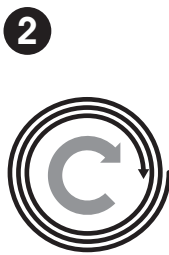
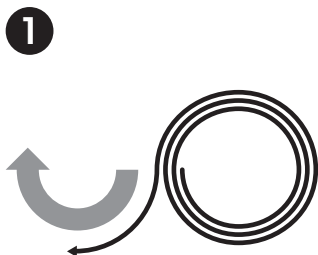

### DICA

Para evitar fazer dobras, primeiro enrole um laço mais amplo, depois aperte para caber dentro da caixa.



**Para que o adesivo seja eficaz, certifique-se de que a parede está limpa e seca.**

Limpe completamente a parede.

Certifique-se de que a parede está seca antes da instalação.

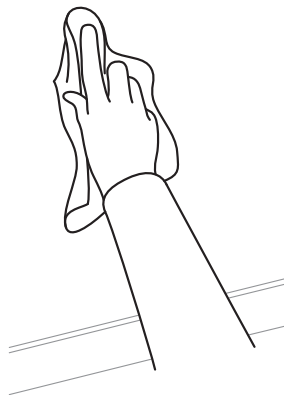

**1**

Meça e corte as faixas **A** e **B** para encaixarem no espaço exigido.

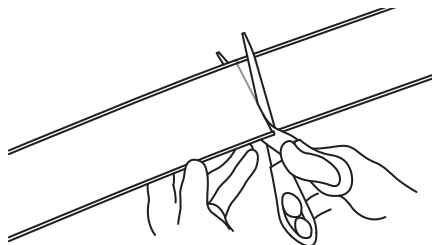
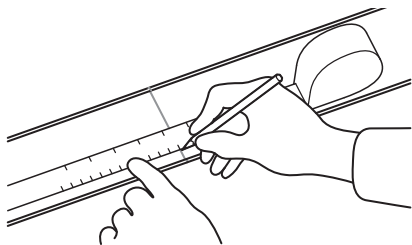

Remova o papel de suporte das faixas adesivas na Faixa de Parede **A**.

Utilize um nível como um guia e aplique a Faixa de Parede **A** à parede.

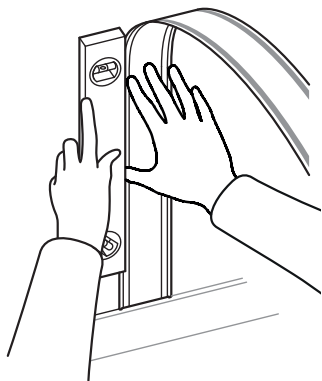

Utilize um pano limpo e seco para pressionar e esfregar firmemente ao longo dos canais.

Isto ajudará a criar uma ligação forte com a sua parede.

Repita após 5 minutos.

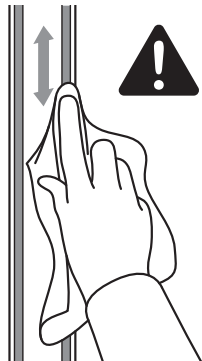

2

Com os cabos no lugar, prenda um lado da Faixa de Cobertura **B** na Faixa de Parede **A**.

Trabalhando a partir de cima, aperte a Faixa de Cobertura **B** até que o outro lado fique preso no lugar, depois deslize o polegar para baixo até que o resto da Faixa de Cobertura **B** fique preso no lugar.

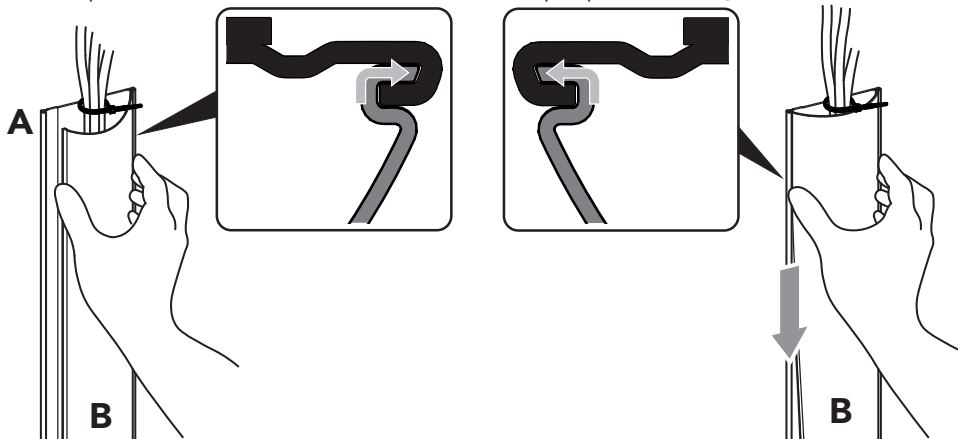

**DICA**

Para facilitar a manutenção dos cabos enquanto fixa a Faixa de Cobertura **B**, pode enrolar a fita adesiva, ou utilizar uma braçadeira, à volta dos seus cabos na parte superior e inferior.

3

Segure a faixa da gestão de cabos em cima e em baixo utilizando os grampos **C**.

Empurre o Grampo **C** sobre a faixa de gestão de cabos. Certifique-se de que fica preso no lugar por detrás da faixa de parede.

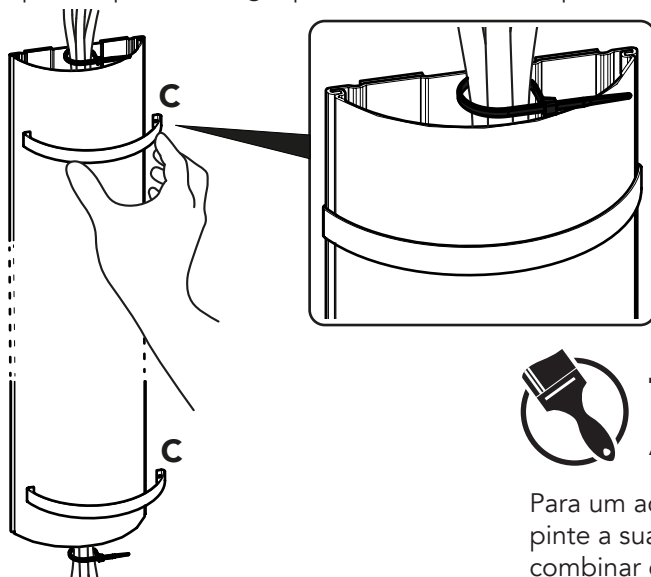

### Toque de Acabamento

Para um acabamento profissional, pinte a sua gestão de cabos para combinar com a sua decoração.