

470093 rev00
Español

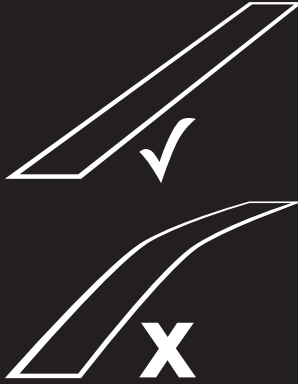

¡IMPORTANTE!

Aplanar antes de
la instalación.



Necesitará

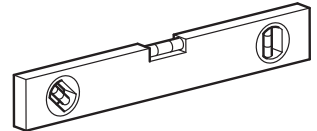
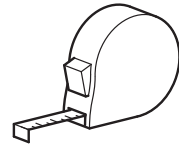
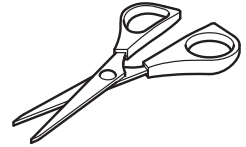
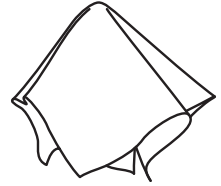

¡IMPORTANTE!

La pared debe estar limpia
y seca antes de la instalación.



Videoguía



vimeo.com/462633266



+44 (0) 333 320 0463 (UK)
1-800 667 0808 (USA)

Piezas incluidas

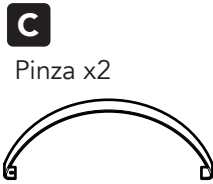

Asegúrese de que las tiras A y B estén planas antes de instalar.

Para aplanar:

Desenrolle ambas tiras, luego vuelva a enrollarlas en la dirección opuesta y vuelva a colocarlas en el embalaje. Deje actuar al menos 30 minutos.

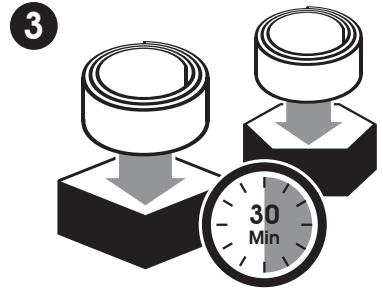
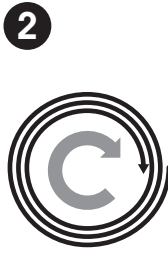
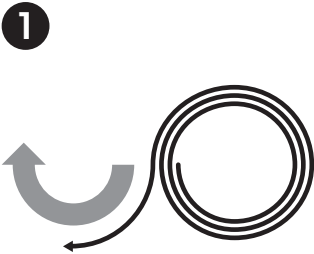

Consejo

Para evitar arrugas, enrolle primero un bucle más ancho y apriételo para que quepa dentro de la caja.



Para que el adhesivo sea eficaz, asegúrese de que la pared esté limpia y seca.

Limpie la pared a fondo con las toallitas **D** que se incluyen.

Asegúrese de que la pared esté seca antes de la instalación.

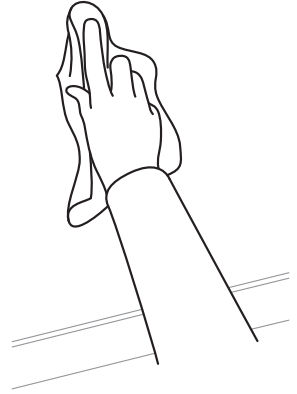
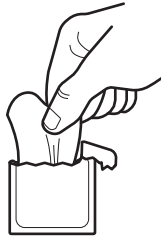

1

Mida y corte las tiras **A** y **B** para que se ajusten al espacio necesario.

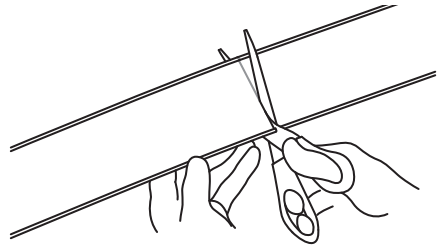
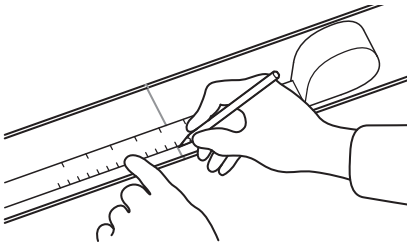

Retire el papel protector de las tiras adhesivas en la tira de pared **A**.

Utilice un nivel de burbuja como guía y aplique la tira de pared **A** a la pared.

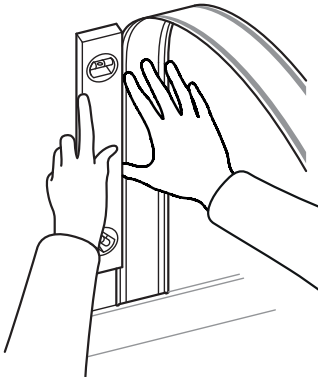

Use un paño limpio y seco para presionar firmemente y frotar a lo largo de los canales.

Así ayudará a generar una adherencia fuerte con la pared.

Repítalo después de 5 minutos.

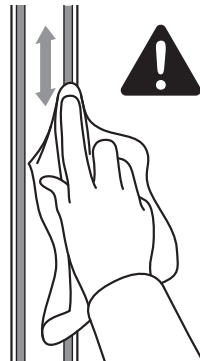

2

Con los cables en su lugar, enganche un lado de la tira de recubrimiento **B** en la tira de pared **A**.

Desde la parte superior, presione la tira de recubrimiento **B** hasta que el otro lado se enganche en su lugar, luego deslice el pulgar hacia abajo hasta que el resto de la tira de recubrimiento **B** quede enganchada en su lugar.

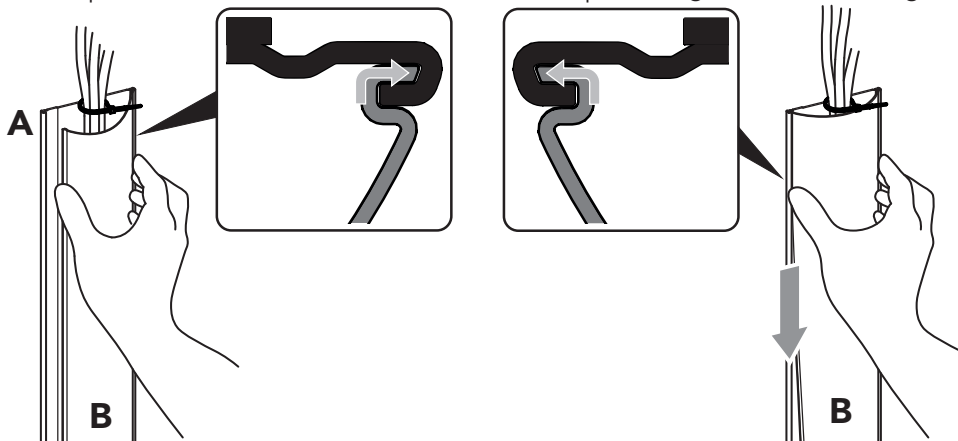

Consejo

Para que sea más fácil mantener los cables en su lugar mientras coloca la tira de recubrimiento **B**, puede envolver cinta o usar una brida para cables alrededor de los cables en la parte superior e inferior.

3

Asegure la tira del organizador de cables en la parte superior e inferior con las pinzas **C**.

Empuje la pinza **C** sobre la tira del organizador de cables. Asegúrese de que se sujete en su lugar detrás de la tira de pared.

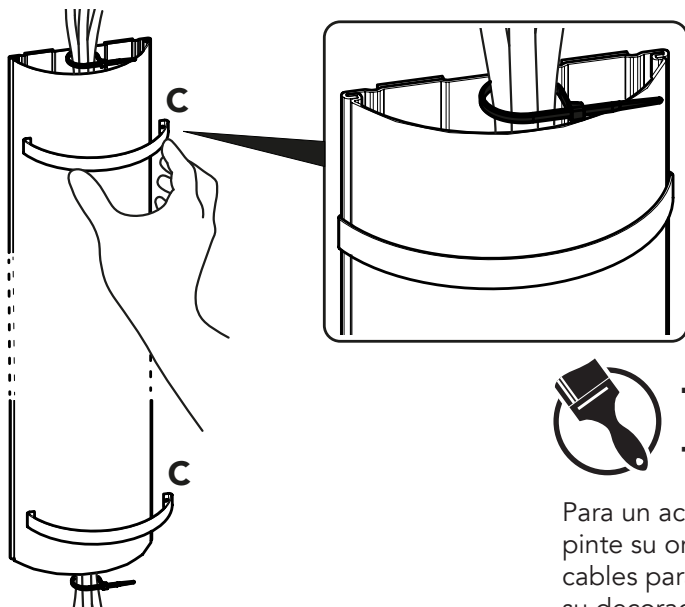

Toque final

Para un acabado profesional, pinte su organizador de cables para que combine con su decoración.

470093 rev00
Français



IMPORTANT!

Aplatir avant l'installation.

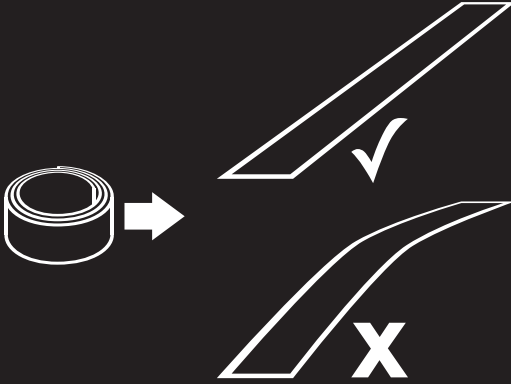

**Vous aurez
besoin de**

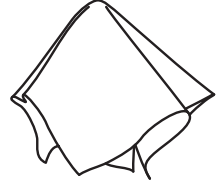

IMPORTANT!

Le mur doit être propre et sec
avant l'installation.

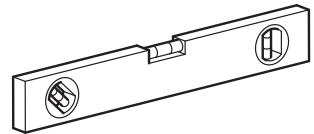
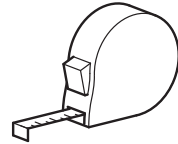
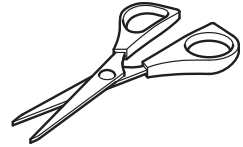
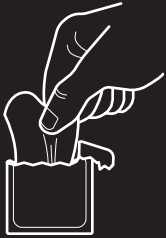

Guide vidéo



vimeo.com/462633266



**+44 (0) 333 320 0463 (UK)
1-800 667 0808 (USA)**

Pièces incluses

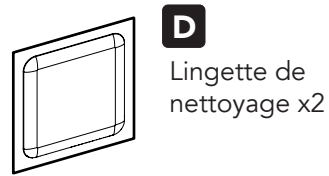
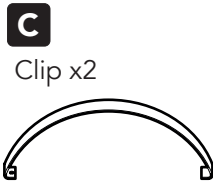
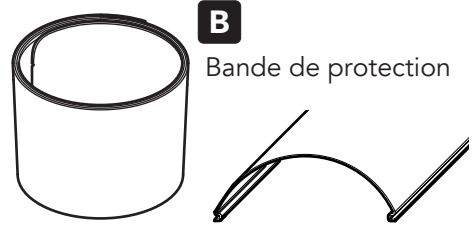
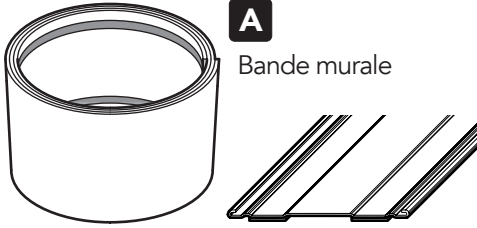

S'assurer que les bandes A et B sont plates avant de les installer.

Pour aplatir :

Dérouler les deux bandes, puis les enrouler dans le sens inverse et les remettre dans l'emballage. Laissez reposer pendant au moins 30 minutes.

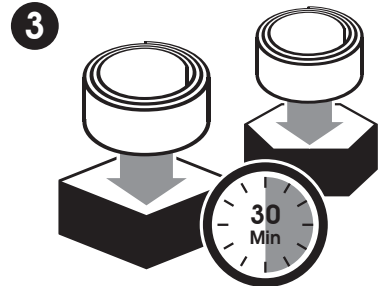
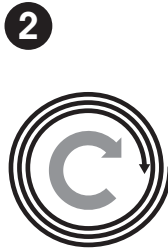
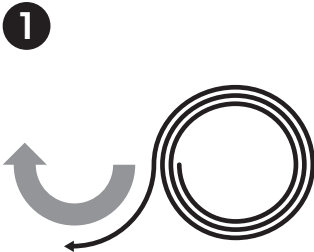

Conseil

Pour éviter les plis, enrouler d'abord une boucle plus large, puis serrer pour la faire rentrer dans la boîte.



Pour une meilleure efficacité de l'adhésif, vérifier que le mur est propre et sec.

Nettoyez soigneusement le mur à l'aide des lingettes **D** fournies.

S'assurer que le mur est sec avant l'installation.

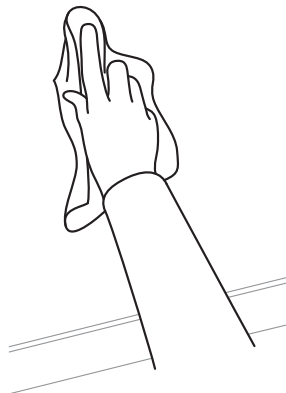

1 Mesurer et couper les bandes **A** et **B** en fonction de l'espace requis.

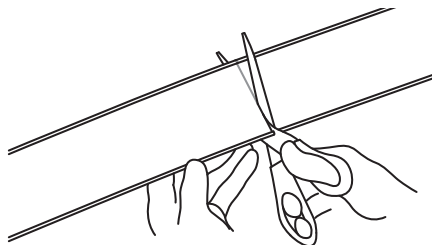
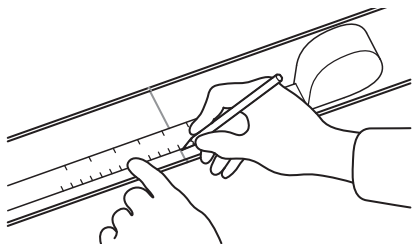

Retirer le papier support des bandes adhésives de la bande murale **A**.

Utiliser un niveau à bulle comme guide et appliquer la bande murale **A** sur le mur.

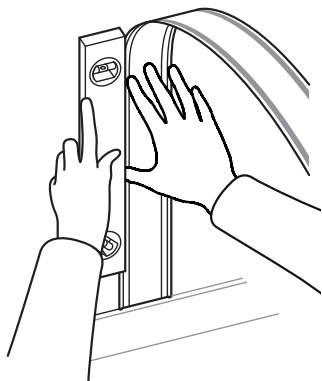

Utilisez un chiffon propre et sec pour appuyer fermement et frotter le long des canaux.

Cela permettra de créer un lien solide avec votre mur.

Répéter l'opération après 5 minutes.

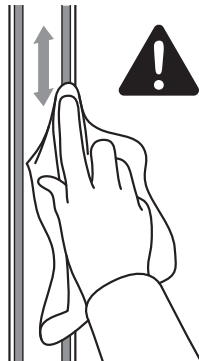

2

Après le positionnement des câbles, accrocher un côté de la bande de couverture **B** à la bande murale **A**.

En partant du haut, presser la bande de protection **B** jusqu'à ce que l'autre côté se fixe en place, ensuite faire glisser le pouce vers le bas jusqu'à ce que le reste de la bande de protection **B** soit fixé en place.

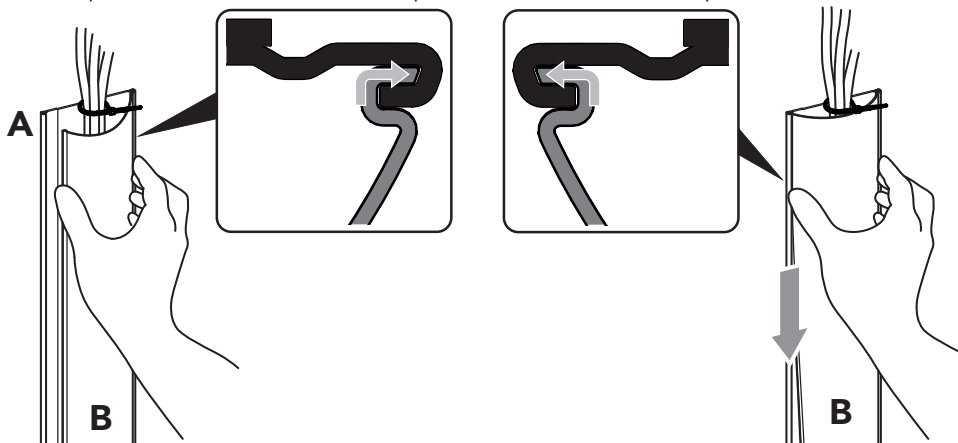

Conseil

Pour faciliter le maintien des câbles en place lors de la fixation de la bande de protection **B**, il est possible d'enrouler du ruban adhésif, ou d'utiliser un serre-câble, autour de vos câbles en haut et en bas.

3

Fixer la bande de gestion des câbles en haut et en bas à l'aide des clips **C**.

Pousser le clip **C** sur la bande de gestion des câbles. Veiller à ce qu'il se mette en place derrière la bande murale.

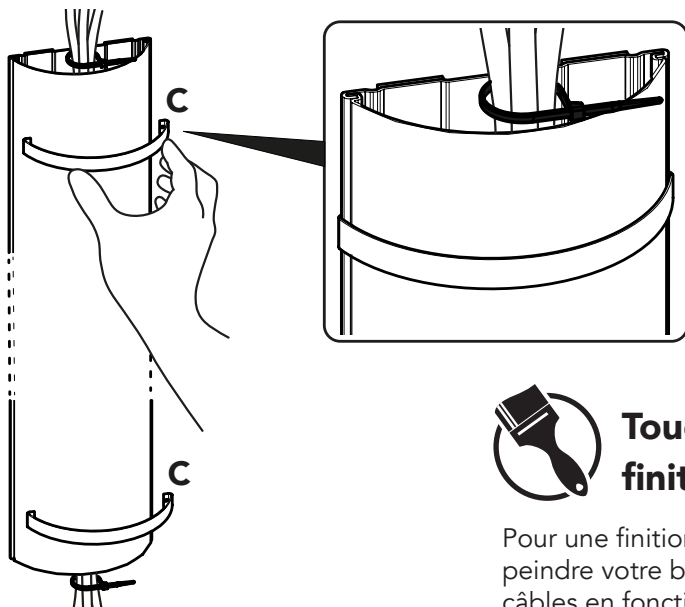

Touche de finition

Pour une finition professionnelle, peindre votre bande de gestion des câbles en fonction de votre décor.

470093 rev00
Deutsche



WICHTIG!

Vor der Montage ebnen.

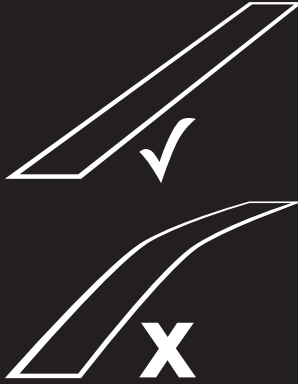

Sie brauchen

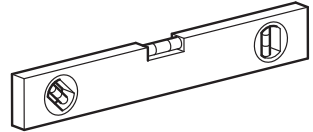
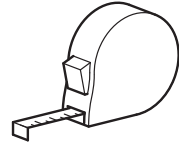
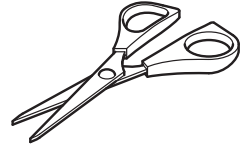
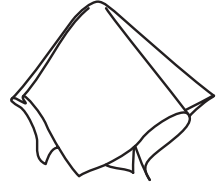

WICHTIG!

Die Wand sollte vor der
Montage sauber und
trocken sein.



Videoanleitung



vimeo.com/462633266



+44 (0) 333 320 0463 (UK)
1-800 667 0808 (USA)

Mitgelieferte Teile

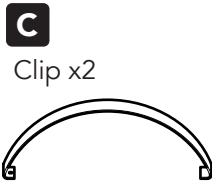
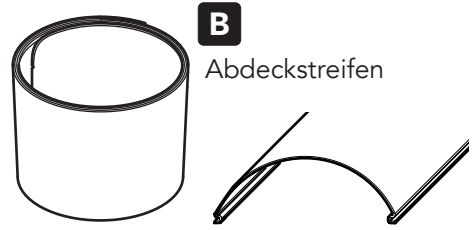

Vergewissern Sie sich, dass die Streifen A und B vor der Montage eben sind.

Zum Ebnen:

Beide Streifen abrollen, dann in umgekehrter Richtung wieder aufrollen und zurück in die Verpackung legen. Mindestens 30 Minuten warten.

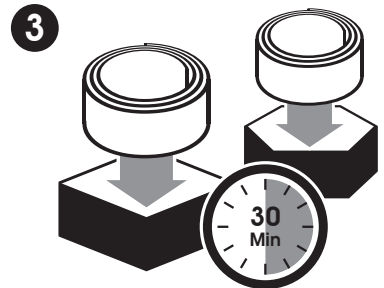
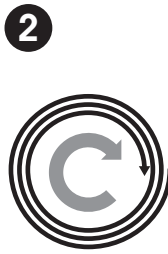
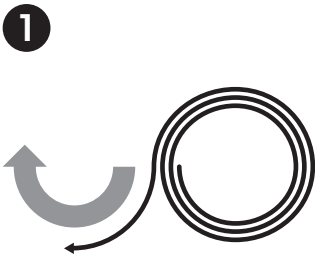

TIPP

Um Knicke zu vermeiden, zuerst eine lose Rolle drehen und dann so festziehen, dass sie in die Box passt.



Für einen wirksamen Klebeeﬀekt sollte die Wand sauber und trocken sein.

Reinigen Sie die Wand sorgfältig mit den mitgelieferten Tüchern **D**.

Vergewissern Sie sich vor der Montage, dass die Wand trocken ist.

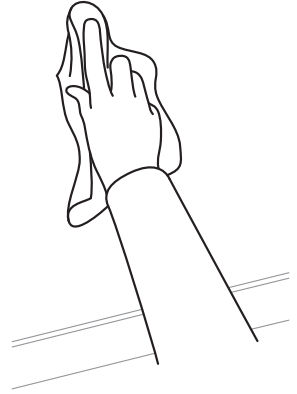

1 Messen und schneiden Sie die Streifen **A** und **B** auf den gewünschten Platz zu.

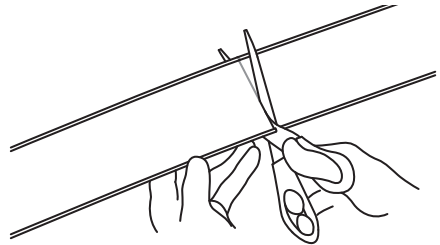
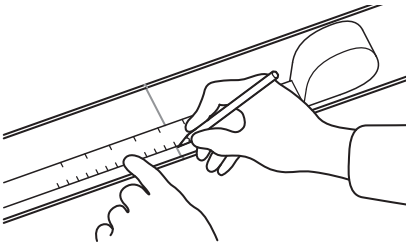

Entfernen Sie das Schutzpapier von den Klebestreifen des Wandstreifens **A**.

Benutzen Sie zur Ausrichtung eine Wasserwaage und befestigen Sie den Wandstreifen **A** an der Wand.

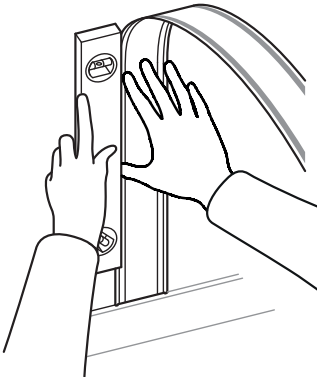

Drücken Sie die Kanäle mit einem sauberen, trockenen Tuch kräftig an und wischen Sie damit fest an ihnen entlang.

So schaffen Sie eine starke Haftung an Ihrer Wand.

Wiederholen Sie dies nach 5 Minuten.

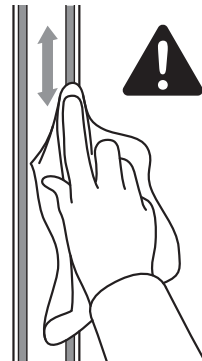

2

Nachdem die Kabel eingesetzt sind, haken Sie eine Seite des Abdeckstreifens **B** in den Wandstreifen **A** ein.

Drücken Sie den Abdeckstreifen **B** von oben beginnend an, bis die andere Seite einrastet und schieben Sie dann den Daumen nach unten, bis der Rest des Abdeckstreifens **B** eingerastet ist.

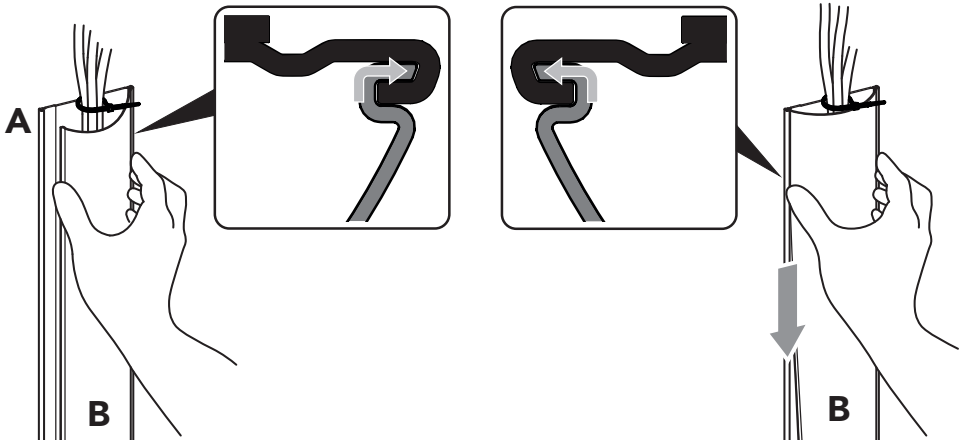

TIPP

Um die Kabel beim Anbringen des Abdeckstreifens **B** leichter in Position zu halten, können Sie sie oben und unten mit Klebeband oder einem Kabelbinder fixieren.

3

Sichern Sie die Kabelführungstreifen oben und unten mit den Clips **C**.

Drücken Sie Clip **C** auf den Kabelführungstreifen. Achten Sie darauf, dass er hinter dem Wandstreifen einrastet.

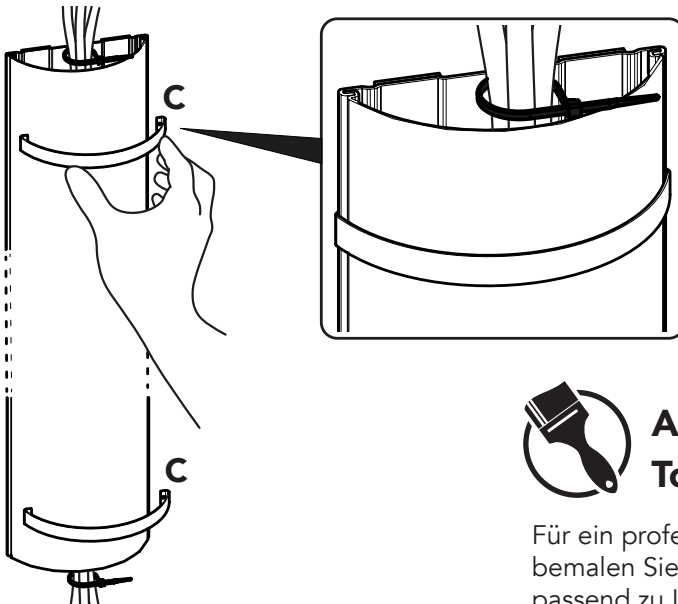

Abschließender Touch

Für ein professionelles Finish bemalen Sie ihre Kabelführung passend zu Ihrem Interieur.

470093 rev00
Italiano



IMPORTANTE!

Appiattare prima
dell'applicazione

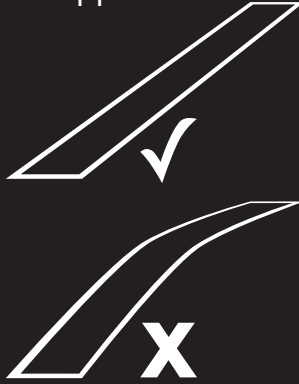

**Avrai bisogno del
seguito materiale**

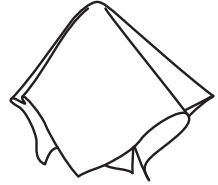

IMPORTANTE!

Il muro dovrà essere pulito e
asciugato prima dell'applicazione.

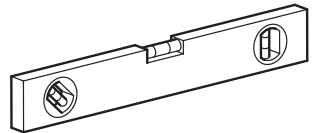
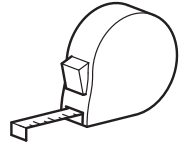
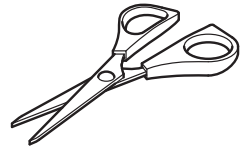

Videoguida



vimeo.com/462633266



+44 (0) 333 320 0463 (UK)
1-800 667 0808 (USA)

Contenuto

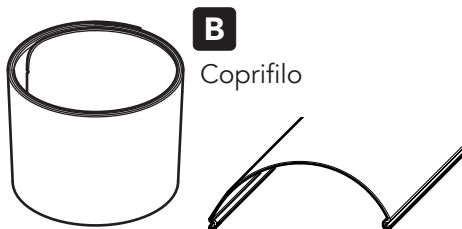

Assicurati che i bordi A e B siano appiattiti prima di applicarli.

Per appiattire:

Srotola entrambe le strisce, riavvolgile nella direzione opposta e poi riponile nella confezione per circa 30 minuti.

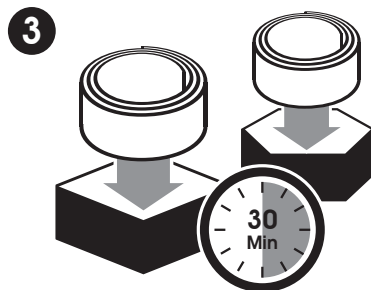
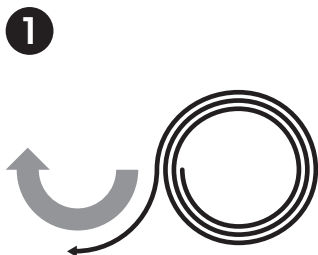

SUGGERIMENTO

Per evitare sgualciture, avvolgi i bordi eseguendo prima un giro ampio e poi uno più stretto per collocarli nella confezione.



Affinché l'adesivo aderisca bene alla parete, assicurati che sia ben pulita e asciutta.

Pulisci la parete accuratamente utilizzando il panno **D** incluso nella confezione.

Assicurati che la parete sia asciutta prima di effettuare l'applicazione.

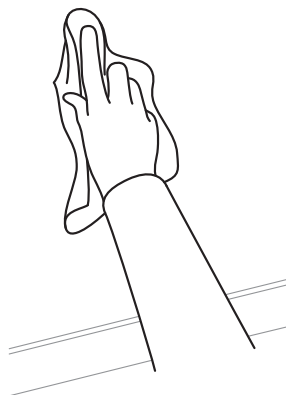

1 Misura e poi taglia i bordi **A** e **B** secondo lo spazio a te necessario.

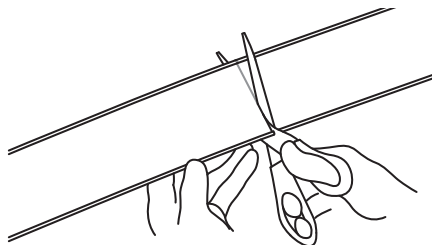
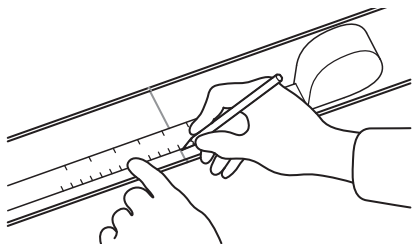

Rimuovi la pellicola di carta posta sul retro della striscia adesiva del Bordo da parete **A**.

Utilizza la livella come guida e applica il Bordo da parete **A** sulla parete.

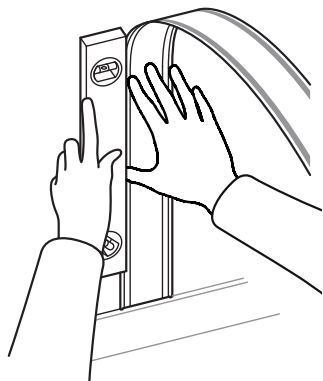

Passa un panno pulito e asciutto lungo le scanalature, esercitando un'energica pressione.

In tal modo, aderirà saldamente alla parete.

Ripeti l'operazione dopo 5 minuti.

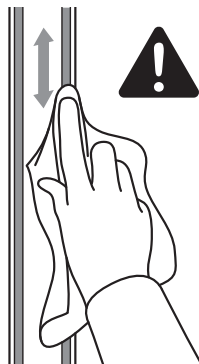

2

Con i cavi in posizione, collega un lato del Bordo da parete **B** a quello **A**.

Partendo dalla sommità, comprimi il Bordo da parete **B** fino a quando l'altro lato non sarà fissato in posizione, poi lascia scivolare il pollice verso il basso fino a quando il resto del Coprifilo **B** non sarà anch'esso fissato in posizione.

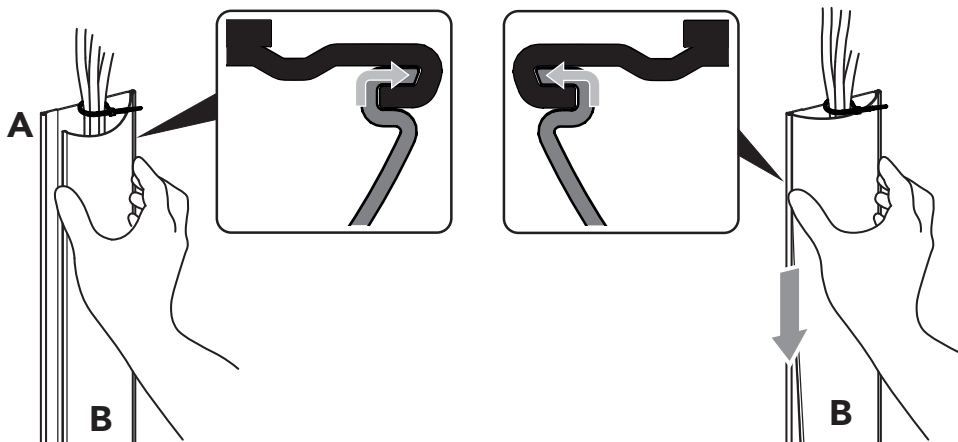

SUGGERIMENTO

Per mantenere più facilmente in cavi nella loro posizione mentre colleghi il Coprifilo **B**, avvolgi del nastro adesivo (oppure delle fascette) attorno alla sommità e alla base dei cavi.

3

Fissa la striscia passacavi alla sommità e alla base utilizzando il morsetto **C**.

Premi il morsetto **C** sopra la striscia passacavi. Assicurati che si agganci in posizione dietro il Bordo da parete.

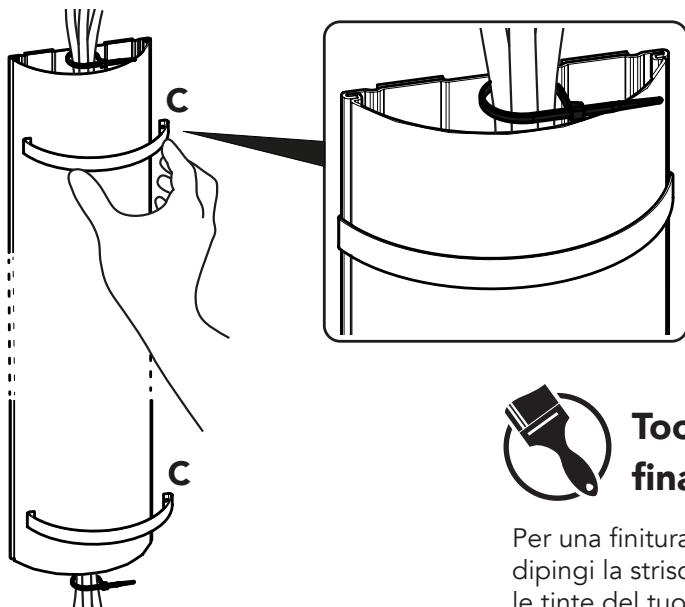

**Tocco
finale**

Per una finitura professionale, dipingi la striscia passacavi secondo le tinte del tuo arredamento.

470093 rev00
Portoghese



IMPORTANTE!

Aplanar antes da instalação.

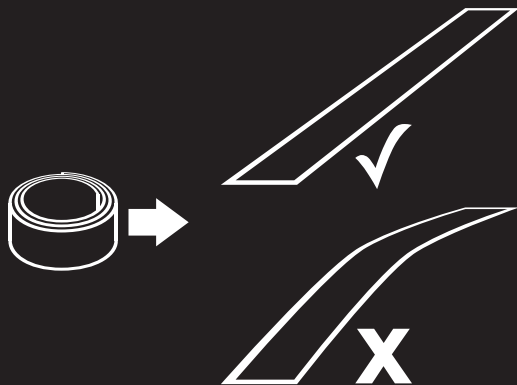

Precisará de

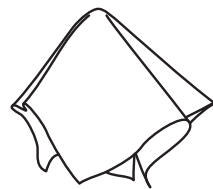

IMPORTANTE!

A parede deve estar limpa e
seca antes da instalação.

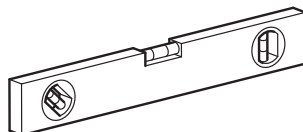
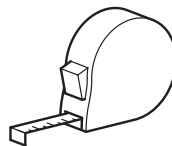
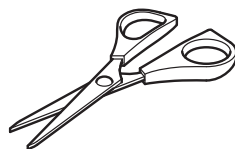

Guia de Vídeo



vimeo.com/462633266



+44 (0) 333 320 0463 (UK)
1-800 667 0808 (USA)

Peças Incluídas

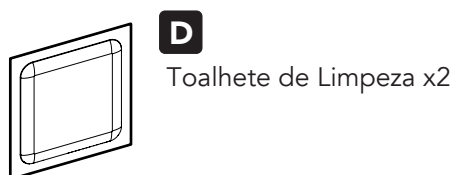

Certifique-se de que as faixas A e B estão planas antes da instalação.

Para Aplanar:

Desenrole ambas as faixas, depois enrole de novo na direção oposta e coloque de volta na embalagem. Deixe durante pelo menos 30 minutos.

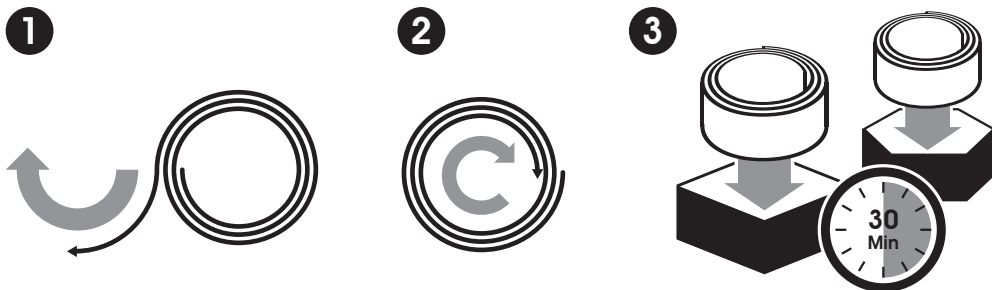

DICA

Para evitar fazer dobras, primeiro enrole um laço mais amplo, depois aperte para caber dentro da caixa.



Para que o adesivo seja eficaz, certifique-se de que a parede está limpa e seca.

Limpe a parede minuciosamente utilizando os toalhetes **D** fornecidos.

Certifique-se de que a parede está seca antes da instalação.

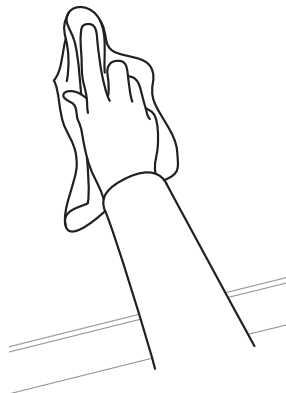
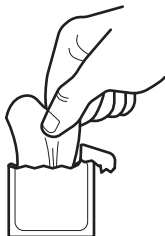

1 Meça e corte as faixas **A** e **B** para encaixarem no espaço exigido.

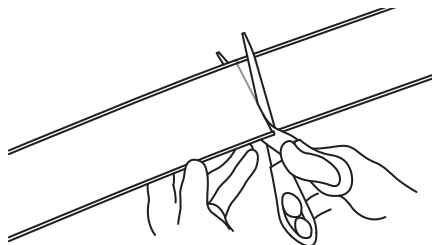
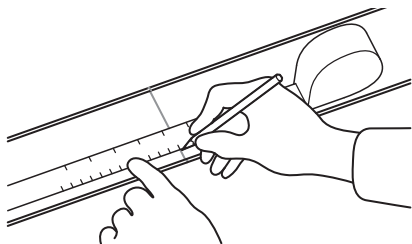

Remova o papel de suporte das faixas adesivas na Faixa de Parede **A**.

Utilize um nível como um guia e aplique a Faixa de Parede **A** à parede.

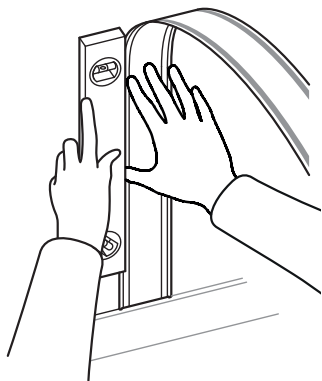

Utilize um pano limpo e seco para pressionar e esfregar firmemente ao longo dos canais.

Isto ajudará a criar uma ligação forte com a sua parede.

Repita após 5 minutos.

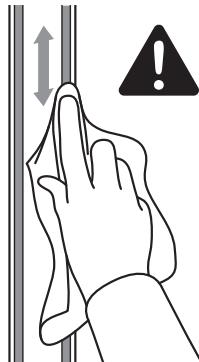

2

Com os cabos no lugar, prenda um lado da Faixa de Cobertura **B** na Faixa de Parede **A**.

Trabalhando a partir de cima, aperte a Faixa de Cobertura **B** até que o outro lado fique preso no lugar, depois deslize o polegar para baixo até que o resto da Faixa de Cobertura **B** fique preso no lugar.

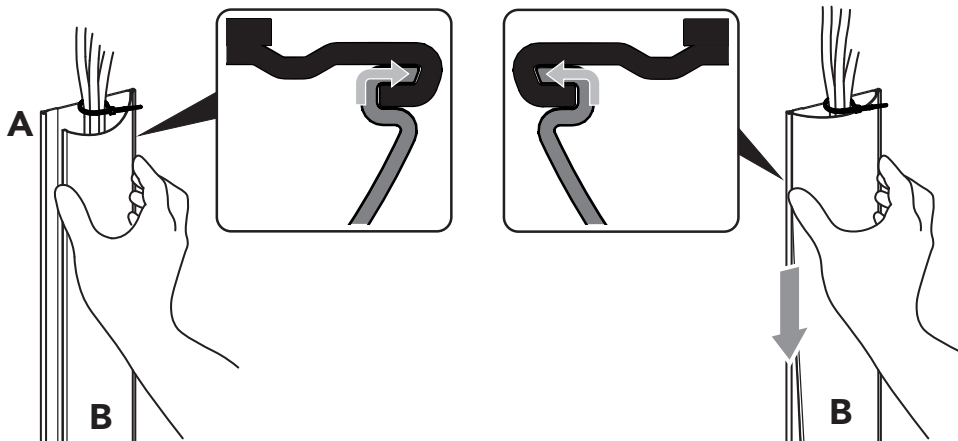

DICA

Para facilitar a manutenção dos cabos enquanto fixa a Faixa de Cobertura **B**, pode enrolar a fita adesiva, ou utilizar uma braçadeira, à volta dos seus cabos na parte superior e inferior.

3

Segure a faixa da gestão de cabos em cima e em baixo utilizando os grampos **C**.

Empurre o Grampo **C** sobre a faixa de gestão de cabos. Certifique-se de que fica preso no lugar por detrás da faixa de parede.

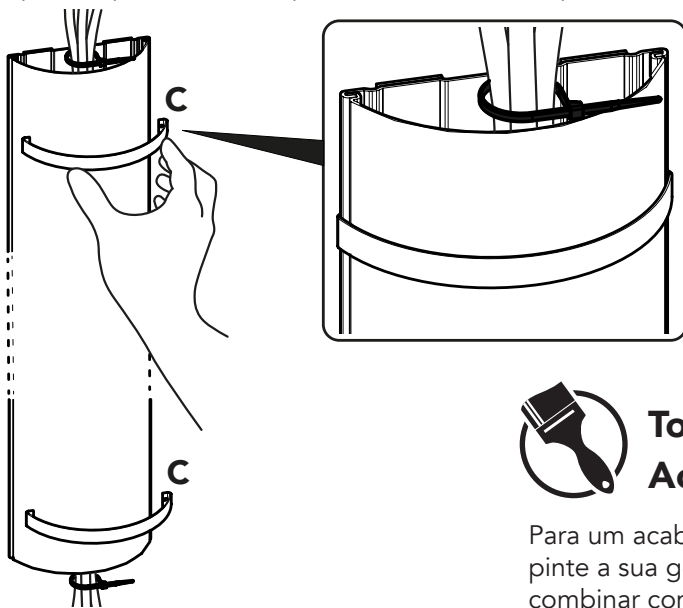

Toque de Acabamento

Para um acabamento profissional, pinte a sua gestão de cabos para combinar com a sua decoração.