

jl.avfgroup.com

469017 rev05

JML8651

**Please read these instructions thoroughly
before installation.**

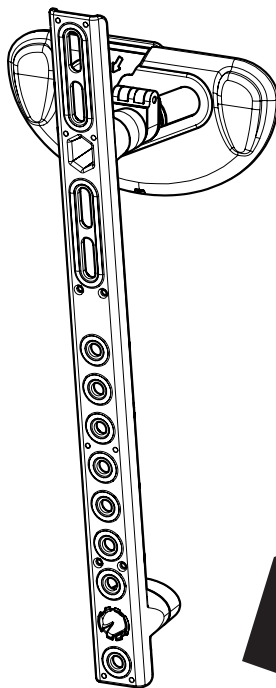
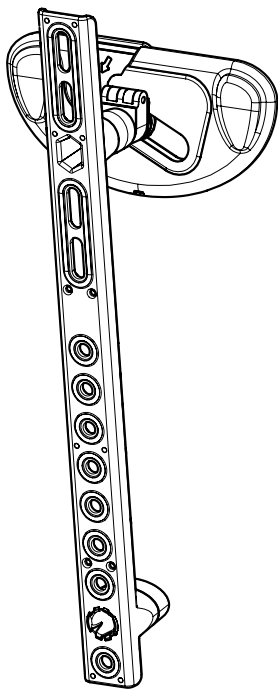

**55kg
120lb**

If you have any questions or need
spare parts don't worry, we're happy to help.

CUSTOMER SERVICES HELPLINE NUMBER: 0333 320 0463

AVF Group Ltd. Hortonwood 30, Telford, Shropshire, TF1 7YE, England

Assembly Overview

Fit Screen Hangers or Tilt Brackets to TV

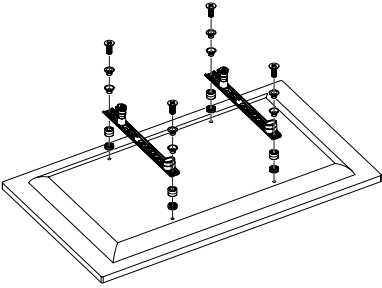

Your TV can be mounted either flat to wall, or with 4° or 8° of fixed downward tilt. Decide how you want to mount your TV and follow the corresponding steps.

This product comes with screws to fit a huge range of TVs. You will have a lot of screws left over. We recommend keeping them in a safe place in case you change your TV in the future.

Fitting the Wall Brackets

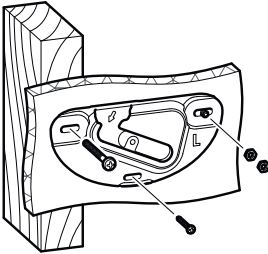

The JML8651 is suitable for attaching to plasterboard, wood and metal stud, brick, dot and dab, concrete, or any combination of these wall types. Establish which wall type you are mounting to and follow the corresponding steps.

This product comes with fixings for all the wall types mentioned above. You will have lots of wall fixings left over. We recommend keeping them in a safe place in case you want to move your TV to a different wall type in future.

Hanging the TV

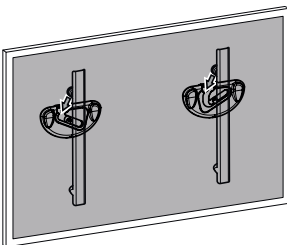

The procedure for hanging the TV is exactly the same for Flat to Wall or either Tilt option.

Index

1 Measure the TV fixing holes Width and Height

2 Prepare Tilt Brackets - Skip this step if mounting Flat to Wall

3a Fit Screen Hangers to TV - Flat to Wall Option

3b Fit Tilt Brackets to TV - 4° or 8° Fixed Tilt Option

4 Marking Wall for Drill Points

5 Fitting the Wall Brackets

6 Hanging the TV

Retain all packaging in case the product needs to be returned.

Contents may vary from photography / illustrations.

You will not need all these parts, so expect there to be some left over depending upon the specification of your TV.

This product is intended for indoor use only. Use of this product outdoors could lead to failure and personal injury.

It is the responsibility of the installer to ensure that the mounting wall is of a suitable standard and void of any services (eg gas, electricity, water etc).

AVF accept no responsibility for any damage or loss caused by installing this product in a substandard wall.

You Will Need

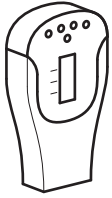

Stud Finder

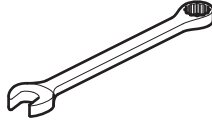
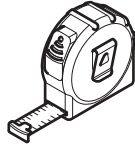

Ø5.5mm (7/32") Masonry



Ø10mm (25/64") Masonry



Ø3.5mm (9/64") Metal



Ø3mm (1/8") Wood

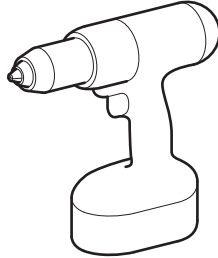
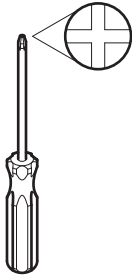
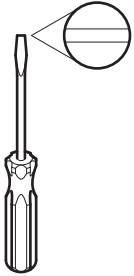

Boxed Parts

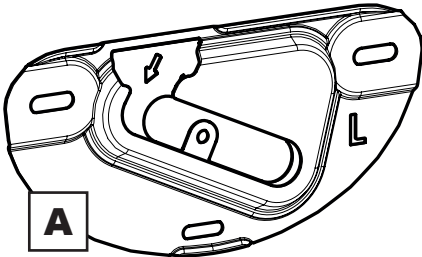

A

B

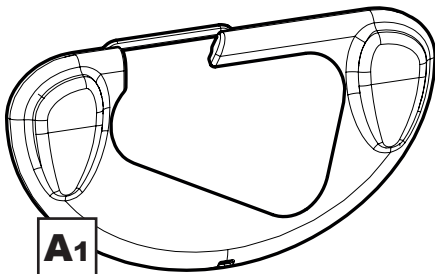

A1

B1

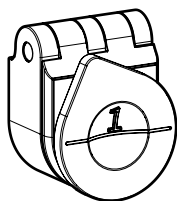

C1 x1

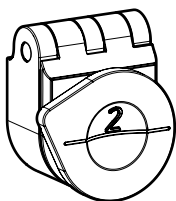

C2 x1



D x2

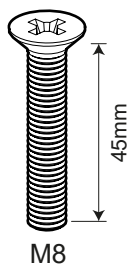

M8

V1 x2



M8

V2 x2

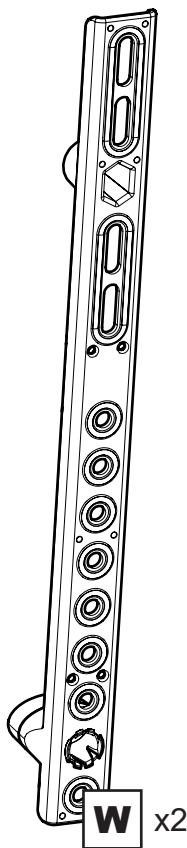

W x2



X x2

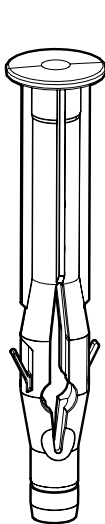

I x4

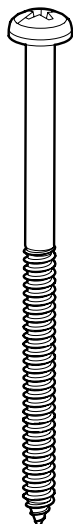

K x4

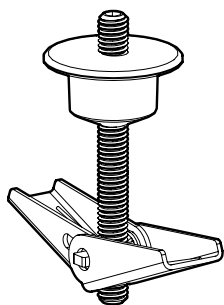

H x4

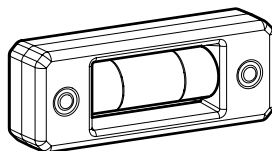

T

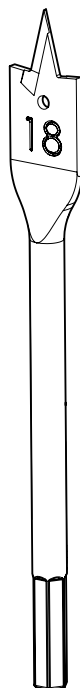

R



J x8

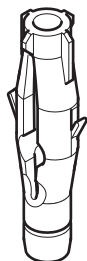

M x4

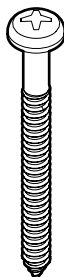

N x4

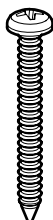

O x2



P x2



Q x2



S

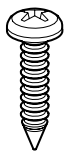

L x2

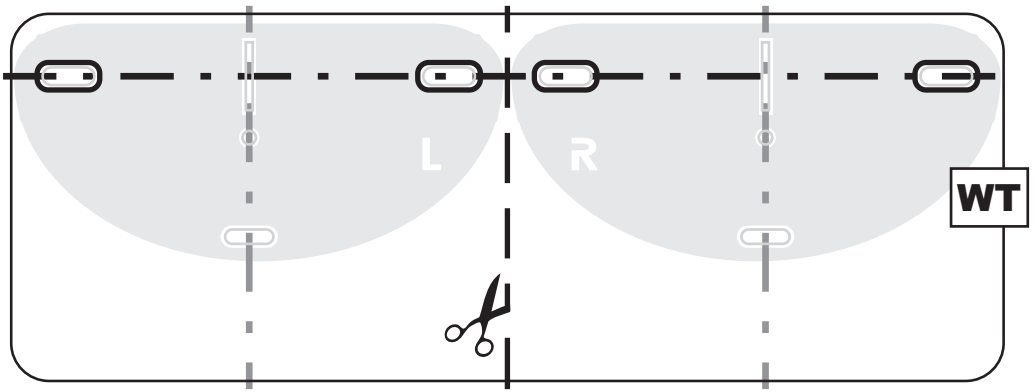

TV Screws, Reducers and Spacers

M4's

M6's

M8's

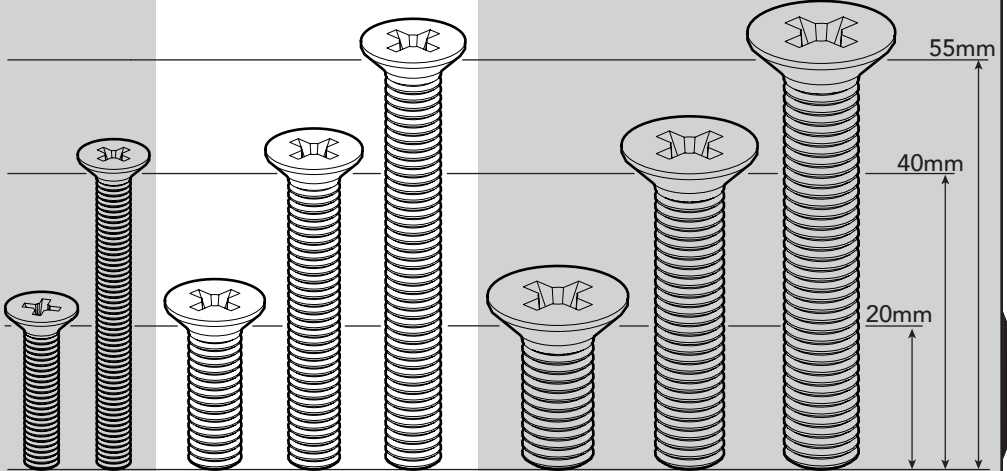

G1

G2

G3

G4

G5

G6

G7

G8

x4

x4

x4

x4

x4

x4

x4

x4



F1

x4



F2

x4



E1

x12



E2

x4



E3

x4

1 Measure the TV fixing holes Width and Height

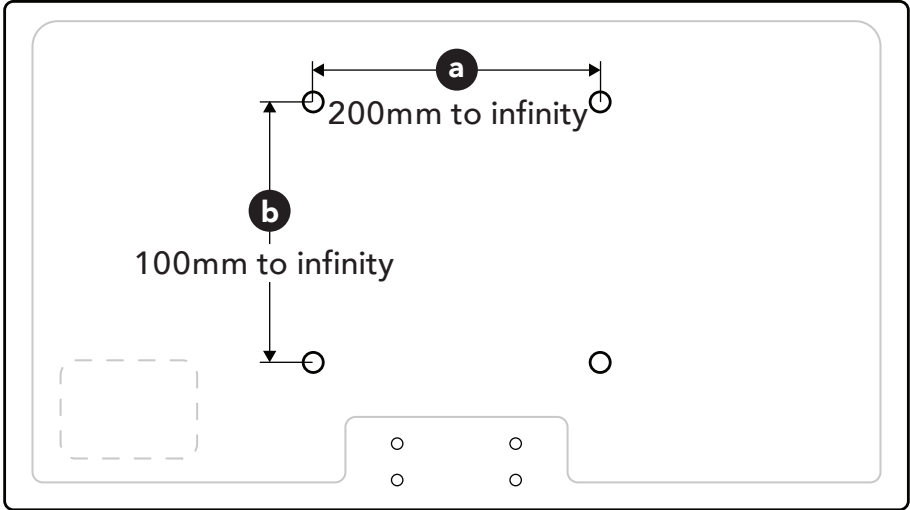

If width **a** is less than 200mm or height **b** less than 100mm
STOP installation now and contact the customer helpline.

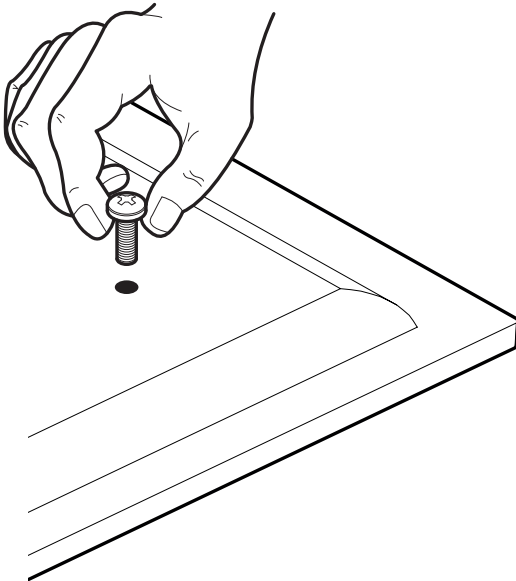

Determine which diameter TV Screws
fit your TV and put them to one side.

M4, M6 or M8

We will select the correct length later.

2 Prepare Tilt Brackets - Skip this step if mounting Flat to Wall



You can choose between two different fixed tilt positions, either 8° or 4°.

8° Tilt



Ensure a flush fit between tilt bracket **W** and spacer **X** by lining up the notch and pip correctly.

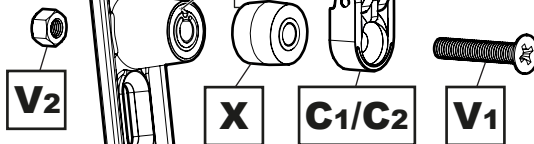
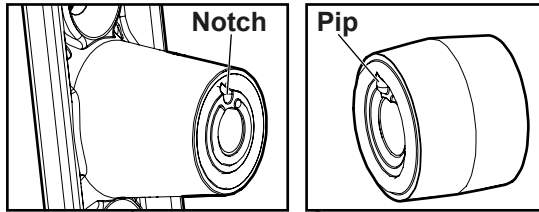

Use your fingertip to hold nut **V2** steady while you tighten screw **V1**.

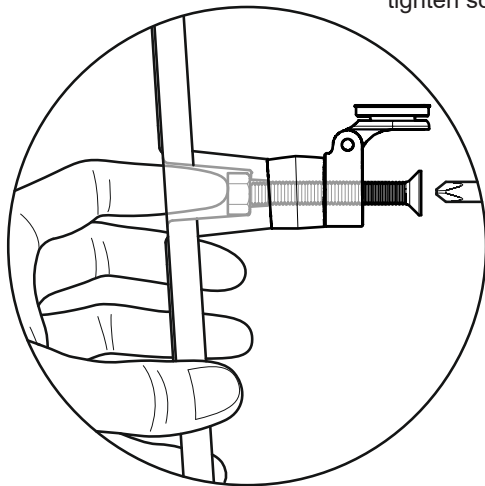

W

x2



Make sure Screen Hangers **C1** and **C2** are fully closed after assembly is complete.

4° Tilt

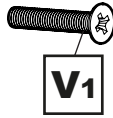
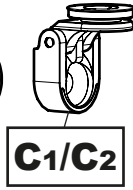

Use your fingertip to hold nut **V2** steady while you tighten screw **V1**.

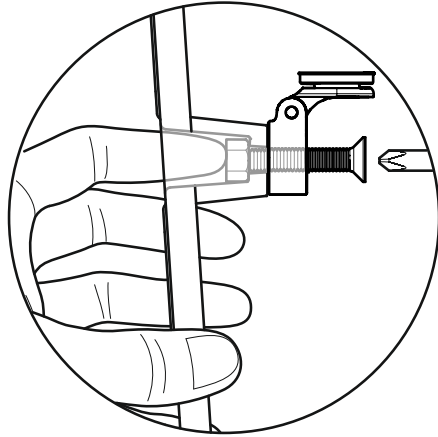

Make sure Screen Hangers **C1** and **C2** are fully closed after assembly is complete.

x2

Check to see if your TV will clash with the wall. If a clash occurs it will be necessary to add **E1** spacers to prevent this. If a clash occurs even after using all the **E1** spacers you will have to change the tilt. Please see below for an example.

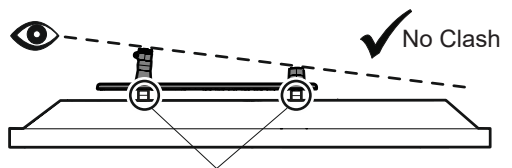
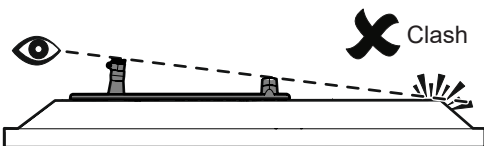

Spacers **E1** are used between tilt bracket **W** and TV to prevent clash with wall.

3a Fit Screen Hangers to TV - Flat to Wall Option

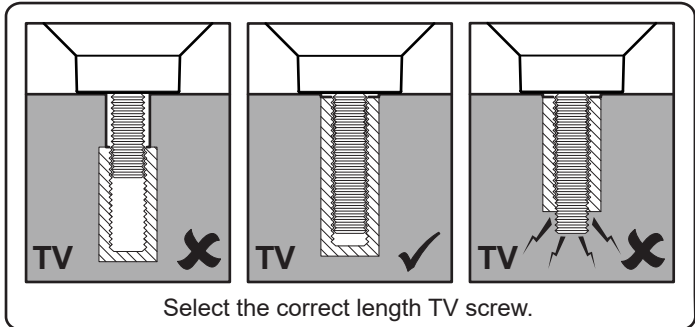
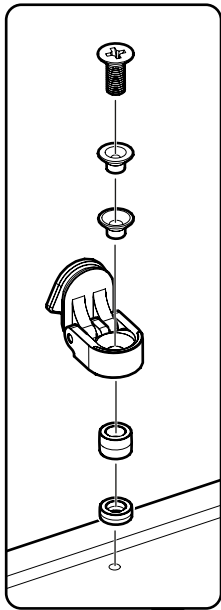

Select the correct length TV screw.

G1 - G8

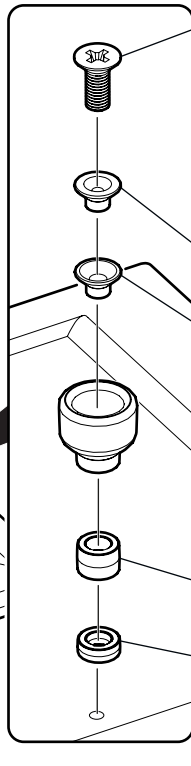
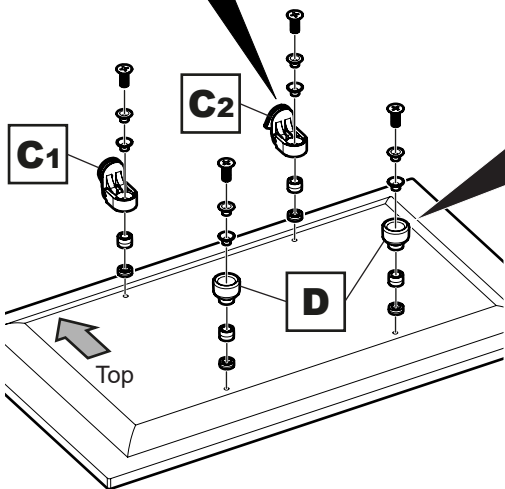

	G1 - G2	G3 - G5	G6 - G8
F1	✓	✗	✗
F2	✗	✓	✗

Do you need F1 or F2?

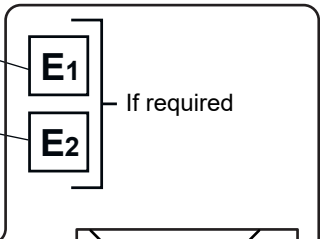

You may need to use Spacers **E1** or **E2** if the screws are too long or the back of your TV is not flat.

You can also use longer screws and the spacers to help avoid cabling or plug sockets on your wall.

3b Fit Tilt Brackets to TV - 4° or 8° Fixed Tilt Option

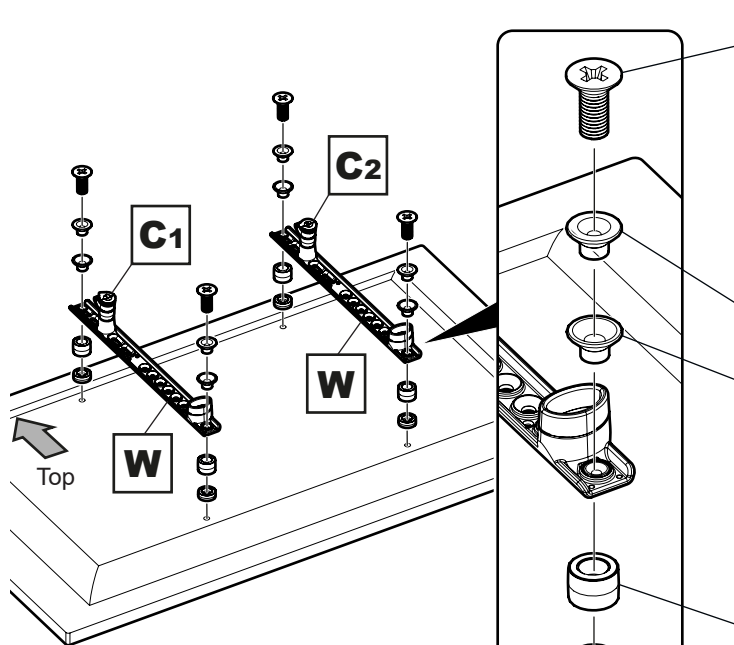
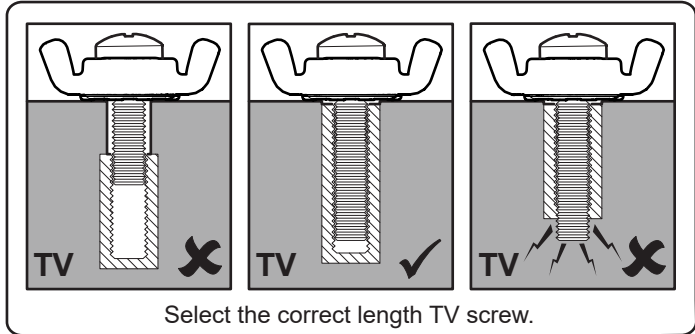

G1 - G8

	G1 - G2	G3 - G5	G6 - G8
F1	✓	X	X
F2	X	✓	X

Do you need F1 or F2?

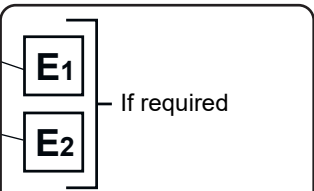

You may need to use Spacers **E1** or **E2** if the screws are too long or the back of your TV is not flat.

You can also use longer screws and the spacers to help avoid cabling or plug sockets on your wall.

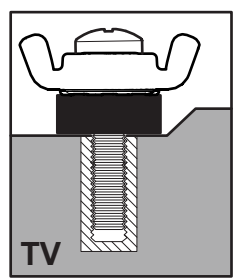

4 Marking Wall for Drill Points



For this step you will need your Wall Marking Template **WT**.

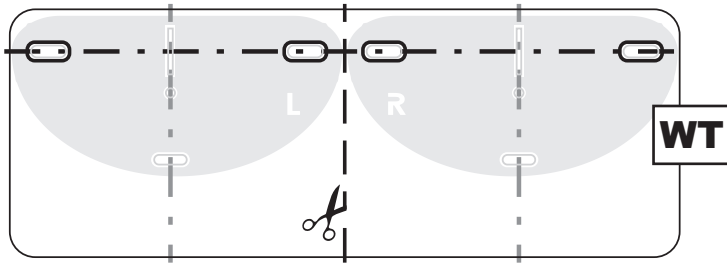

Use the Height Calculator app to achieve your desired TV height. Follow the link to the app shown on your Wall Marking Template.



Before marking the wall, determine the wall type that you have (i.e. Solid Wall/ Dot & Dab/Plasterboard/Wood Stud/Metal Stud). Ensure the drilling area is free from mains services (Gas/Electric/Water).



The Height Calculator app will give you the correct height to mark a horizontal line on your wall.



Mark a vertical line on the wall where you want the centre of your TV to be.

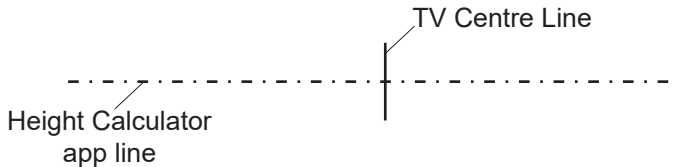

Measure the distance between the top two fixing holes on the back of your TV. Halve this number and mark a vertical line, this distance, either side of the TV Centre line on your wall (e.g. if the fixing holes are 400mm apart, measure 200mm either side of the TV Centre line).

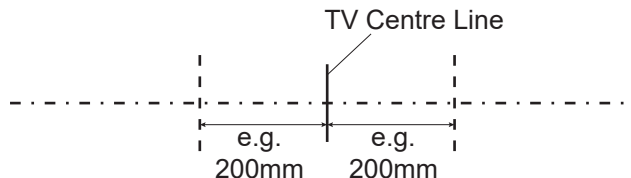
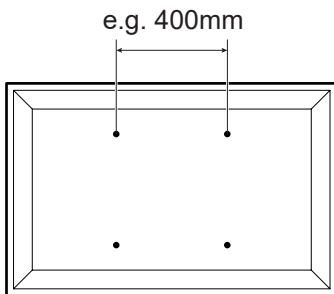

iv

Cut your Wall Marking Template along the dotted centre line. Place each half on the wall so the lines on the template match the lines marked on your wall. Mark the drill points as shown.

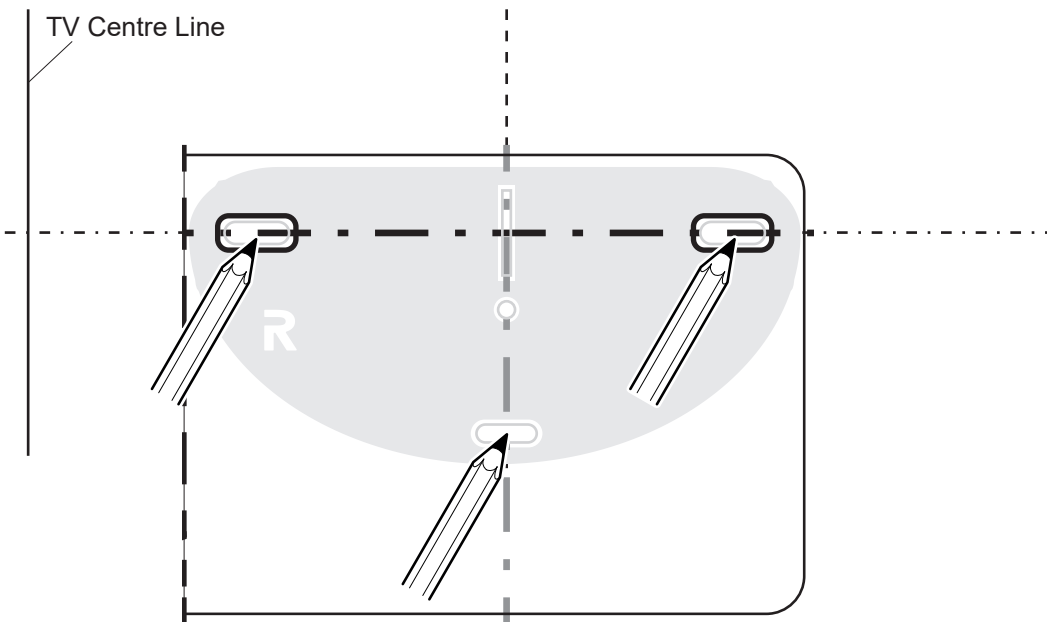
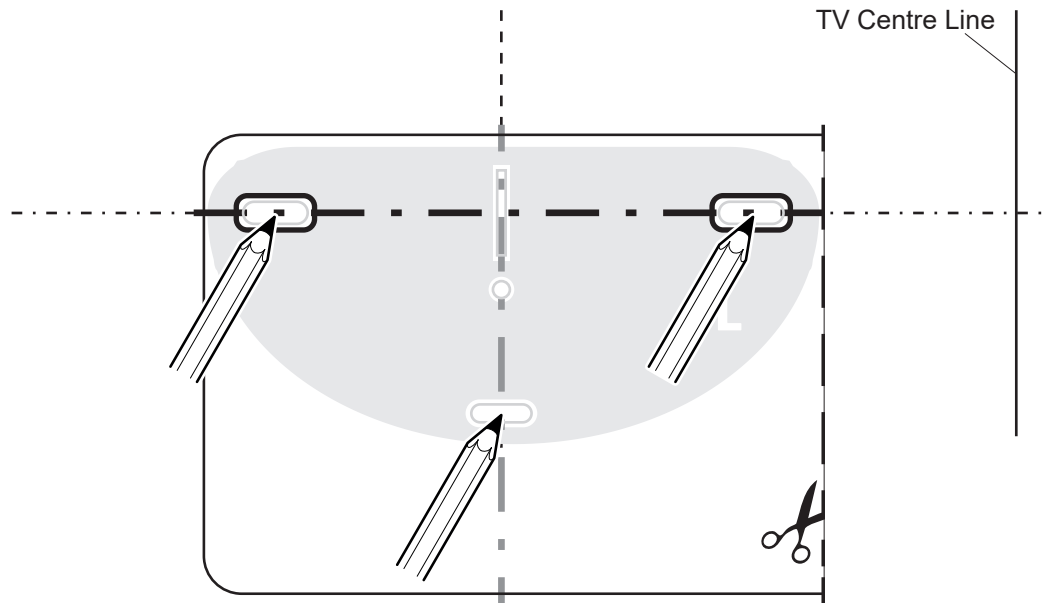

i

Before you drill make sure you are happy with the position and ensure all markings are correct and level.

5 Fitting the Wall Brackets

Remove the Wall Bracket Covers.

Wall Bracket Covers **A1** and **B1** are removed in the same way.

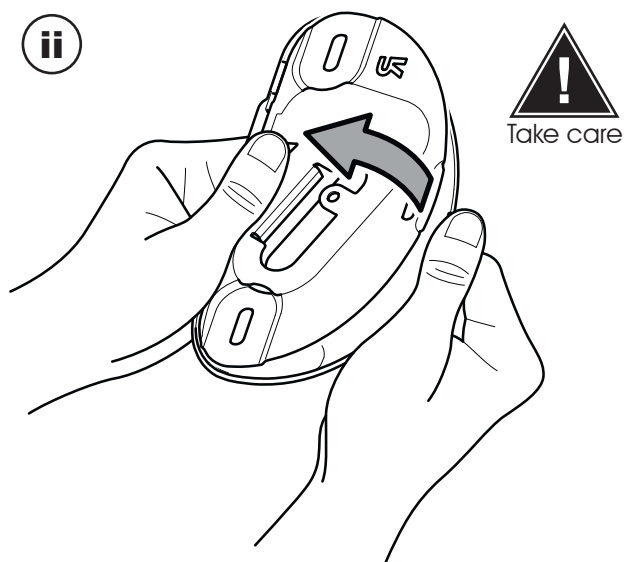
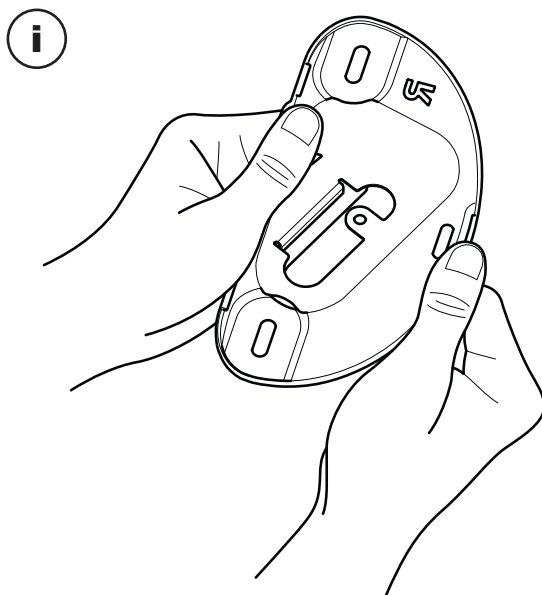



This product is designed to be fitted to many different types of wall.

Identify your wall type and follow the relevant instruction. Make sure you use the correct fixings for your wall.

Solid Wall

i

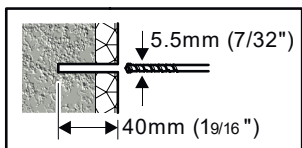
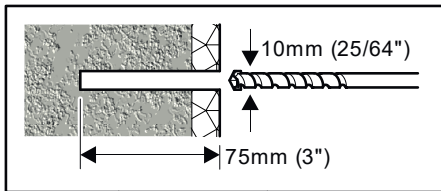

Remove Dust from Holes.

ii

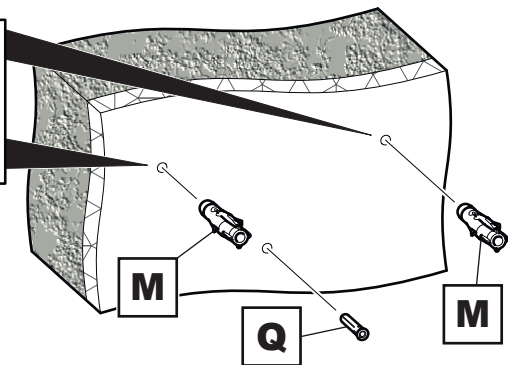
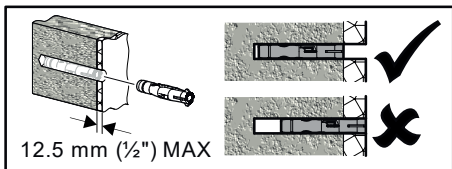

iii



Lubricate screw thread with soap.



DO NOT overtighten screws.
Tighten screws by hand only

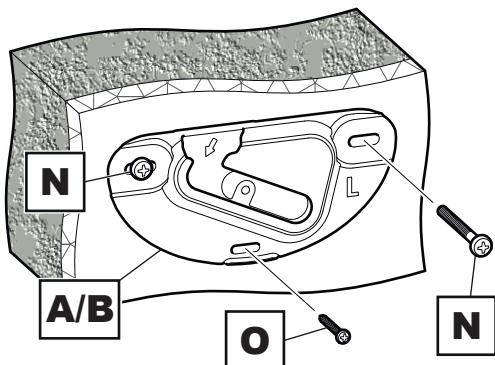

Dot and Dab

i

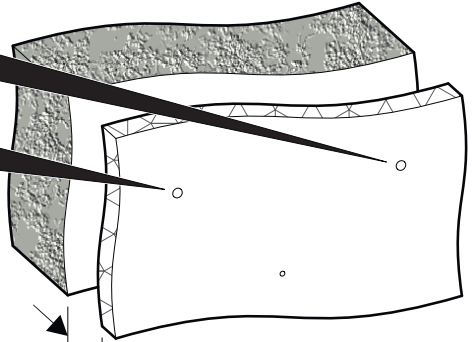
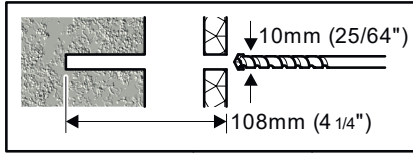

Remove Dust from Holes.

* 40mm (1 9/16")
MAX gap

* If gap is above 40mm (1 9/16") use
plasterboard fixing method

ii



If you have trouble fitting **P**
you can drill a 3mm pilot hole.

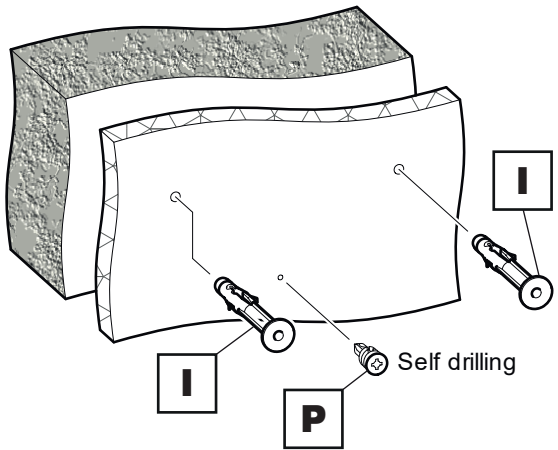

iii



Lubricate screw thread
with soap.



DO NOT overtighten screws.
Tighten screws by hand only

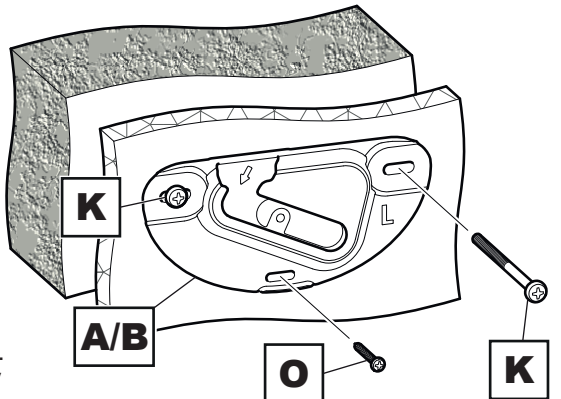

Plasterboard

i

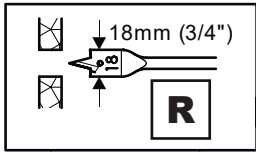

Remove Dust from Holes.

* 40mm (1 9/16")
MIN gap

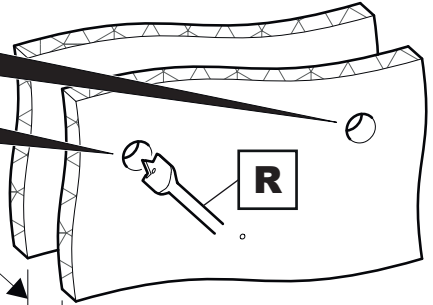

ii

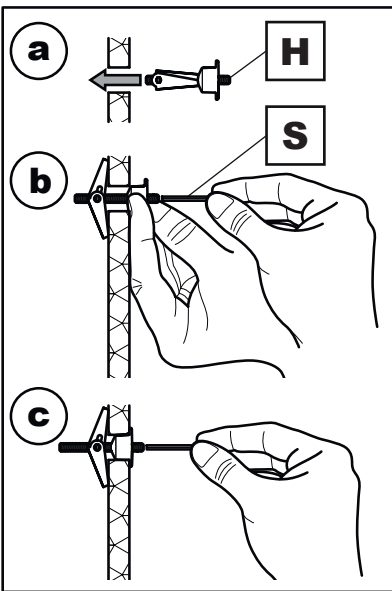

If you have trouble fitting **P** you can drill a 3mm pilot hole.

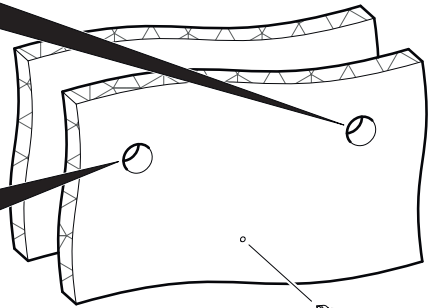

Self drilling
P

iii



Lubricate screw thread with soap.



DO NOT overtighten screws.
Tighten screws by hand only

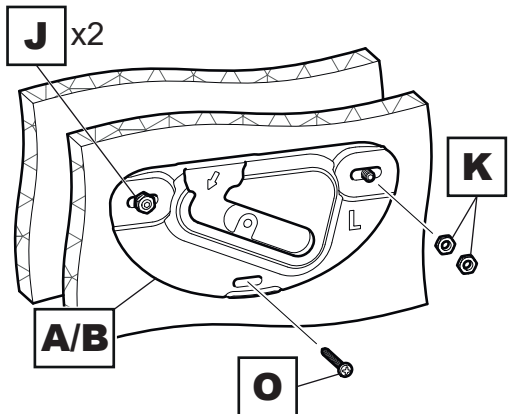

Wood Stud

i

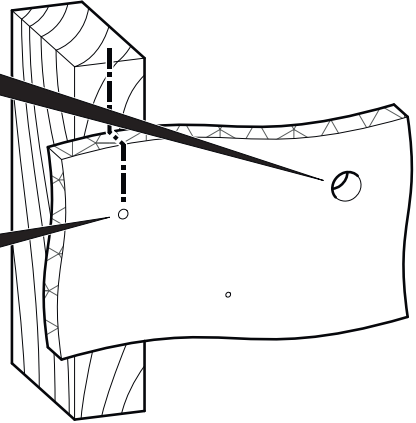
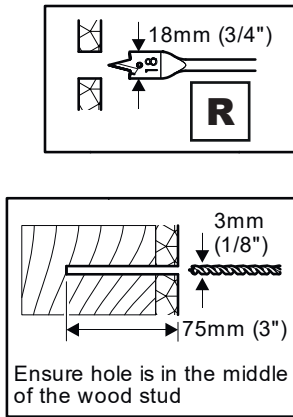

ii

Only one fixing will be in the wood stud. The other fixings will be in plasterboard (see Plasterboard installation instruction).

i

If you have trouble fitting **P** you can drill a 3mm pilot hole.

i

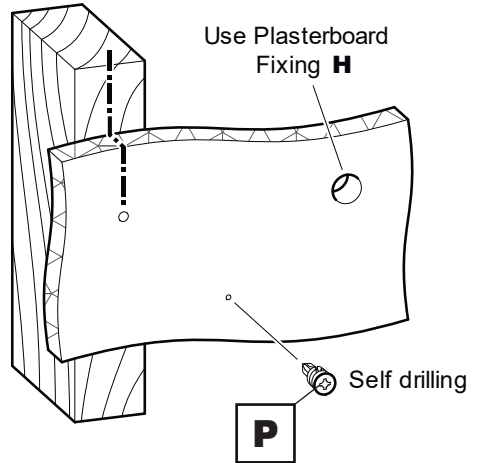

iii



Lubricate screw thread with soap.



DO NOT overtighten screws. Tighten screws by hand only

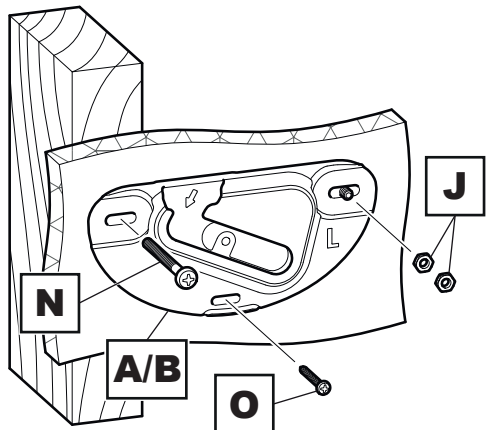

Metal Stud

i

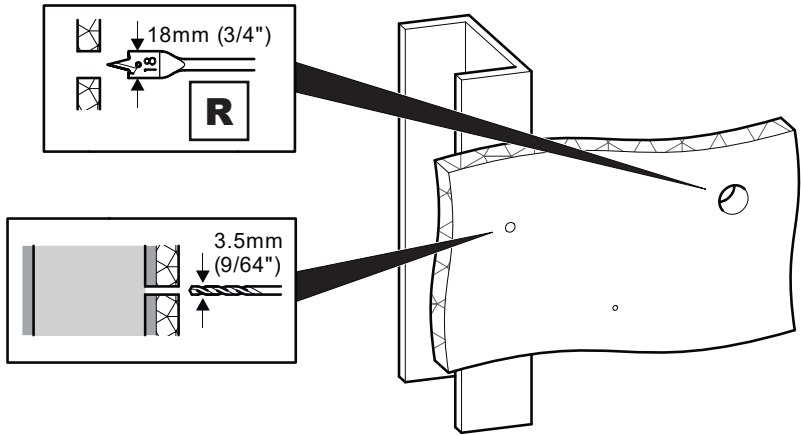

ii

Only one fixing will be in the metal stud. The other fixings will be in plasterboard (see Plasterboard installation instruction).

i

If you have trouble fitting **P** you can drill a 3mm pilot hole.

i

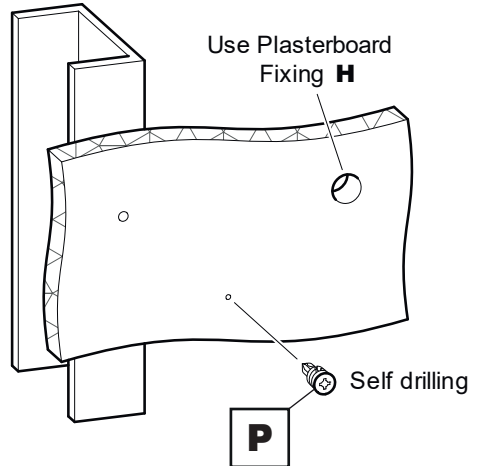

iii



DO NOT overtighten screws.
Tighten screws by hand only

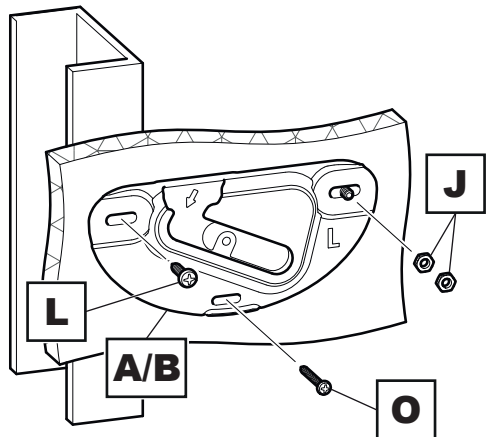

Replace the Wall Bracket Covers.

On the Wall Bracket Covers **A1** and **B1** there are three retaining tabs. These locate onto three retaining lips on the Wall Brackets **A** and **B** and lock the Wall Bracket Covers in position.

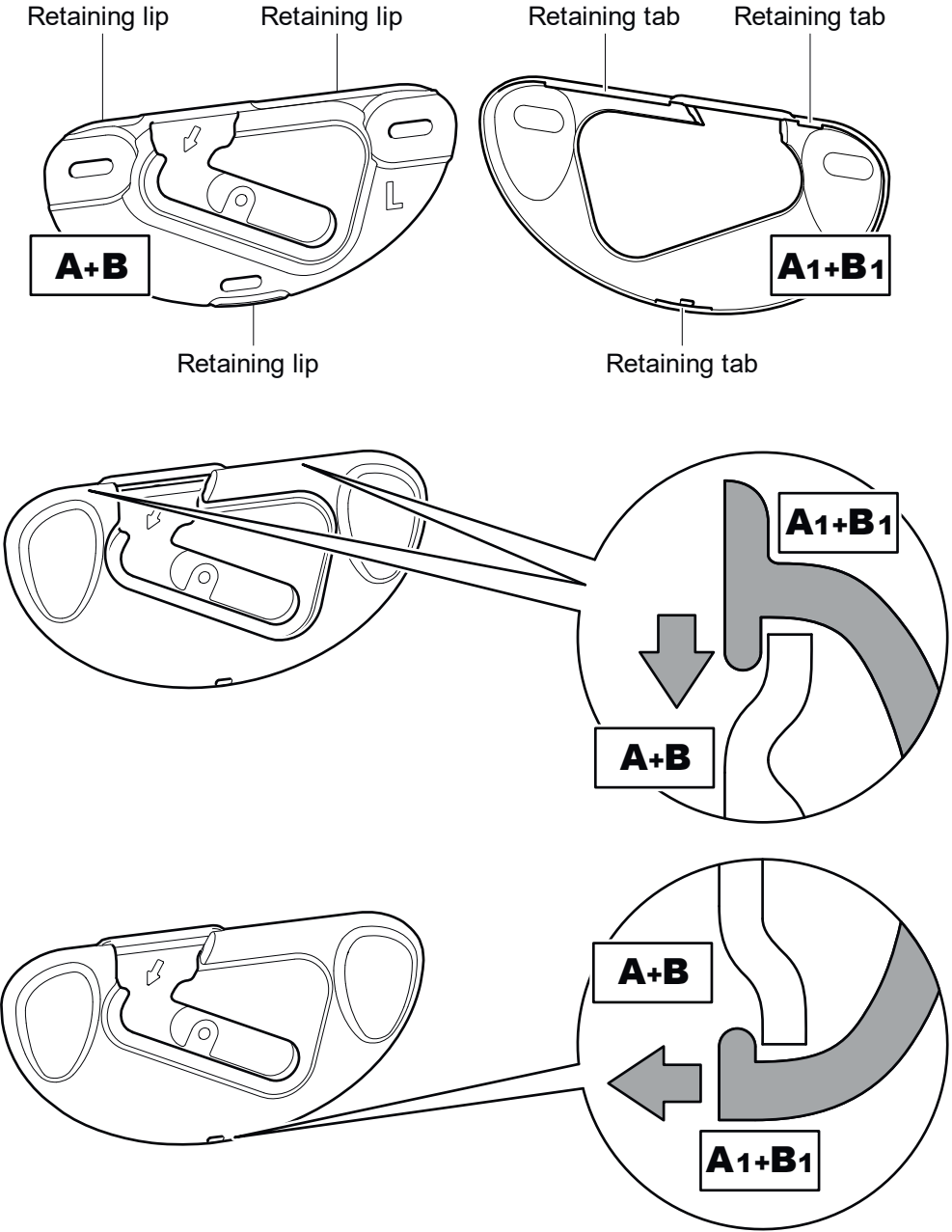

6 Hanging the TV

i The procedure for hanging the TV is exactly the same for Flat to Wall or either Tilt option.

i Make sure Screen Hangers **C1** and **C2** are fully closed before hanging the TV.

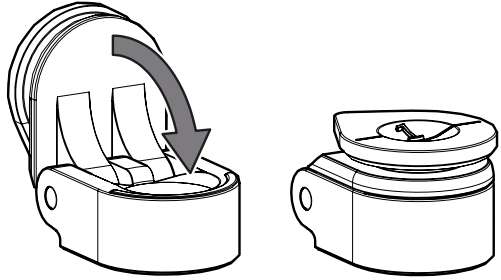

Line must be horizontal before attempting to hang the TV.

Check Hangers **C1** and **C2** are on the correct side before hanging the TV.

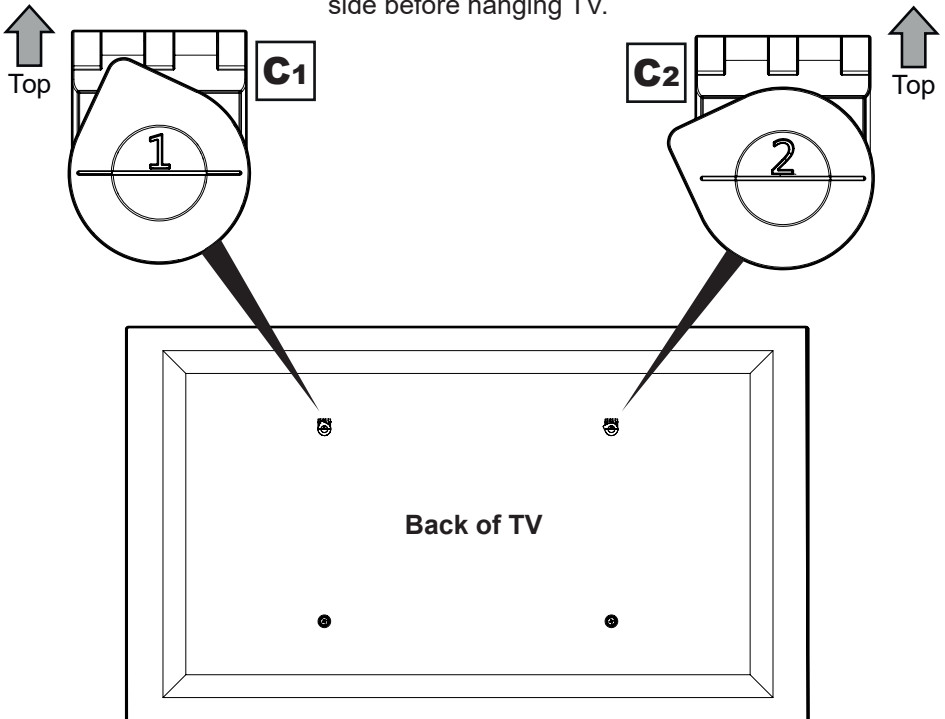



Present Hangers **C1** and **C2** (on the back of the TV) to the opening on Brackets **A** and **B**. Slide down and across into place. Ensure both Hangers are fully engaged. If cables from the TV prevent the TV resting against the wall then an alternative Hanger configuration will be required (see Section 3). TV must be parallel to wall.



View “through” TV from the front.

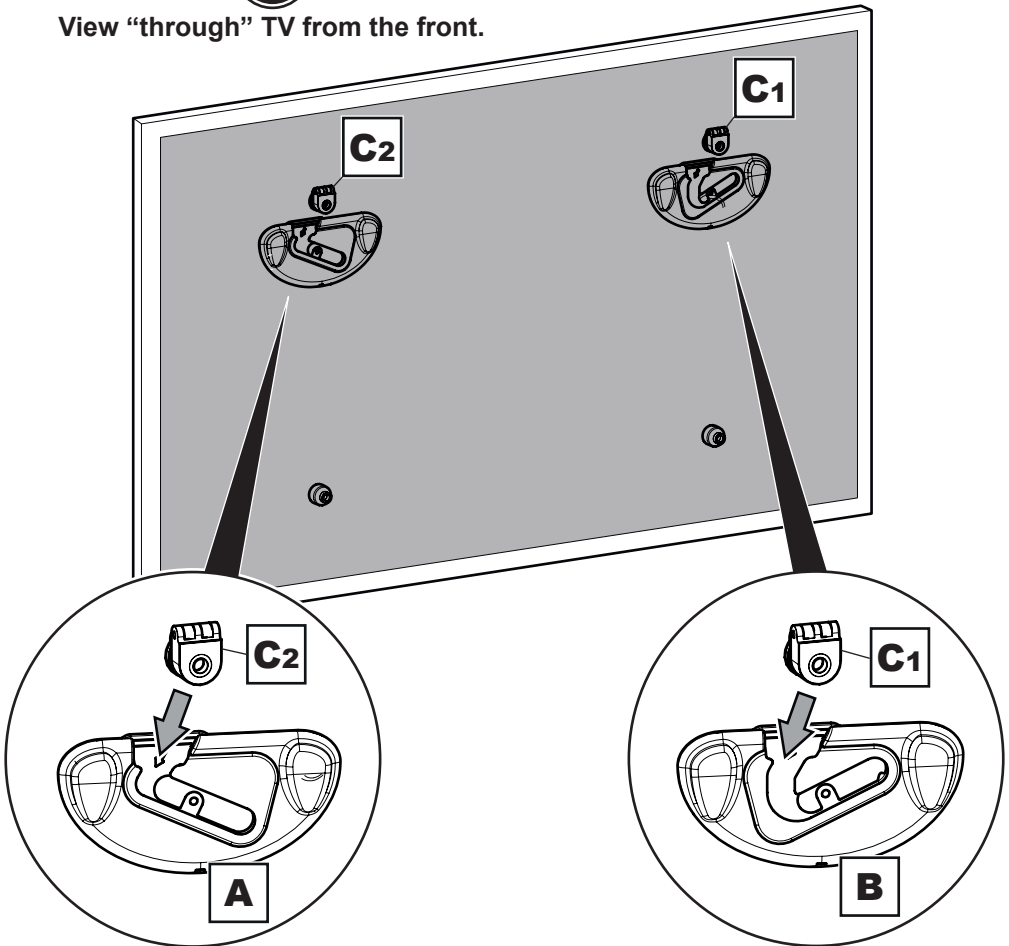

i

i

View "through" TV from the front.

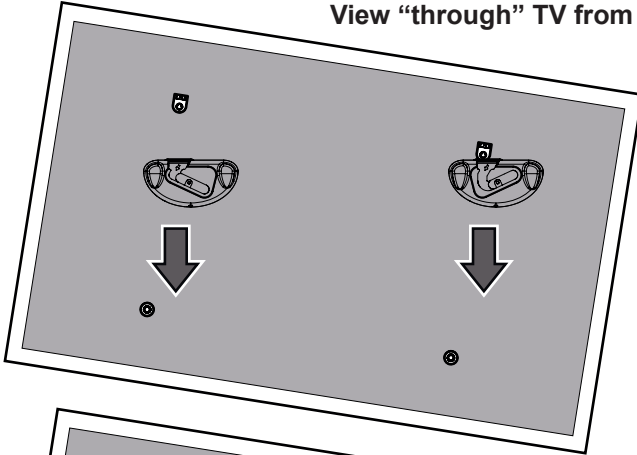

ii

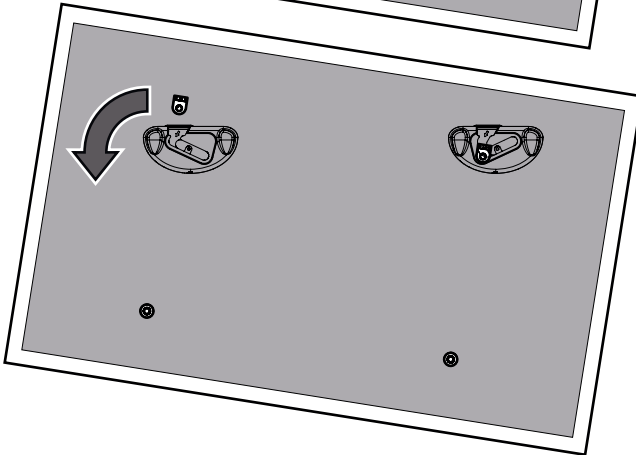

iii

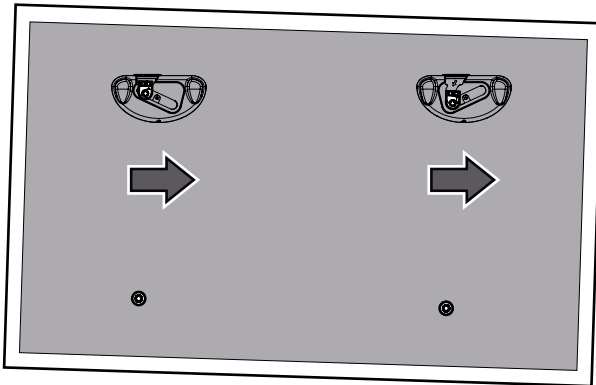

DO NOT release TV until it is secure and level.

i

Removing the TV

To remove the TV reverse the movements as shown above