

jl.avfgroup.com

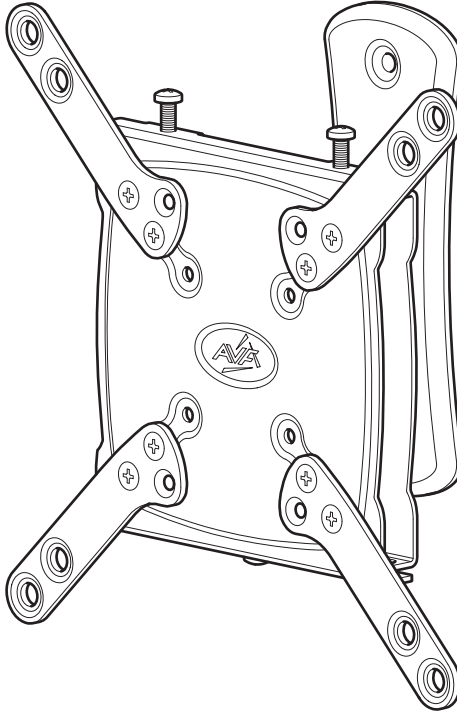

466523 rev00 ###

JGL202



20kg
44lbs

STOP

Read through **ALL** instructions before commencing installation.

If you have any questions about this product or issues with installation, contact the customer services help line before returning this product to the store.

CUSTOMER SERVICES HELP LINE NUMBER: 0333 320 0463

AVF Group Ltd. Hortonwood 30, Telford, Shropshire, TF1 7YE, England

Assembly Overview

Fit the TV Mounting Plate

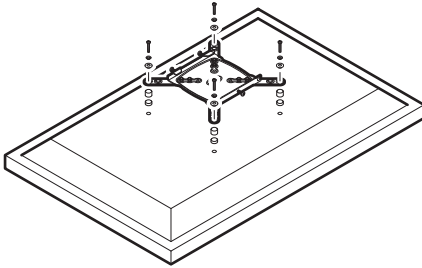

Fit the Wall Bracket

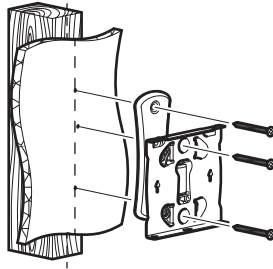

Connect the TV

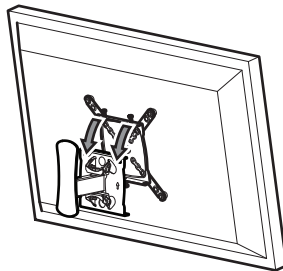

Suitable Wall Types

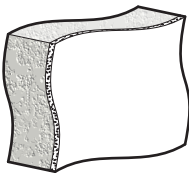

Solid Wall

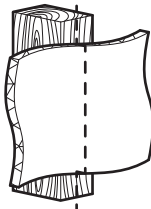

Wood Stud

Tools Recommended



Stud Finder



Ø10mm (25/64")
Masonry

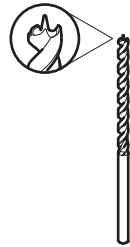

Ø3mm (1/8")
Wood

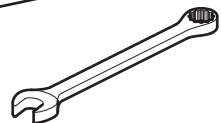
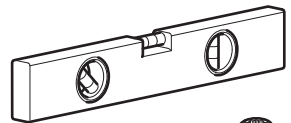
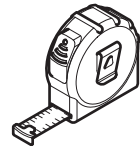
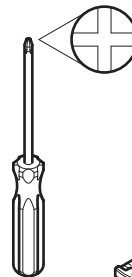
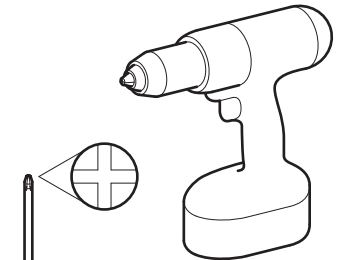

Index

1 Measure the TV fixing holes Width and Height

2 Preparing the TV Mounting Plate

3 Fitting the TV Mounting Plate

4 Fitting the Wall Bracket

5 Connecting the TV

Retain all packaging in case the bracket needs to be returned.

Contents may vary from photography/ Illustrations.

You will not need all these parts, so expect there to be some left over depending upon the specification of your TV.

This product is intended for indoor use only. Use of this product outdoors could lead to failure and personal injury.

It is the responsibility of the installer to ensure that the mounting wall is of a suitable standard and void of any services (eg gas, electricity, water etc).

AVF accept no responsibility for any damage or loss caused by installing this product in a sub standard wall.

Boxed Parts

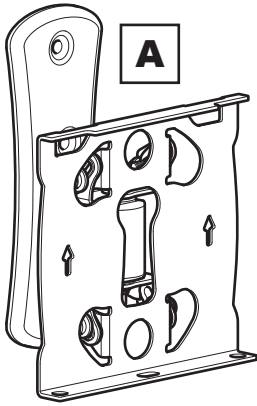

A

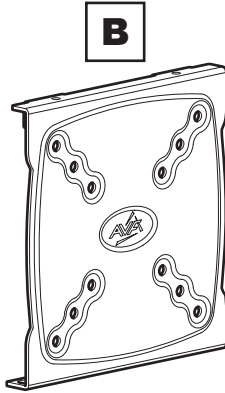

B



C1

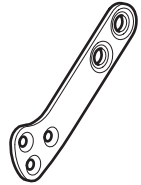

C2

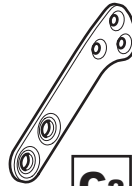

C2



C1

TV Screws, Reducers and Spacers



G1 x4



G2 x4



H1 x4



H2 x4



M4

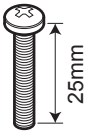

M4



M5

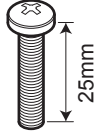

M5

I1 x4

I2 x4

I3 x4

I4 x4



M6

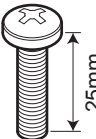

M6

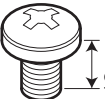

M8

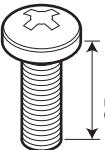

M8

I5 x4

I6 x4

I7 x4

I8 x4



M5

E x3



M5

F1 x8



M5

F2 x8

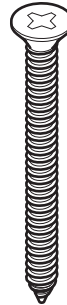

J x3

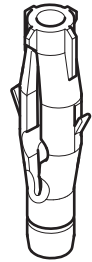

K x3

1 Measure the TV fixing holes Width and Height

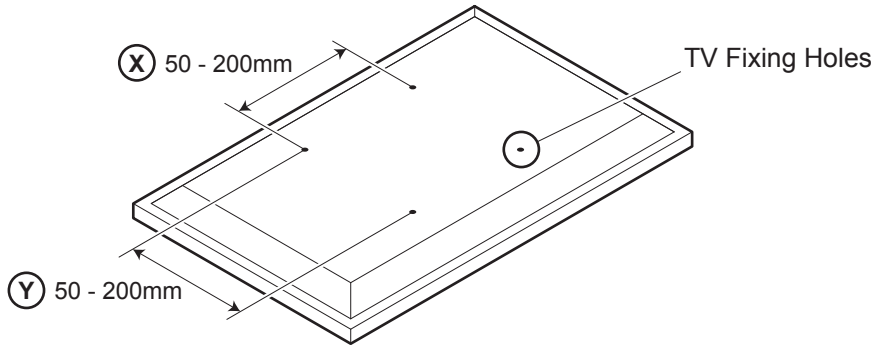

If width (X) is greater than 200mm or height (Y) greater than 200mm STOP installation now and contact the customer help line

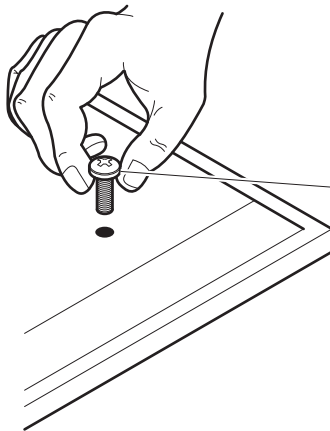

M4 =	I1/I2
M5 =	I3/I4
M6 =	I5/I6
M8 =	I7/I8

You are provided with 4 diameters of TV fixing screws, **M4**, **M5**, **M6** and **M8**. Determine the screw diameter that fits and remember for step 3.

2 Preparing the TV Mounting Plate

Use the option that fits your TV

OPTION 1

- 50mm x 50mm
- 75mm x 75mm
- 100mm x 100mm

OPTION 2

- 100mm x 200mm
- 200mm x 100mm

OPTION 3

- 200mm x 200mm

If in any doubt please call the customer help line

OPTION 1

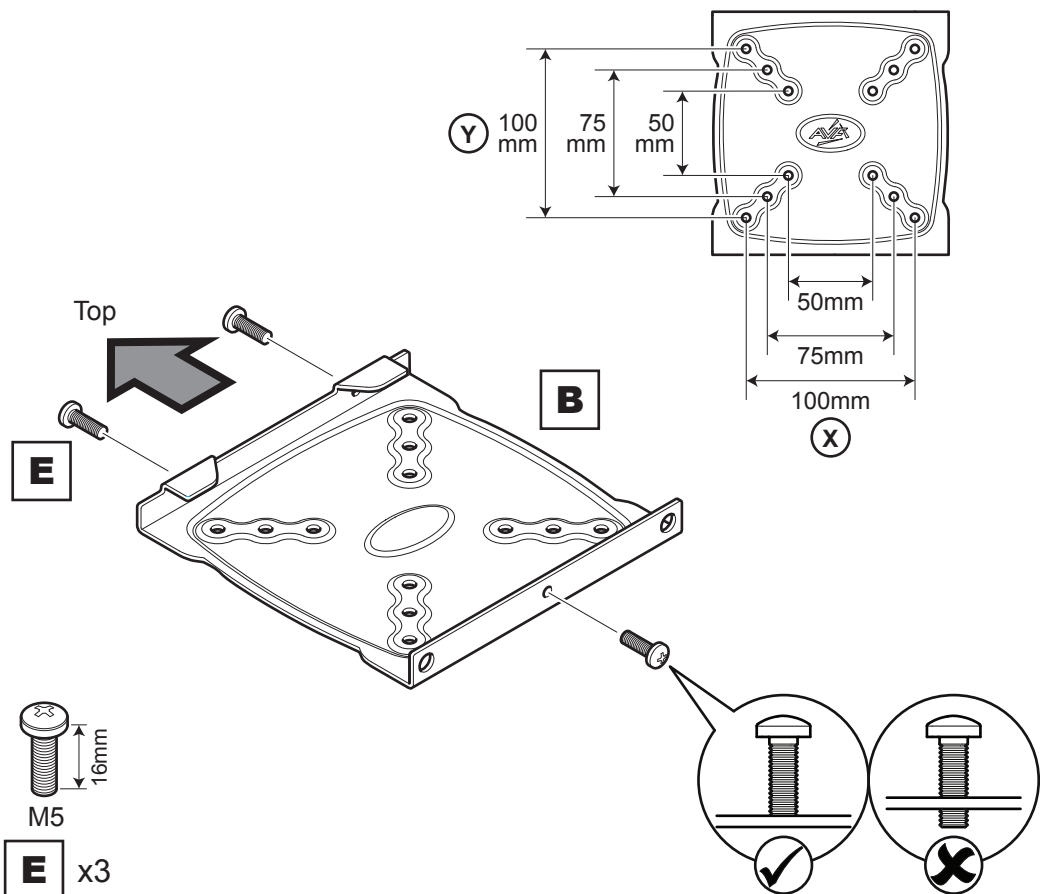

OPTION 2

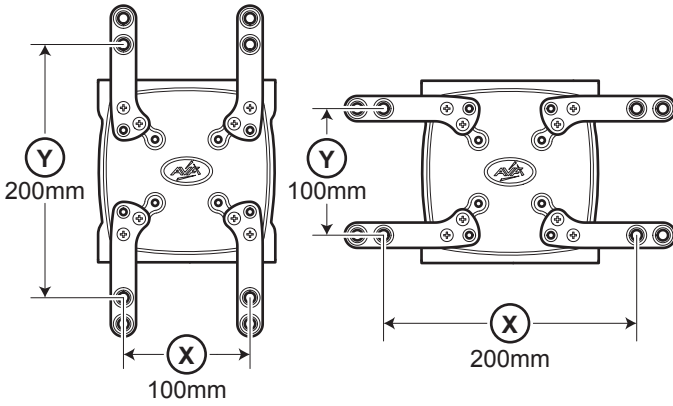

OPTION 3

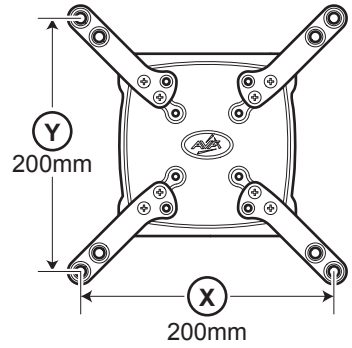

Example shown is 200 x 200 fixings

Top

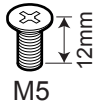
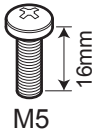
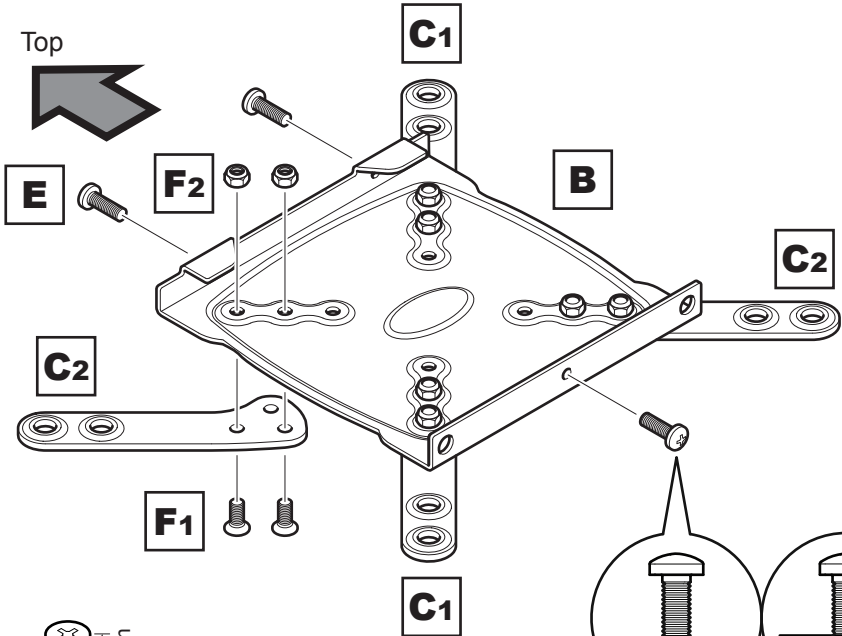

- E** x3
- F1** x8
- F2** x8

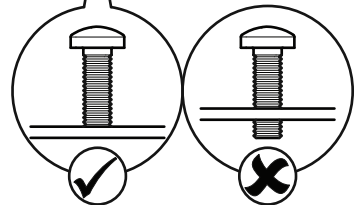

3 Fitting the TV Mounting Plate

No Spacers

For TVs with flat / unobstructed back

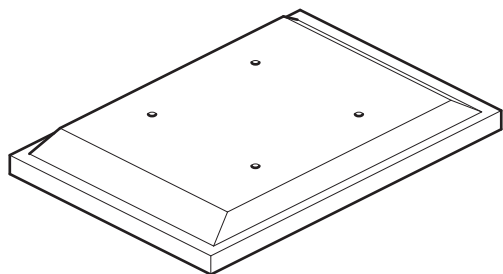

Spacers **H1/H2**

For TVs with irregular / obstructed back

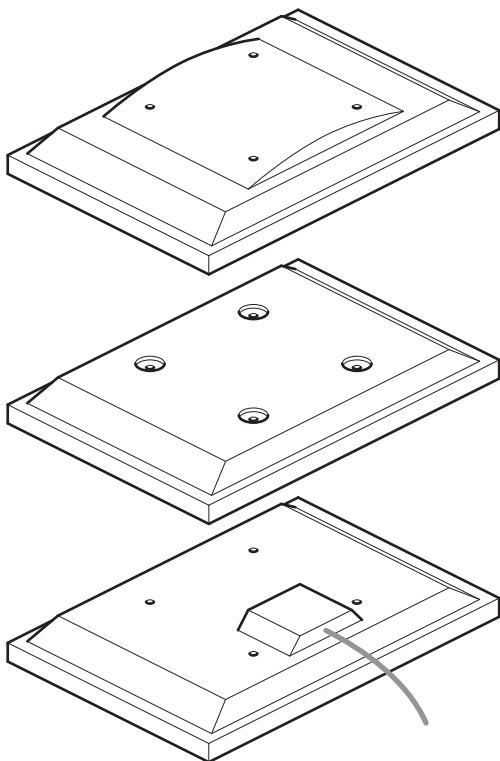

WARNING

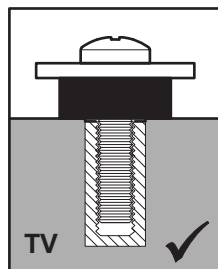
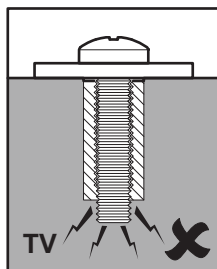
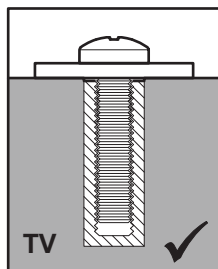
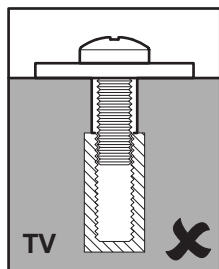

After completing step 3 you will have fittings left over, please keep for future reference

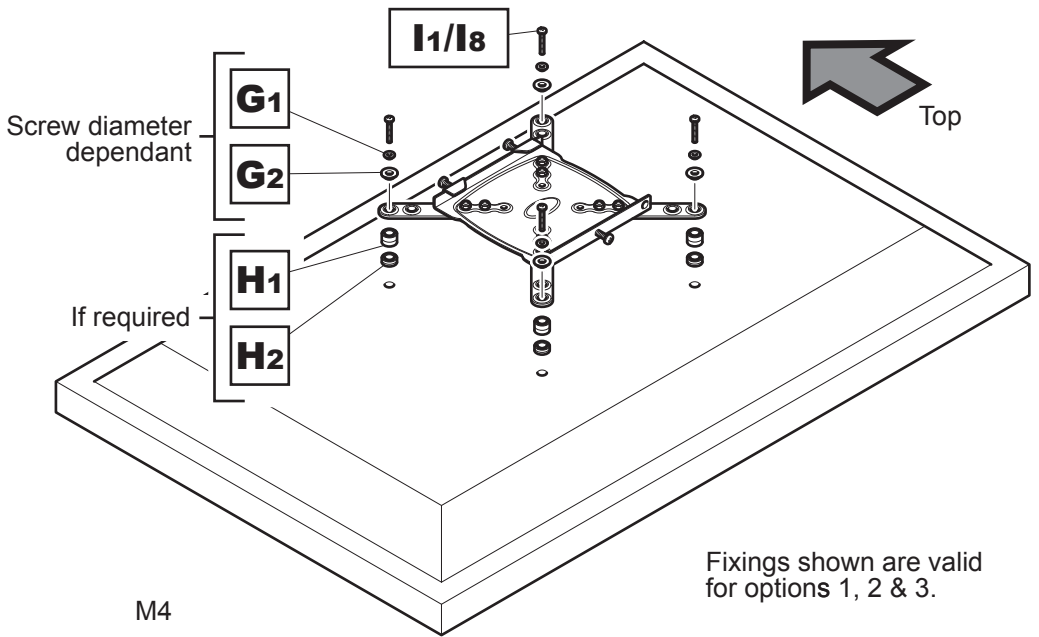

Fixings shown are valid for options 1, 2 & 3.

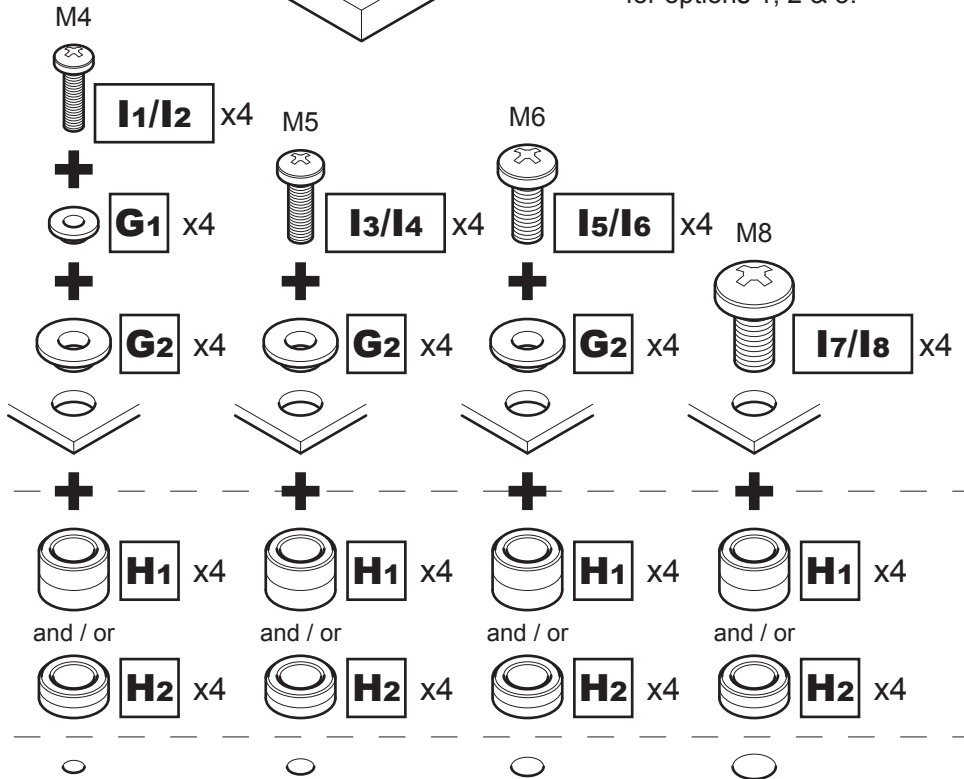

Attach the bracket to the back of your TV using suitable screw, reducer and spacer combinations

4

Fitting the Wall Bracket

Solid Wall

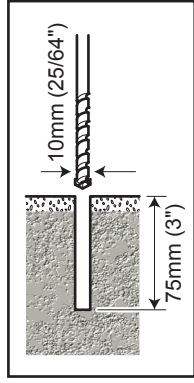
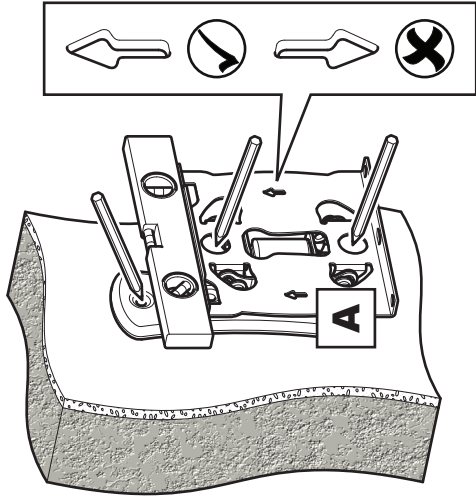

Remove Dust from Hole

Wood Stud

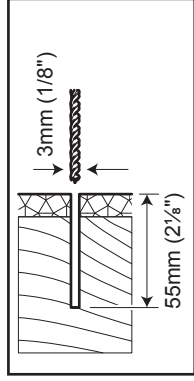
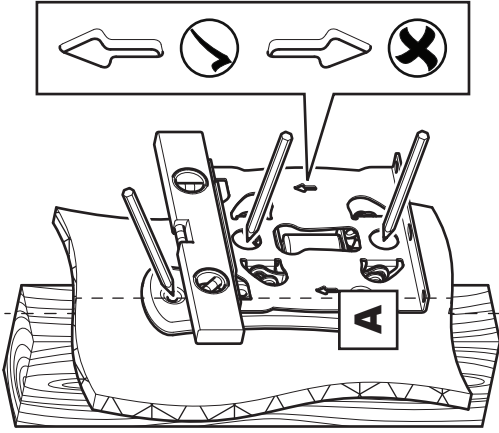
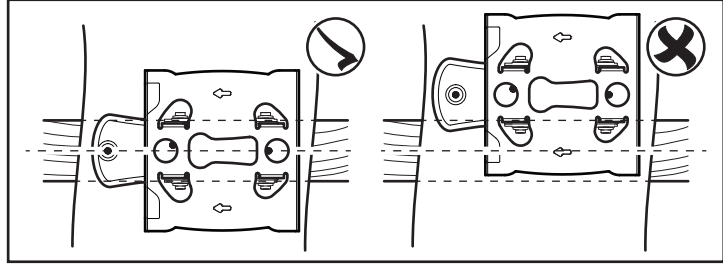

Ensure bracket is in the centre of the wood stud

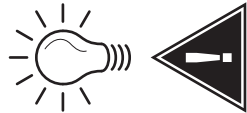
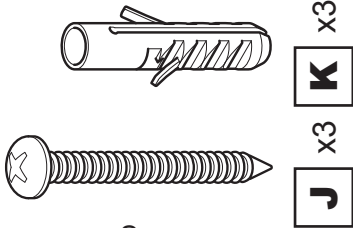
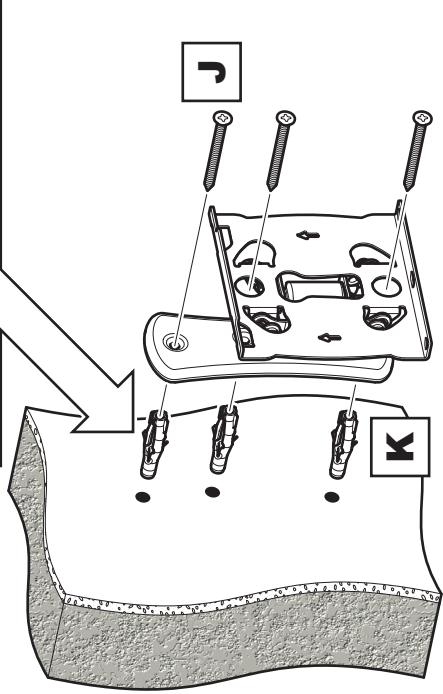
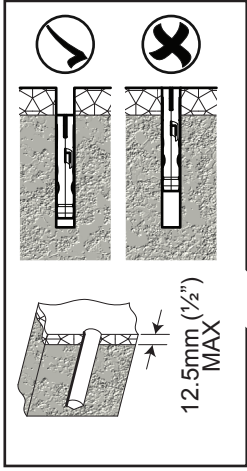

Lubricate screw thread with soap

DO NOT overtighten screws.
Tighten screws by hand only

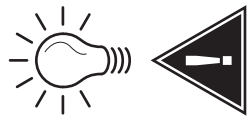
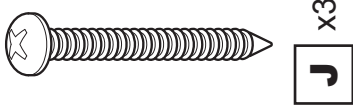
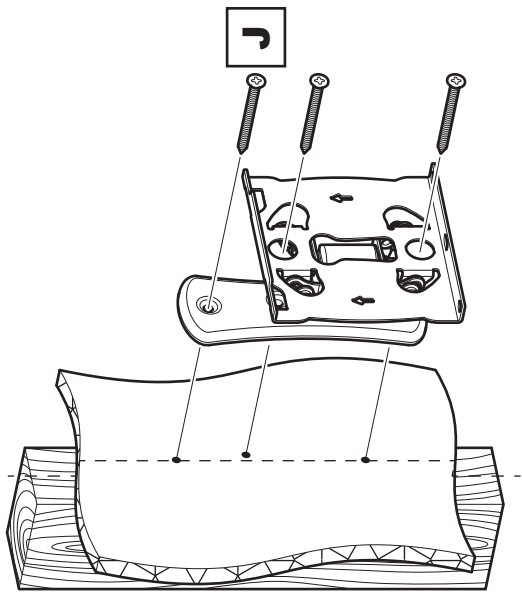

Lubricate screw thread with soap

DO NOT overtighten screws.
Tighten screws by hand only

5 Connecting the TV

Attaching and Locking

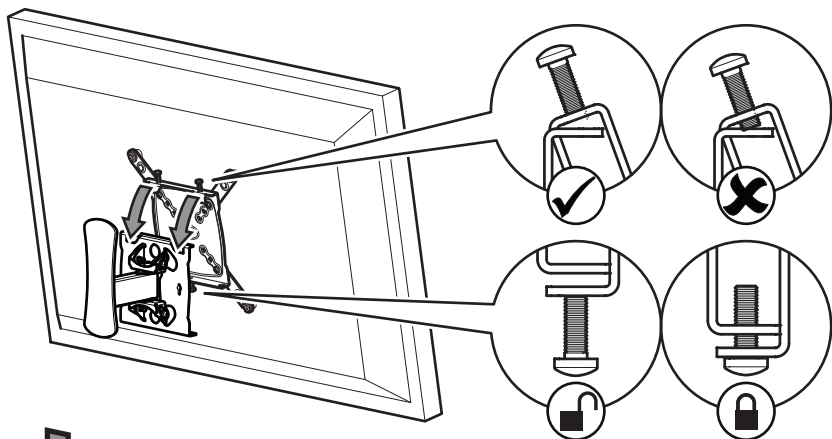

Optional

TV Levelling

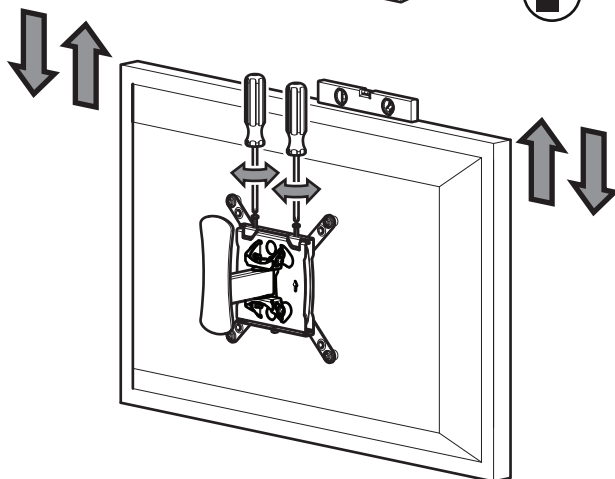

Lock tilt

