

Lisez toutes les instructions avant de débuter l'installation.

Si vous avez des questions sur ce produit ou sur son installation, contactez le service d'assistance clientèle avant de renvoyer le produit au magasin. Rendez vous sur www.avfgroup.com/unimax pour accéder à la vidéo concernant l'installation.

NUMÉRO DE L'ASSISTANCE CLIENT:
+44 (0)1952 670009 (UK)
1-800 667 0808 (USA)

Pour les
TVs jusqu'à

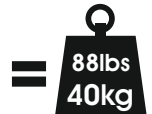
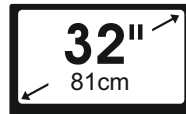

Pour les
TVs jusqu'à

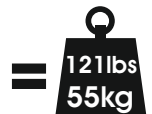

AVF Group Ltd. Hortonwood 30, Telford, Shropshire, TF1 7YE, England
AVF Incorporated 3187, Cornerstone Drive, Eastvale, CA 91752, USA

www.avfgroup.com

Vue d'ensemble de l'assemblage

Raccorde l'adaptateur/les supports de l'écran au téléviseur

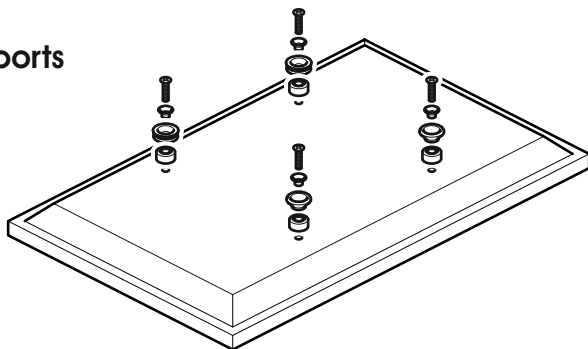

Fixer l'applique murale

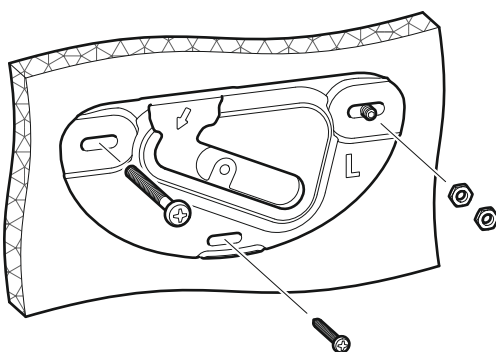

Accrochez le téléviseur

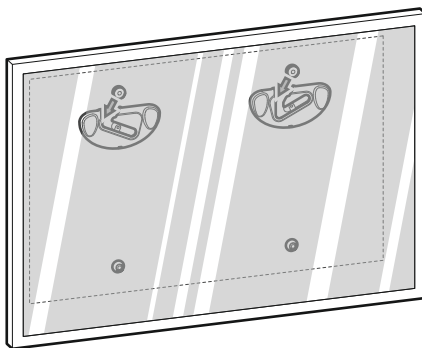

Conserver les emballages si l'applique a besoin d'être ramenée.

Les contenus peuvent varier de la photographie/illustrations.

Vous n'aurez pas besoin de toutes ces pièces, attendez-vous donc à ce qu'il reste des pièces selon les caractéristiques de votre téléviseur.

Ce produit est à utiliser à l'intérieur uniquement. Utiliser ce produit à l'extérieur causera des défaillances et de possibles accidents.

Il est de la responsabilité de l'installateur de s'assurer que les murs soient aux critères requis et vides de tout câblage (ex : gaz, électricité, eau etc....)

AVF n'acceptera aucune responsabilité pour tout dommage ou perte causée par l'installation du produit dans un mur en deçà de ces critères.

Index

1 Mesurer la profondeur et la taille des trous de fixation

Avec l'adaptateur

2 Raccorde l'adaptateur au téléviseur

3 Assemblez le modèle de positionnement

4 Déterminez les trous des crochets

5 Marquage des trous de forage dans le mur

6 Installer l'applique murale

7 Installation des couvercles des supports muraux

8 Accrochez le téléviseur

Sans adaptateur

9 Placez les crochets de fixation sur le téléviseur

10 Assemblez le modèle de positionnement

11 Déterminez les trous des crochets

12 Marquage des trous de forage dans le mur

13 Installer l'applique murale

14 Installation des couvercles des supports muraux

15 Accrochez le téléviseur

Outils recommandés

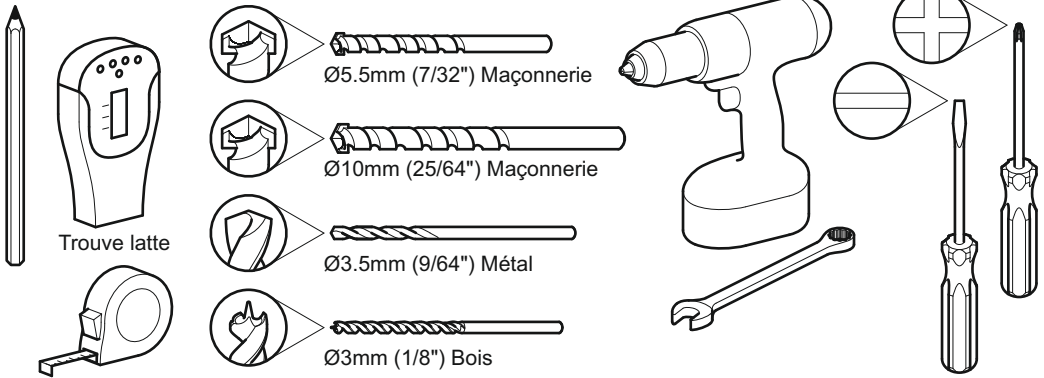

Pièces emballées

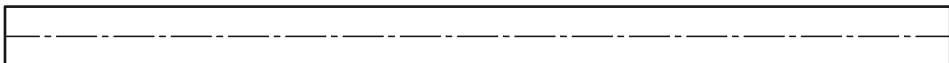
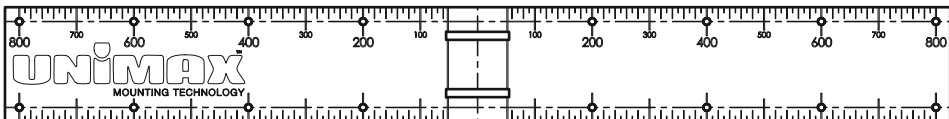
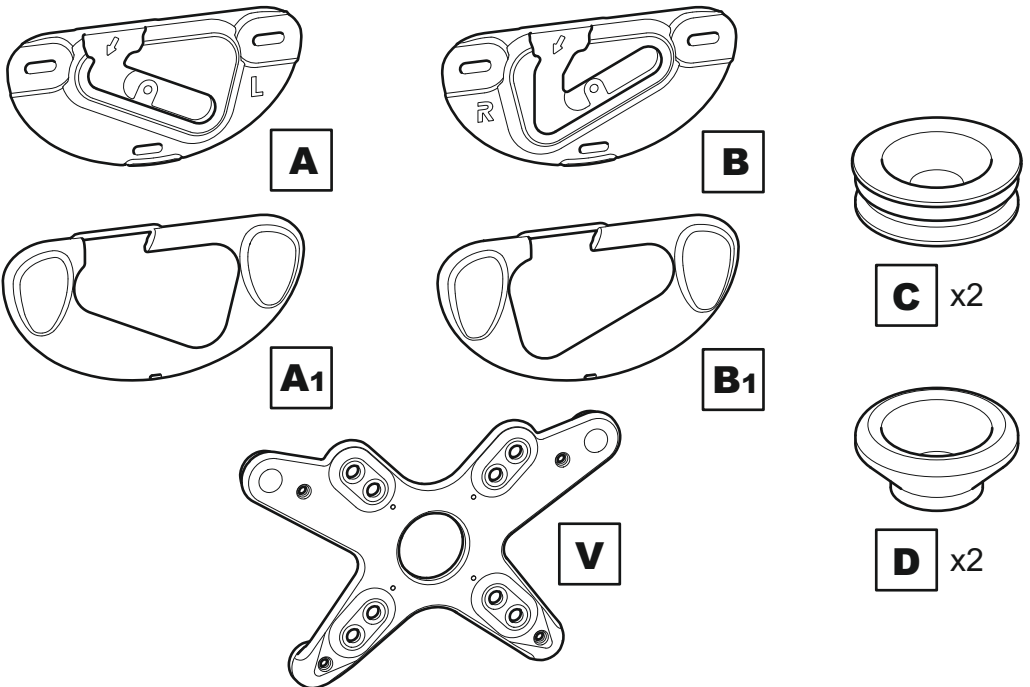

Vis TV, réducteurs et séparateurs

Vous pouvez
seulement
utiliser ces
vis avec
l'adaptateur V

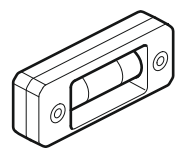
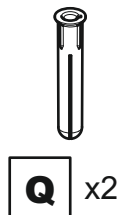
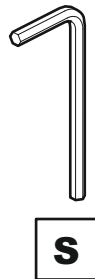
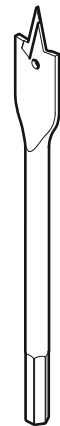
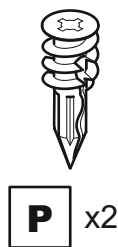
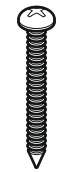
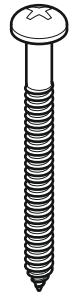
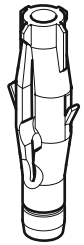
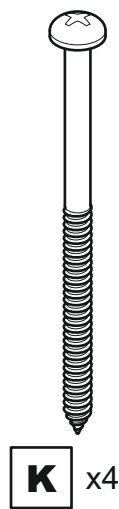
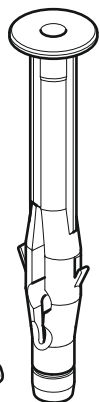
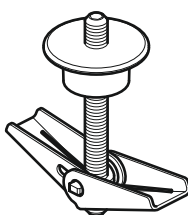
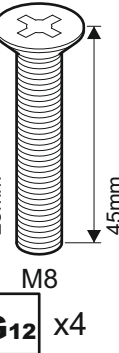
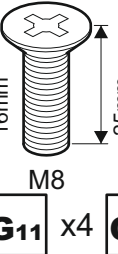
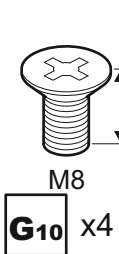
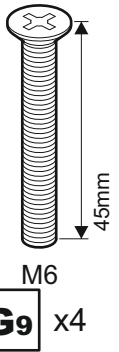
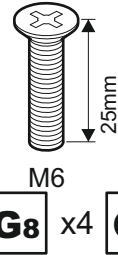
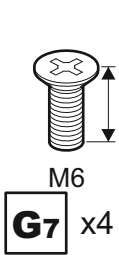
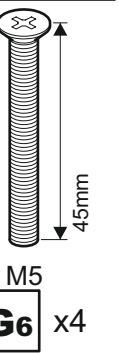
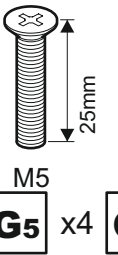
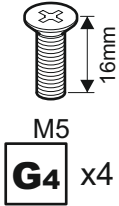
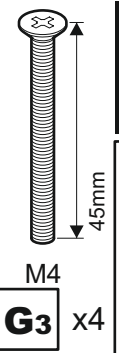
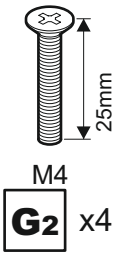
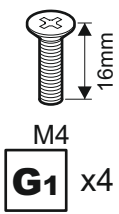

**Retirez les couvercles des consoles murales
et gardez-les pour les étapes 7 ou 14**

Les couvercles de consoles murales **A1** et **B1** s'enlèvent de la même façon.

i



ii

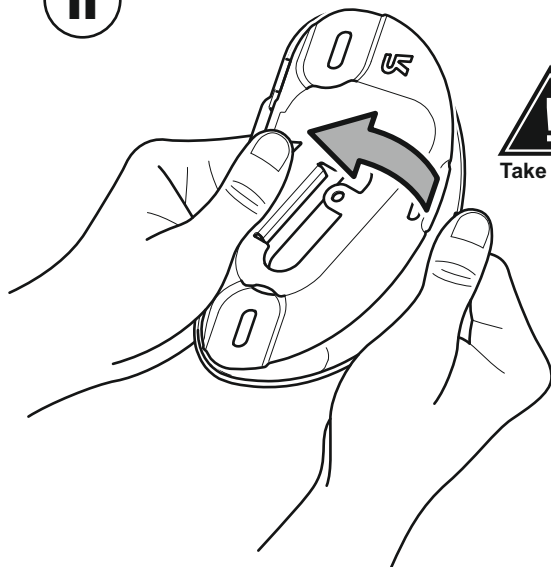

Take Care

1**Mesurer la profondeur et la taille des trous de fixation**

Adaptateur requis (X) = 75 ou 100mm
(Y) = 75 ou 100mm

Aucun adaptateur requis (X) = 200mm à l'infini
(Y) = 200mm à l'infini

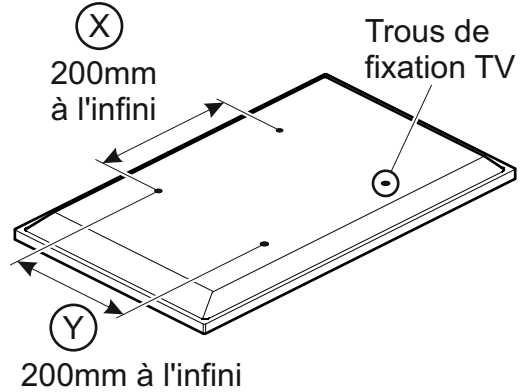
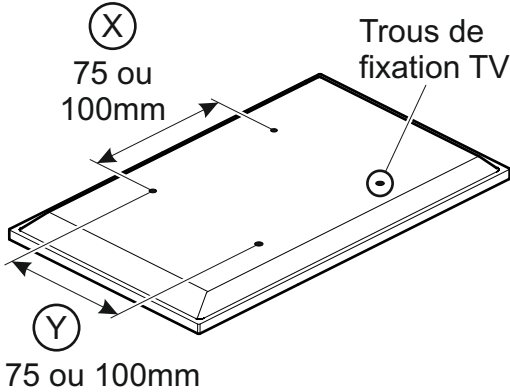

Si la largeur de (X) et la hauteur de (Y) ne sont pas équivalentes à 75 mm ou 100 mm, et si elles sont inférieures à 200 mm, **CESSEZ** l'installation immédiatement et communiquez avec la ligne d'assistance à la clientèle

4 diamètres de vis TV vous sont fournis, **M4**, **M5**, **M6**, et **M8**. Déterminez le diamètre de la vis qui convient et mémorisez- le pour l'étape 2 ou 9.

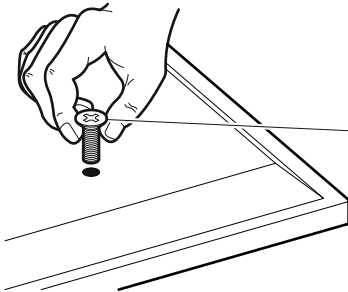

M4 = G1-G3

M5 = G4-G6

M6 = G7-G9

M8 = G10-G12

Avec ou sans adaptateur

La largeur et la hauteur des trous de fixation de votre téléviseur détermineront si vous avez besoin d'utiliser l'adaptateur fourni

Avec l'adaptateur
Suivez les étapes 2 à 8



Sans adaptateur
Suivez les étapes 9 à 15



Une fois que vous aurez trouvé le diamètre de la vis appropriée aux besoins de votre téléviseur, vous devrez choisir l'espaceur mural nécessaire. Regardez derrière votre téléviseur, puis choisissez L'**OPTION** qui convient à votre téléviseur. Voir le verso de la page pour de plus amples renseignements.

OPTION 1

20mm Espacement

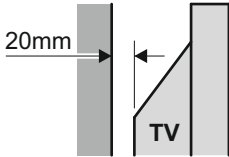

Convient aux téléviseurs avec un dos plat et aucune obstruction

OPTION 2

30mm Espacement

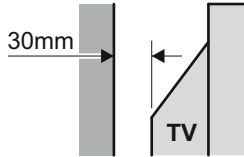

Convient aux téléviseurs avec des obstructions petites à moyennes, comme le bloc d'alimentation, les moulures, etc.

OPTION 3

50mm Espacement

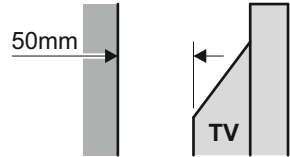

Convient aux téléviseurs avec de grandes obstructions comme le bloc d'alimentation, les moulures, etc.

Fixations supérieures**G1-G12****F1-F3**

Si nécessaire

V**Fixations inférieures****G1-G12****F1-F3**

Si nécessaire

E1

Si nécessaire *

* Si nécessaire

Haut

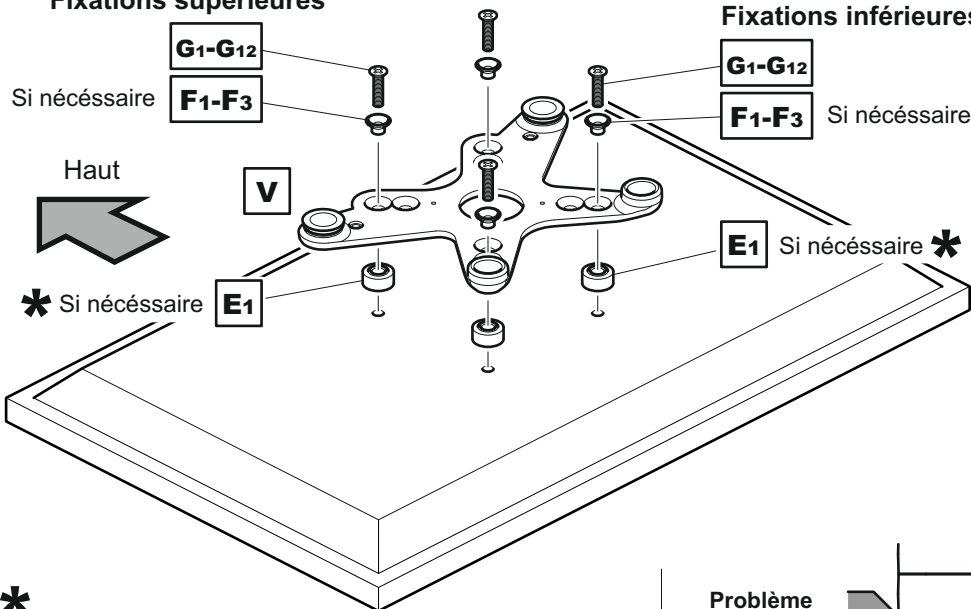

Dans certaines circonstances il peut être nécessaire d'utiliser les écarteurs rouges **E2** pour remplacer ou compléter l'écarteur **E1**.

Quand est-il nécessaire d'utiliser les écarteurs rouges **E2**?

Il est recommandé que lorsque vous raccordez l'adaptateur **V** à votre téléviseur, vous avez une marge de manœuvre de 5 à 10 mm pour la vis.

Dans certaines circonstances vous pouvez avoir besoin d'utiliser les écarteurs rouge **E2** en remplacement ou en complément des écarteurs **E1** pour y parvenir. Si vous utilisez les écarteurs rouges **E2** vous devez utiliser les 4.

Problème
Vis pas assez insérer

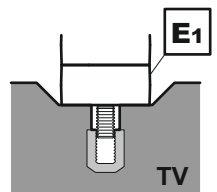



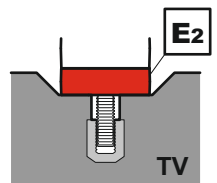



















Solution
L'écarteur rouge **E2** a remplacé l'écarteur **E1**



OPTION 1
20mm Espacement

Fixations supérieures































Fixations inférieures

M4	M5	M6	M8	M4	M5	M6	M8
 G1	 G4	 G7	 G10	 G1	 G4	 G7	 G10
 F1	 F2	 F3		 F1	 F2	 F3	
 V	 V	 V	 V	 V	 V	 V	 V

OPTION 2
30mm Espacement

Fixations supérieures















































Fixations inférieures

M4	M5	M6	M8	M4	M5	M6	M8
 G2	 G5	 G8	 G11	 G2	 G5	 G8	 G11
 F1	 F2	 F3		 F1	 F2	 F3	
 V	 V	 V	 V	 V	 V	 V	 V
 E1	 E1	 E1	 E1	 E1	 E1	 E1	 E1

OPTION 3
50mm Espacement

Fixations supérieures

Fixations inférieures

M4	M5	M6	M8	M4	M5	M6	M8
 G3	 G6	 G9	 G12	 G3	 G6	 G9	 G12
 F1	 F2	 F3		 F1	 F2	 F3	
 V	 V	 V	 V	 V	 V	 V	 V
 E1	 E1	 E1	 E1	 E1	 E1	 E1	 E1
 E1	 E1	 E1	 E1	 E1	 E1	 E1	 E1
 E1	 E1	 E1	 E1	 E1	 E1	 E1	 E1

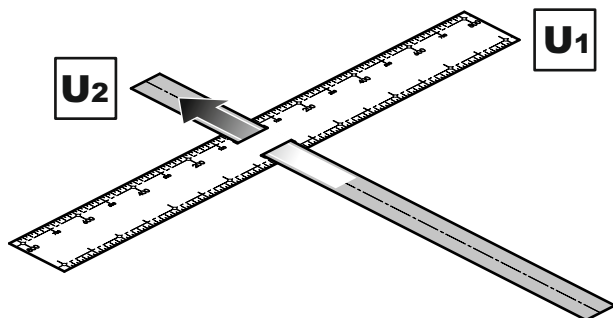
3**Assemblez le modèle de positionnement****Avec l'adaptateur****4****Déterminez les trous des crochets****Avec l'adaptateur**

Placez le modèle à l'arrière du téléviseur et suivez les instructions ci-dessous.

Placez la rangée supérieure de trous sur le modèle **U1** sur l'adaptateur **V**.
Marquez les 200 centres de fixation

La ligne centrale du modèle **U2** représente le centre de votre téléviseur

Alignez le haut de l'écran.

Haut

Les trous de la rangée supérieure

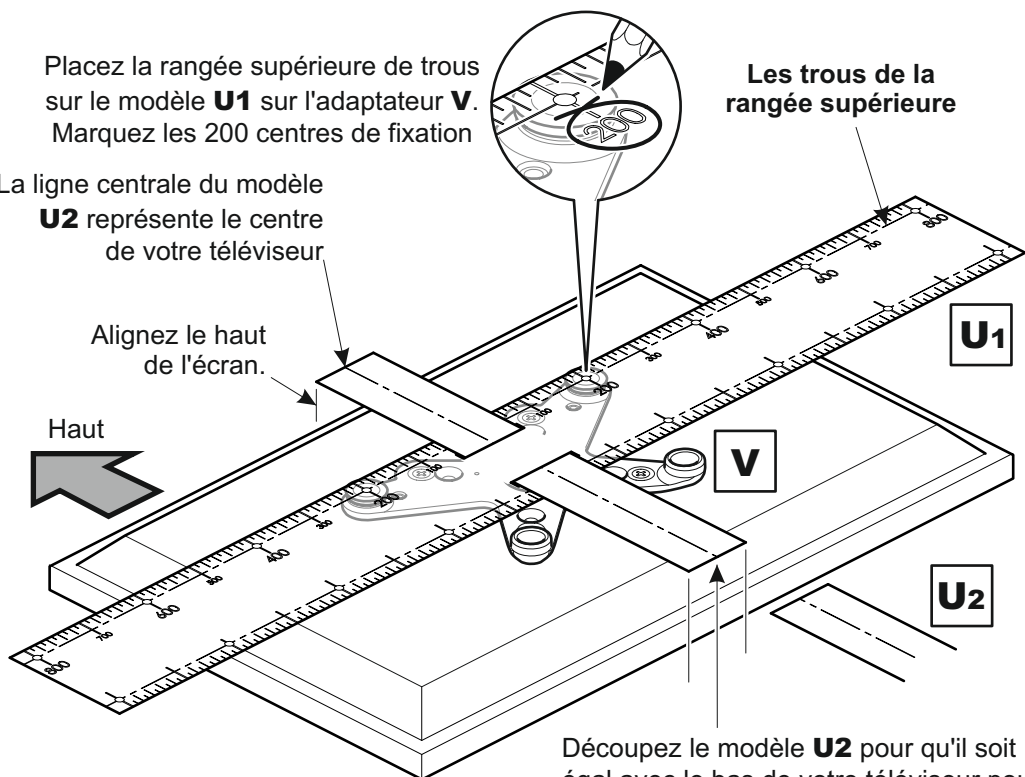

Découpez le modèle **U2** pour qu'il soit égal avec le bas de votre téléviseur pour que lorsque le modèle est sur le mur, vous voyez exactement l'endroit où votre téléviseur sera vertical (distance du plancher et du plafond)

5

Marquage des trous de forage dans le mur

Avec l'adaptateur

Avant de marquer le mur, déterminez le type de mur (mur solide / Plaque de Plâtre Adhésif / placoplâtre/ bois boulonné / colombage métallique).

Assurez-vous que la région de perçage est libre de services principaux (essence/électricité/eau).

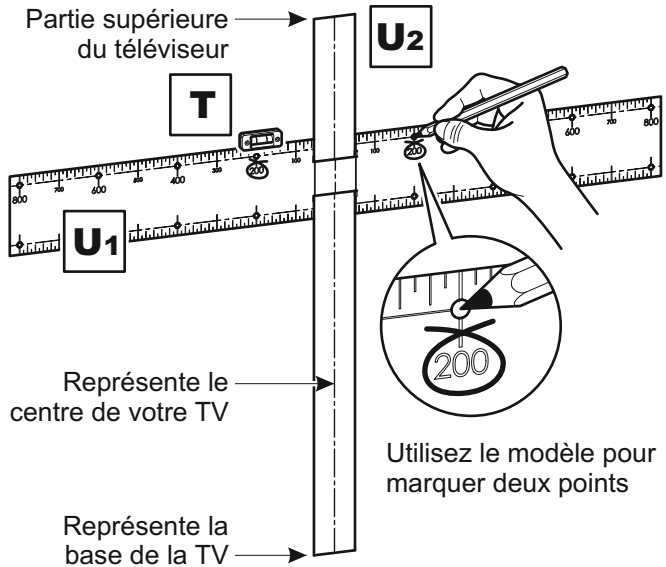

Ensuite, utilisez les consoles murales **A** et **B** comme modèles, puis placez-les sur les **MARQUES DE CRAYON** appropriées que vous avez tracées, de façon à ce que la marque se trouve au milieu du **TROU CENTRAL** de la console murale. Assurez-vous que la console est à niveau et marquez trois **POINTS DE PERÇAGE** à l'aide d'un crayon. Recommencez pour l'autre console. Recommencez pour l'autre console. Percez six trous pilotes de 3 mm, puis sélectionnez les fixations appropriées (voir la section 6).

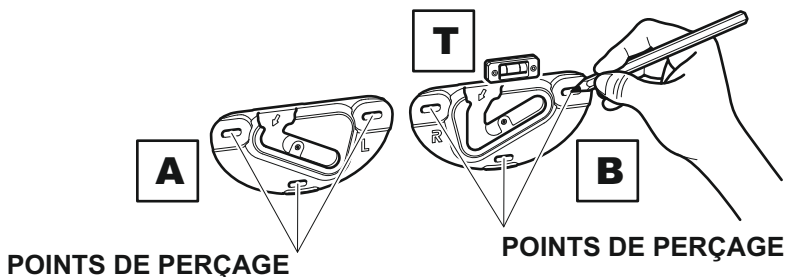
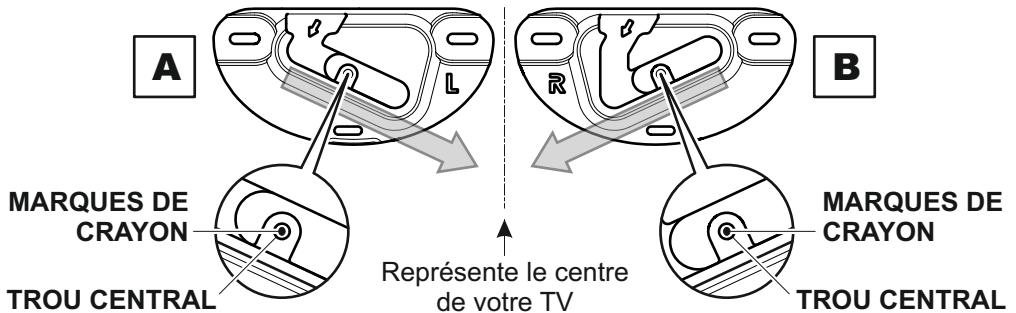

6

Installer l'applique murale

Avec l'adaptateur

Utilisez les fixations adaptées à votre type de mur. Il sera peut-être nécessaire d'utiliser plusieurs types de fixations pour les installations couvrant différents types de murs.
NE SERREZ PAS EXCESSIVEMENT LES VIS.

Mur Solide

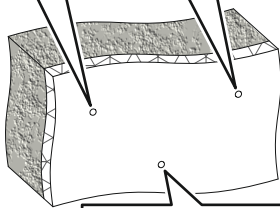
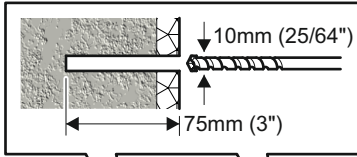

Retirer la poussière du trou

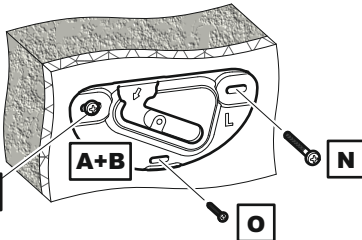
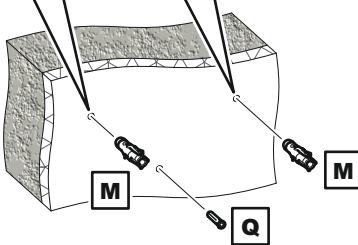
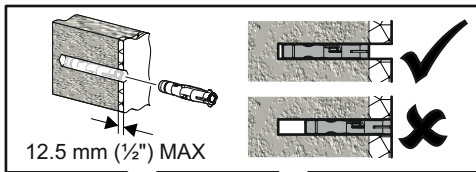
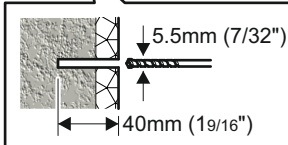

Lubrifiez le pas de vis avec du savon

Plaque de Plâtre Adhésif

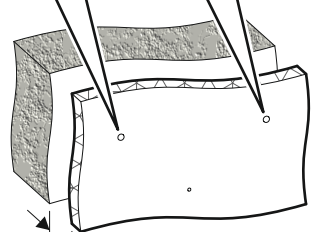
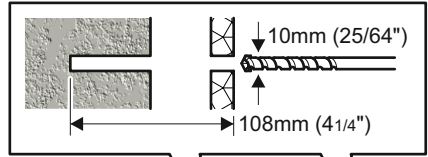

* 40mm (1 9/16") MAX gap

* Si l'espace est supérieur à 40mm (1 9/16"), utilisez la méthode de fixation pour plâtre et plaques de plâtre



Enlevez la poussière du trou

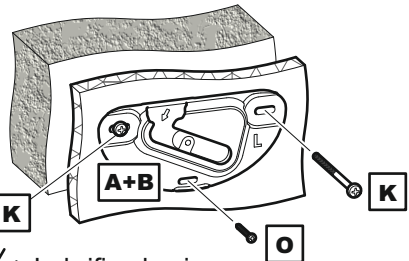
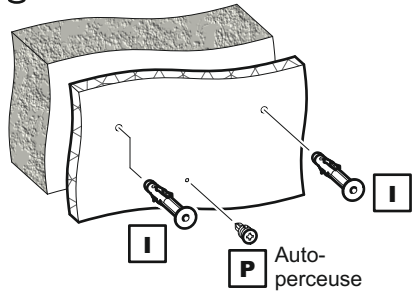

Lubrifiez la vis avec du savon

Placoplâtre

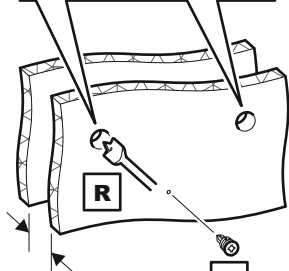
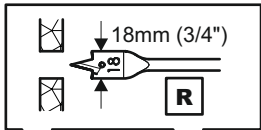

* 40mm (1 9/16")
Espace Minimum Auto-perceuse



Retirer la poussière du trou

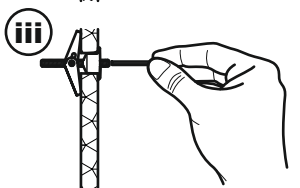
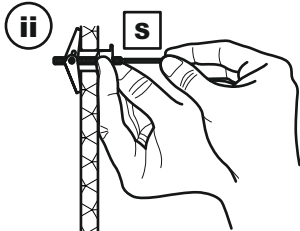
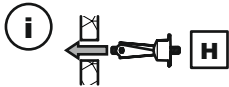

Vissez à fond, sans excès

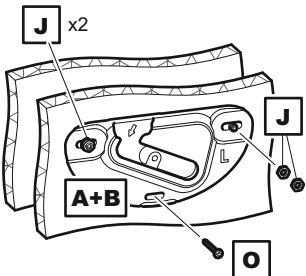

Montant en Bois

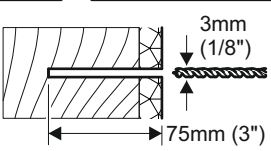
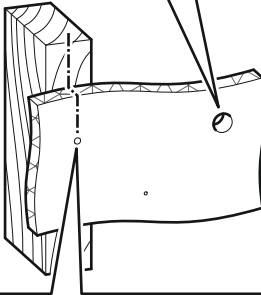
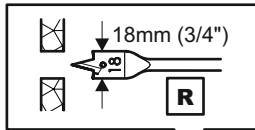

Assurez-vous qu'elle se trouve au milieu du bois boulonné

Utilisez la fixation **H** du placoplâtre

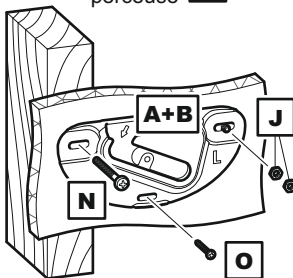
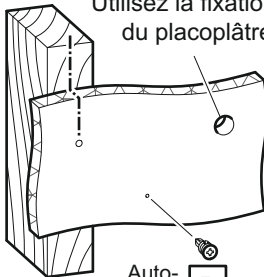

Lubrifiez la vis avec du savon

Une seule fixation sur le montant en bois. Les autres dans le placoplâtre (voir ci-dessus).

Montant en Métal

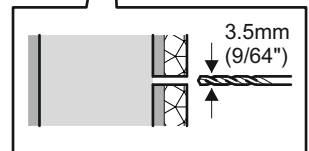
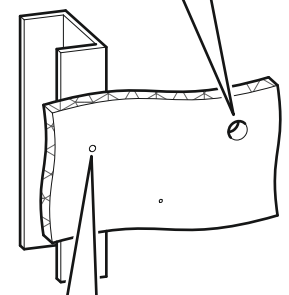
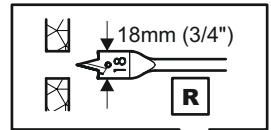

Utilisez la fixation **H** du placoplâtre

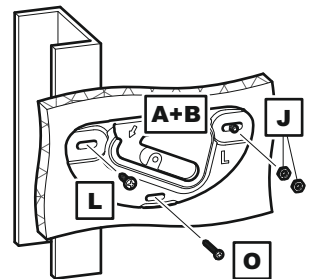
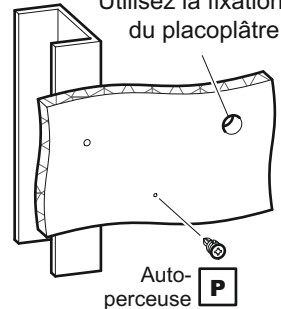

Une seule fixation dans le montant en métal. Les autres dans le placoplâtre (voir ci-dessus).

7

Installation des couvercles des supports muraux

Avec l'adaptateur

Sur les couvercles de consoles murales **A1** et **B1** se trouvent 3 pattes de retenues. Elles se trouvent sur 3 lèvres de retenues de la console murale **A** et **B**, puis verrouiller les couvercles de consoles murales en place.

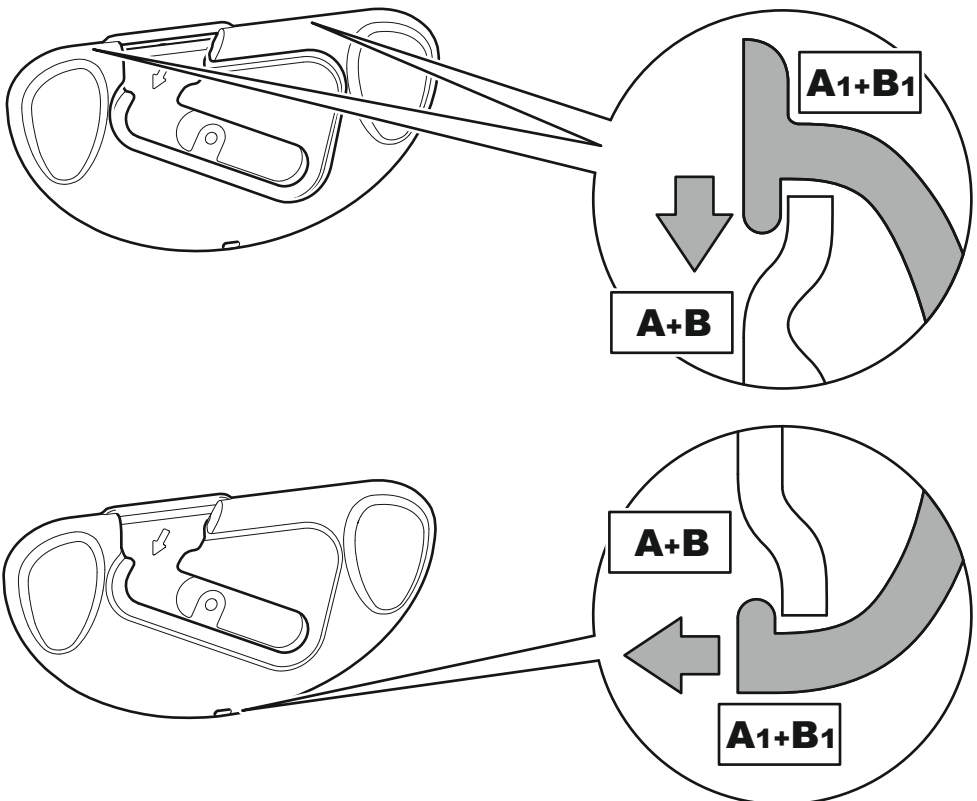
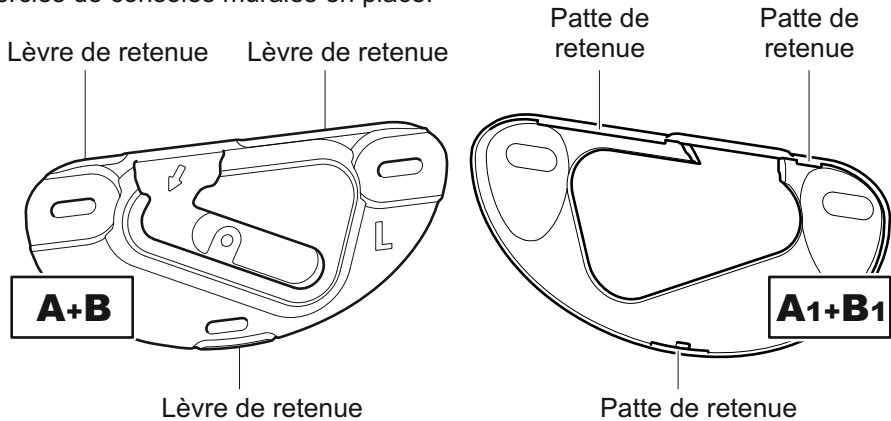

8

Accrochez le téléviseur

Avec l'adaptateur

Deux personnes sont nécessaires pour accrocher le téléviseur au mur.

Présentez l'adaptateur **V** (à l'arrière du téléviseur) par l'ouverture sur les consoles **A** et **B**. Glissez vers le bas et au travers pour stabiliser. Assurez-vous que l'adaptateur est entièrement engagé. Si les câbles à l'arrière de l'écran empêchent la TV de reposer verticalement contre le mur, la configuration alternative des accroches est nécessaire. (voir la section 2).

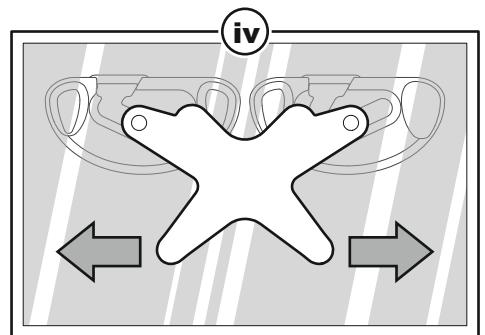
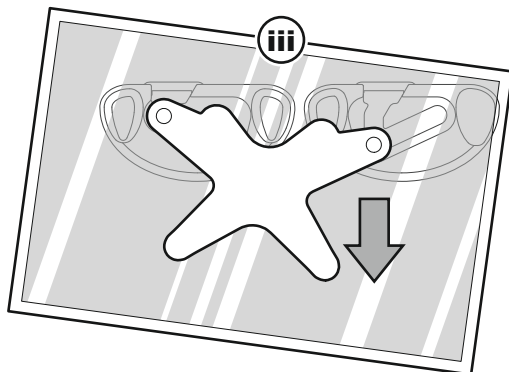
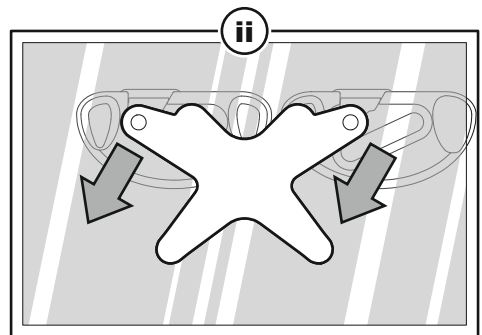
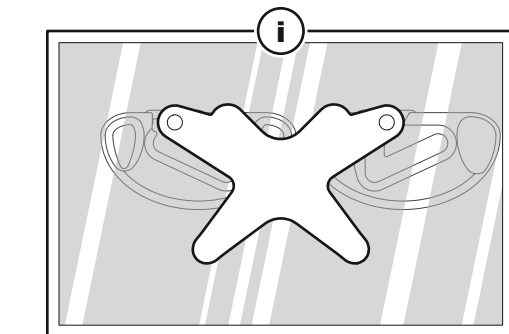
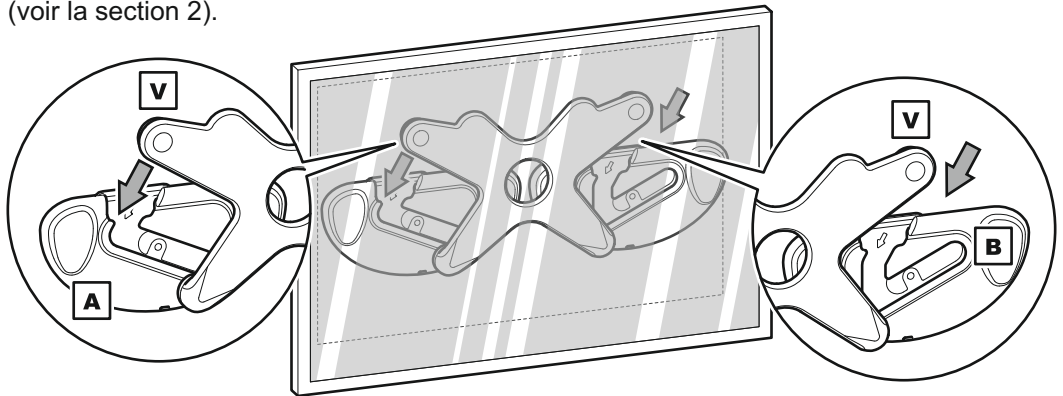

Si nécessaire vous pouvez ajuster le nivellement de votre TV en l'inclinant de côté

Pour libérer la TV

C'est un travail qui nécessite 2 personnes. Pour libérer la TV du support, inverser les mouvements comme décrit ci-dessus

9

Placez les crochets de fixation sur le téléviseur

Sans adaptateur

Une fois que vous aurez trouvé le diamètre de la vis appropriée aux besoins de votre téléviseur, vous devrez choisir l'espaceur mural nécessaire. Regardez derrière votre téléviseur, puis choisissez L'OPTION qui convient à votre téléviseur. Voir le verso de la page pour de plus amples renseignements.

OPTION 1

12mm Espacement

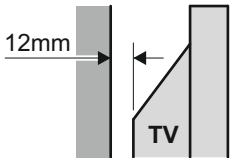

Convient aux téléviseurs avec un dos plat et aucune obstruction

OPTION 2

20mm Espacement

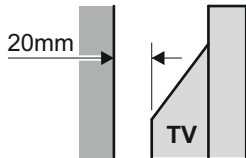

Convient aux téléviseurs avec des obstructions petites à moyennes, comme le bloc d'alimentation, les moulures, etc.

OPTION 3

40mm Espacement

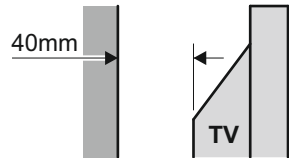

Convient aux téléviseurs avec de grandes obstructions comme le bloc d'alimentation, les moulures, etc.

Fixations supérieures

Fixations inférieures

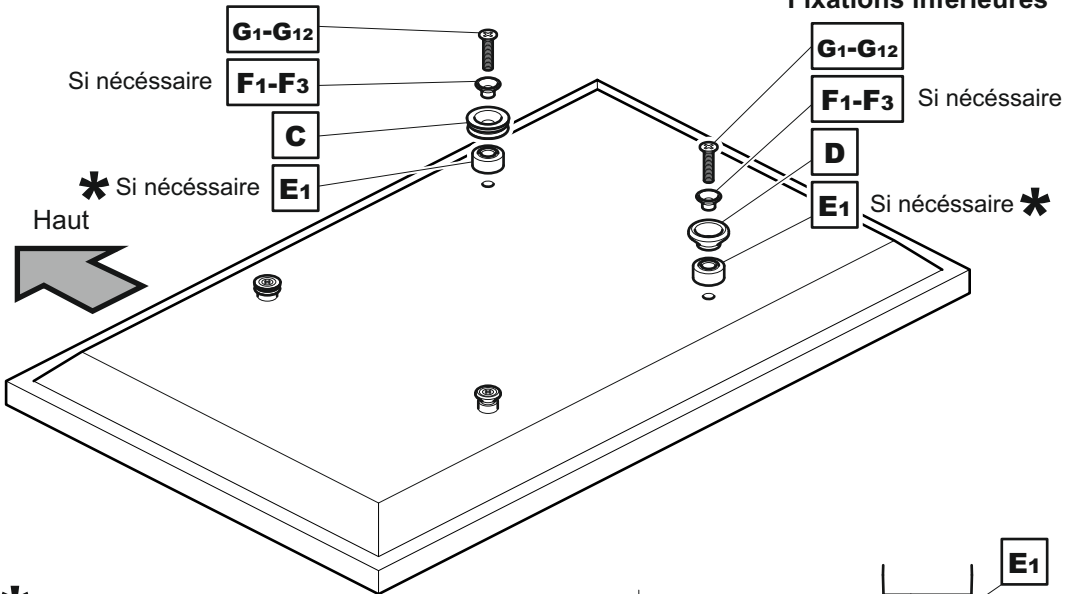

Dans certaines circonstances il peut être nécessaire d'utiliser les écarteurs rouges **E2** pour remplacer ou compléter l'écarteur **E1**.

Quand est-il nécessaire d'utiliser les écarteurs rouges **E2**?

Il est conseillé que lorsque vous fixez les accroche **C** et cales **D** à votre TV vous ayez au moins 5 à 10mm d'engagement de la vis. Dans certaine circonstances vous pouvez avoir besoin d'utiliser les écarteurs rouge **E2** en remplacement ou en complément des écarteurs **E1** pour y parvenir. Si vous utilisez les écarteurs rouges **E2** vous devez utiliser les 4.

Problème
Vis pas assez insérer

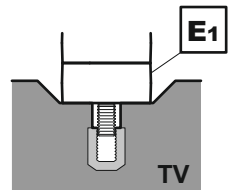



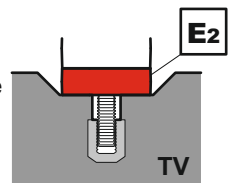







Solution
L'écarteur rouge **E2** a remplacé l'écarteur **E1**













OPTION 1
12mm Espacement

Fixations supérieures

M4	M5	M6	M8
 G1	 G4	 G7	 G10
 F1	 F2	 F3	
 C	 C	 C	 C











Fixations inférieures

M4	M5	M6	M8
 G1	 G4	 G7	 G10
 F1	 F2	 F3	
 D	 D	 D	 D











OPTION 2
20mm Espacement

Cette OPTION ne convient pas aux vis M4 de G1-3

Fixations supérieures

M5	M6	M8
 G5	 G8	 G11
 F2	 F3	
 C	 C	 C
 E1	 E1	 E1











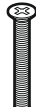
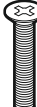



Fixations inférieures

M5	M6	M8
 G5	 G8	 G11
 F2	 F3	
 D	 D	 D
 E1	 E1	 E1

















OPTION 3
40mm Espacement

Cette OPTION ne convient pas aux vis M4 de G1-3

Fixations supérieures

M5	M6	M8
 G6	 G9	 G12
 F2	 F3	
 C	 C	 C
 E1	 E1	 E1
 E1	 E1	 E1
 E1	 E1	 E1

Fixations inférieures

M5	M6	M8
 G6	 G9	 G12
 F2	 F3	
 D	 D	 D
 E1	 E1	 E1
 E1	 E1	 E1
 E1	 E1	 E1

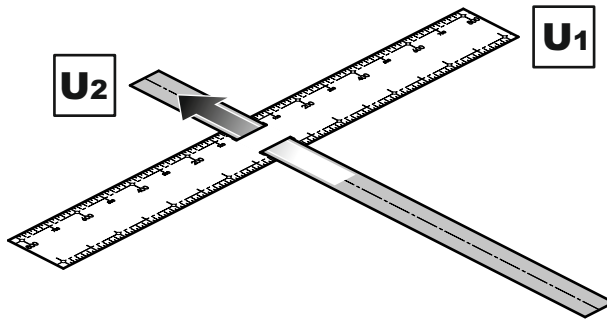
10**Assemblez le modèle de positionnement****Sans adaptateur****11****Déterminez les trous des crochets****Sans adaptateur**

Placez le modèle à l'arrière du téléviseur et suivez les instructions ci-dessous.

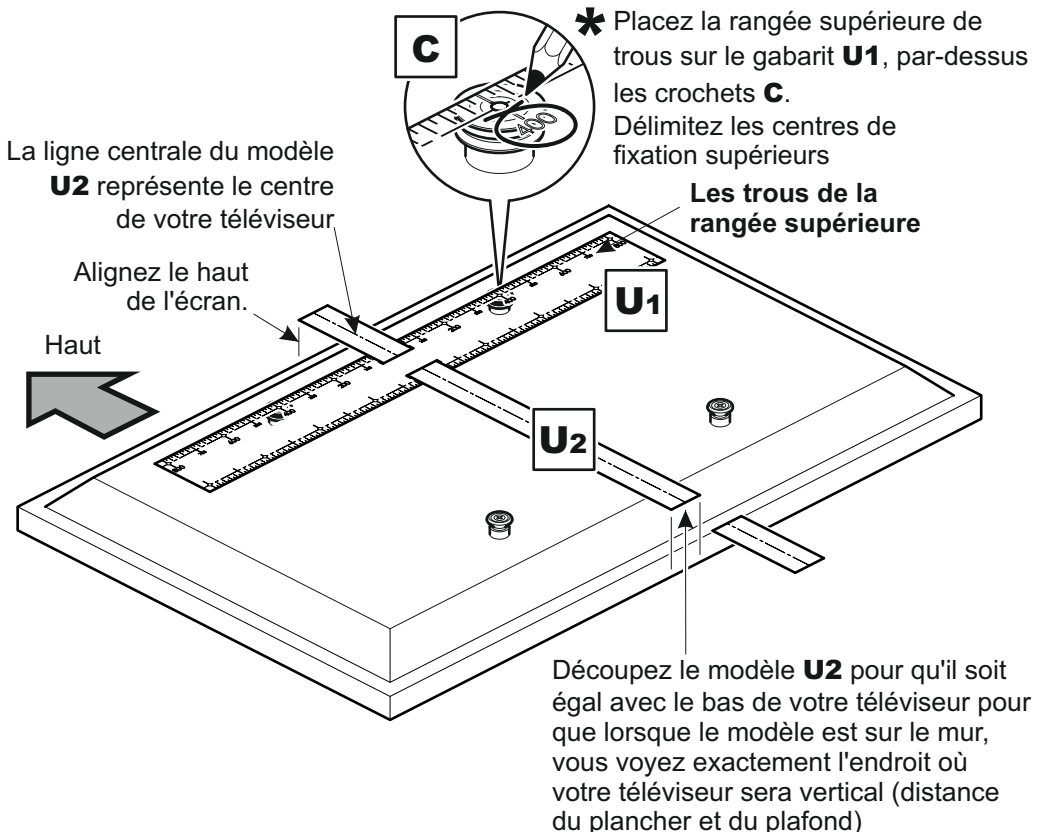

* Si les crochets **C** ne sont alignés avec aucun des trous du gabarit, alors assurez-vous que ce dernier est bien en place, puis poinçonnez 2 trous avec un crayon ou un objet pointu de sorte qu'ils correspondent avec les centres de fixation supérieurs.

12 Marquage des trous de forage dans le mur

Sans adaptateur

Avant de marquer le mur, déterminez le type de mur (mur solide / Plaque de Plâtre Adhésif / placoplâtre/ bois boulonné / colombage métallique).

Assurez-vous que la région de perçage est libre de services principaux (essence/électricité/eau).

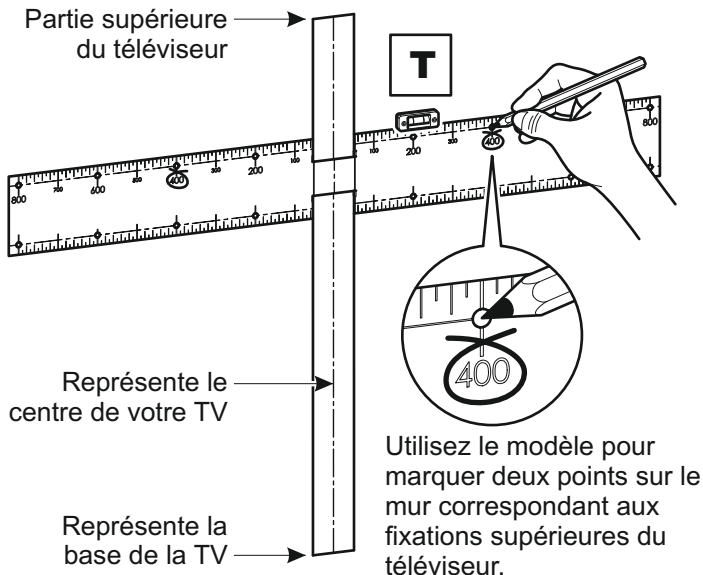

Ensuite, utilisez les consoles murales **A** et **B** comme modèles, puis placez-les sur les **MARQUES DE CRAYON** appropriées que vous avez tracées, de façon à ce que la marque se trouve au milieu du **TROU CENTRAL** de la console murale. Assurez-vous que la console est à niveau et marquez trois **POINTS DE PERÇAGE** à l'aide d'un crayon. Recommencez pour l'autre console. Recommencez pour l'autre console. Percez six trous pilotes de 3 mm, puis sélectionnez les fixations appropriées (voir la section 13).

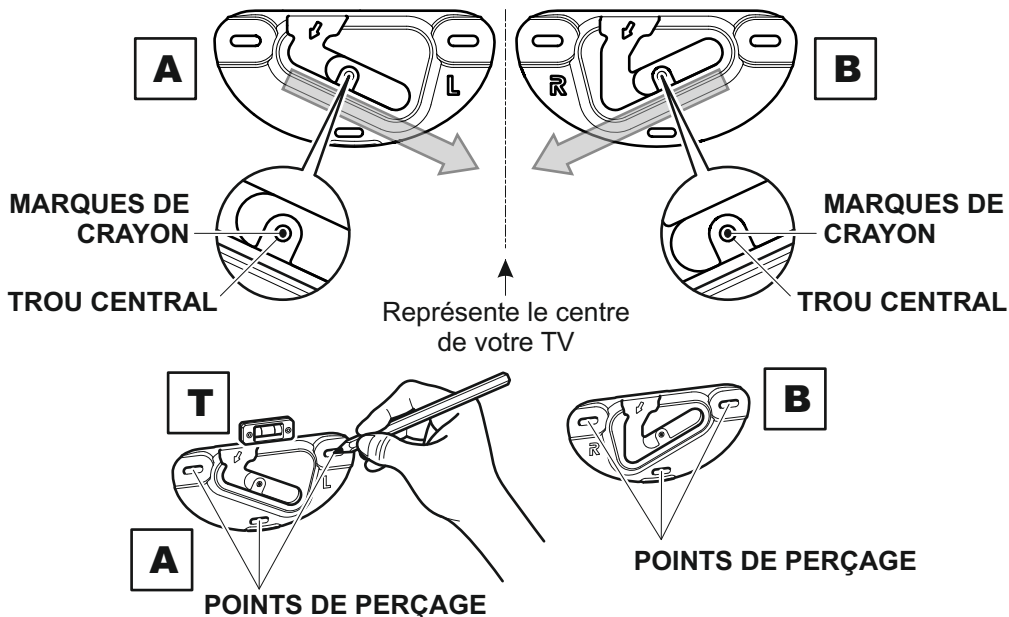

13 Installer l'applique murale

Sans adaptateur

Utilisez les fixations adaptées à votre type de mur. Il sera peut-être nécessaire d'utiliser plusieurs types de fixations pour les installations couvrant différents types de murs.
NE SERREZ PAS EXCESSIVEMENT LES VIS.

Mur Solide

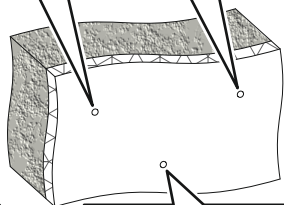
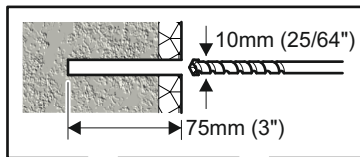

Retirer la poussière du trou

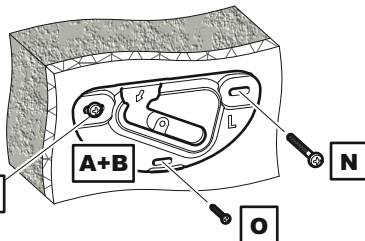
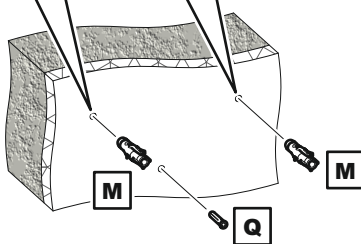
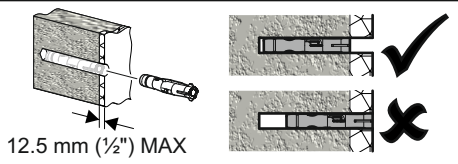
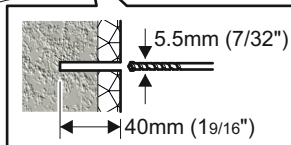

Lubrifiez le pas de vis avec du savon

Plaque de Plâtre Adhésif

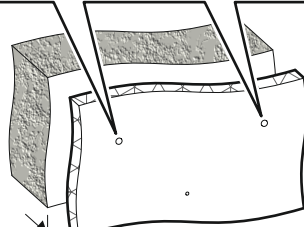
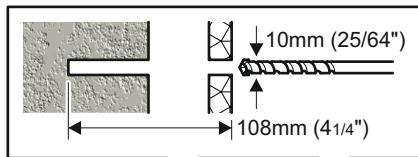

* 40mm (1 9/16") MAX gap

* Si l'espace est supérieur à 40mm (1 9/16"), utilisez la méthode de fixation pour plâtre et plaques de plâtre



Enlevez la poussière du trou

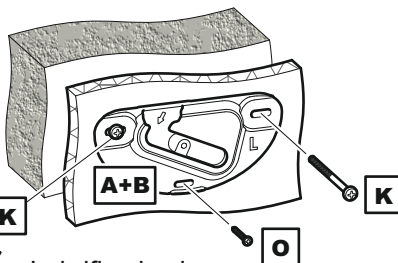
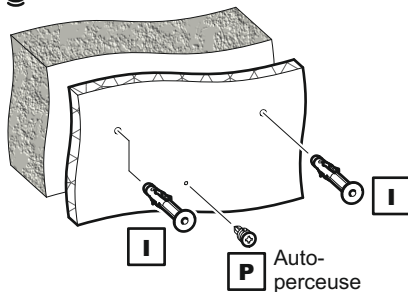

Lubrifiez la vis avec du savon

Placoplâtre

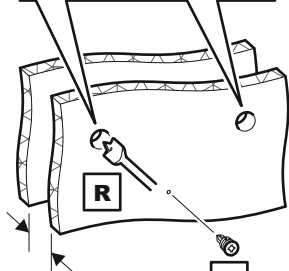
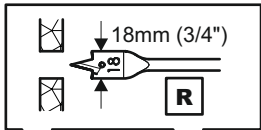

* 40mm (1 9/16")
Espace Minimum Auto-perceuse



Retirer la poussière du trou

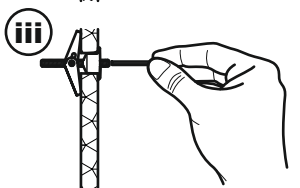
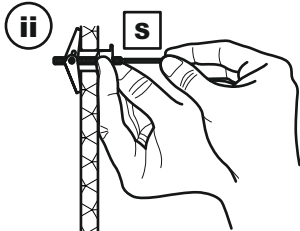
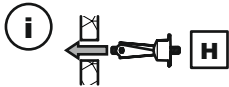

Vissez à fond, sans excès

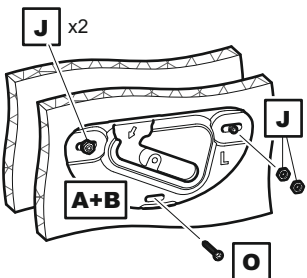

Montant en Bois

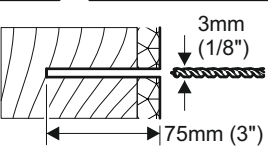
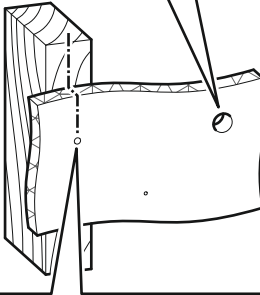
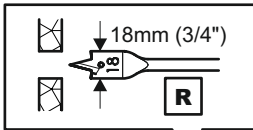

Assurez-vous qu'elle se trouve au milieu du bois boulonné

Utilisez la fixation **H** du placoplâtre

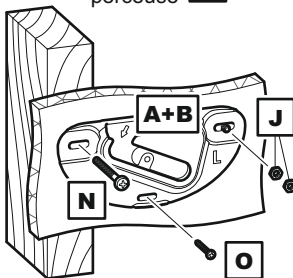
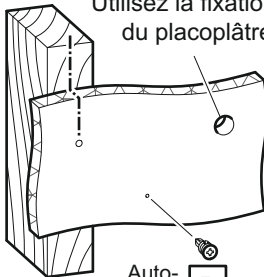

Lubrifiez la vis avec du savon

Une seule fixation sur le montant en bois. Les autres dans le placoplâtre (voir ci-dessus).

Montant en Métal

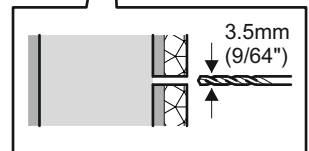
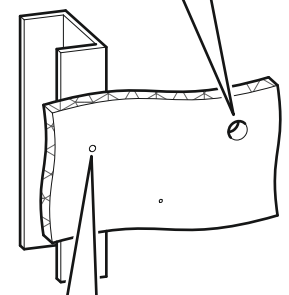
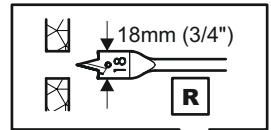

Utilisez la fixation **H** du placoplâtre

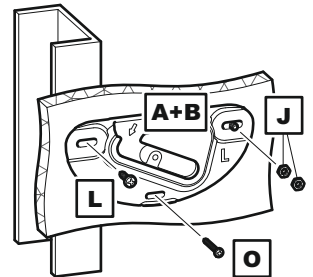
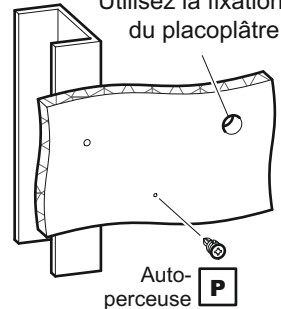

Une seule fixation dans le montant en métal. Les autres dans le placoplâtre (voir ci-dessus).

14 Installation des couvercles des supports muraux

Sans adaptateur

Sur les couvercles de consoles murales **A1** et **B1** se trouvent 3 pattes de retenues. Elles se trouvent sur 3 lèvres de retenues de la console murale **A** et **B**, puis verrouiller les couvercles de consoles murales en place.

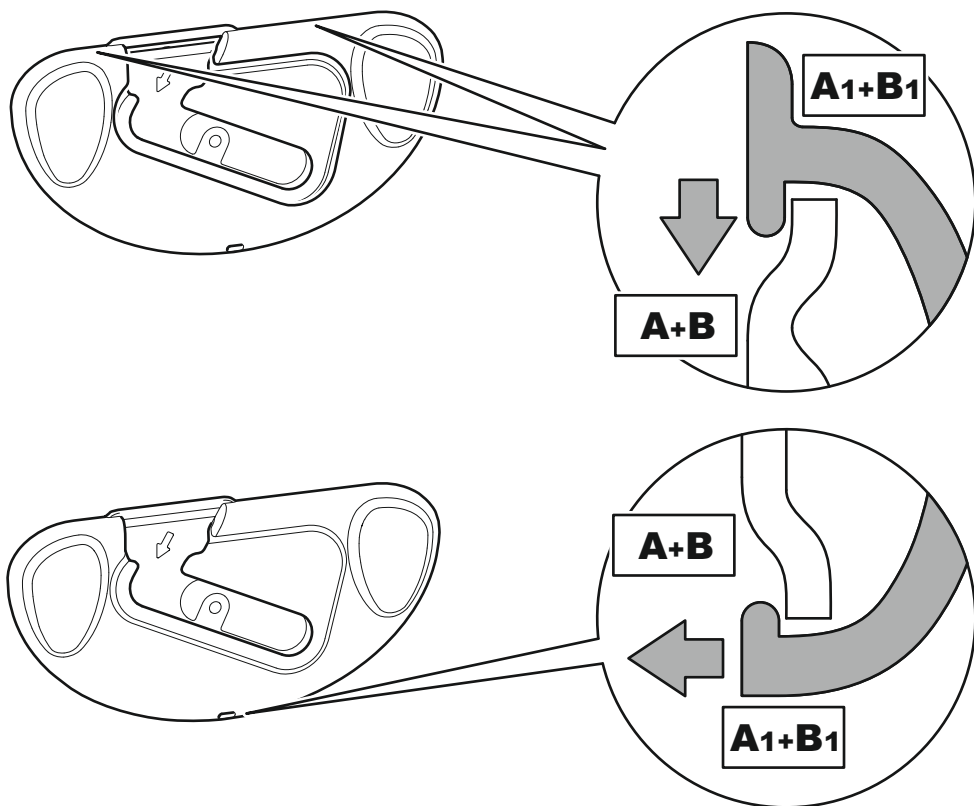
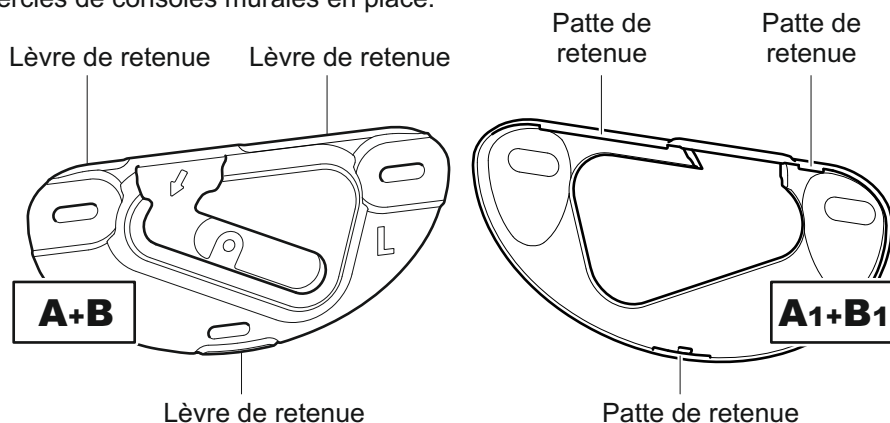

15 Accrochez le téléviseur

Sans adaptateur

Deux personnes sont nécessaires pour mettre en place le téléviseur.

Alignez les crochets **C** (à l'arrière du téléviseur) avec l'ouverture des fixations **A** & **B**. Faites glisser votre TV vers le bas des rails de guidage. Assurez-vous que les 2 accroches soient totalement engagées. Si les câbles à l'arrière de l'écran empêchent la TV de reposer verticalement contre le mur, la configuration alternative des accroches est nécessaire. (voir la section 9).

La TV doit toujours être parallèle au mur. Utilisez des entretoises/douilles-entretoises autosertissables comme indiqué dans la section 9.

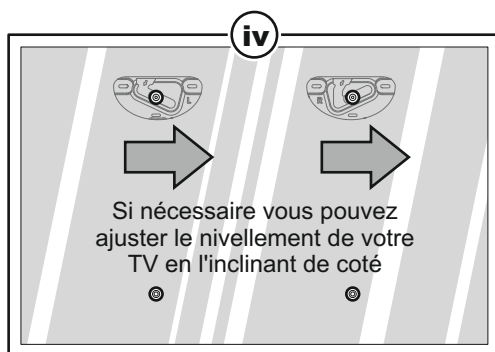
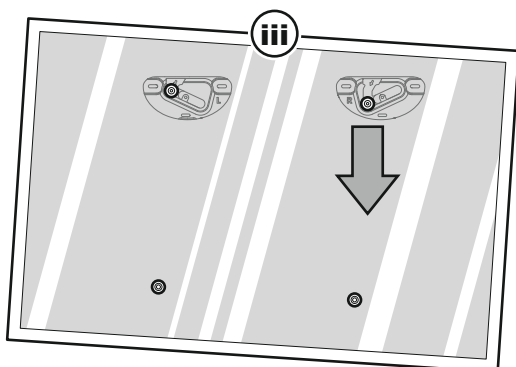
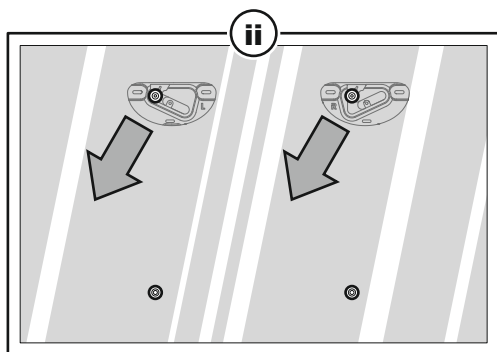
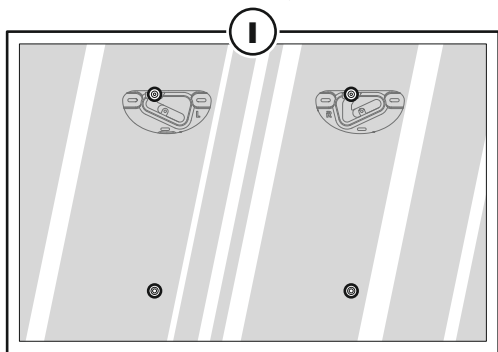
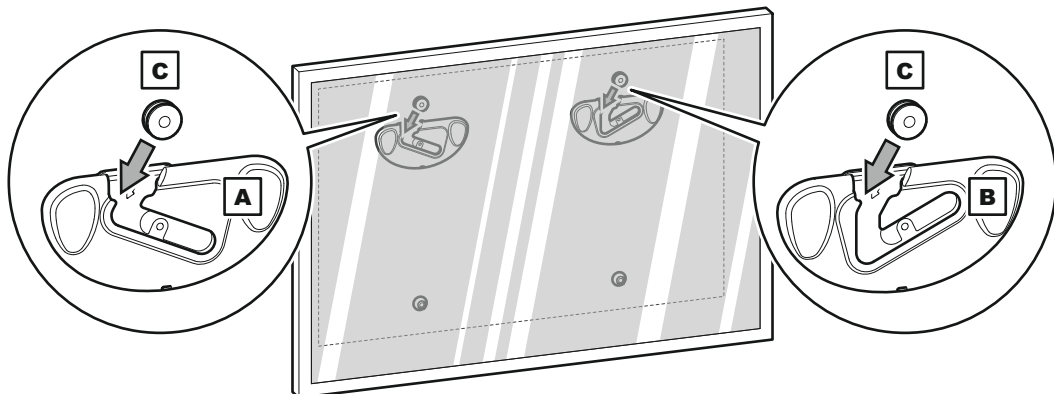

Pour libérer la TV

C'est un travail qui nécessite 2 personnes. Pour libérer la TV du support, inverser les mouvements comme décrit ci-dessus

Pour déclipser la plaque supérieure du support

Si vous souhaitez enlever les couvercles de la console murale, suivez les étapes ci-dessous

