

465101 rev00 ##

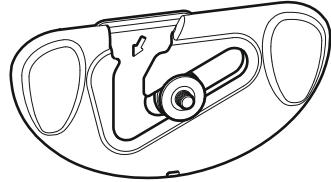

ATTENTION à la capacité : 121lbs (55kg). Une utilisation avec des produits plus lourds que la capacité indiquée peut entraîner une instabilité et causer des blessures.

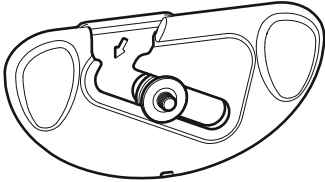

Lisez toutes les instructions avant de débuter l'installation.

Si vous avez des questions sur ce produit ou sur son installation, contactez le service d'assistance clientèle avant de renvoyer le produit au magasin. Rendez vous sur www.avfgroup.com/unimax pour accéder à la vidéo concernant l'installation.

NUMÉRO DE L'ASSISTANCE CLIENT:
+44 (0)1952 670009 (UK)
1-800 667 0808 (USA)



AVF Group Ltd. Hortonwood 30, Telford, Shropshire, TF1 7YE, England
AVF Incorporated 3187, Cornerstone Drive, Eastvale, CA 91752, USA

www.avfgroup.com

Vue d'ensemble de l'assemblage

Placez les crochets de fixation sur le téléviseur

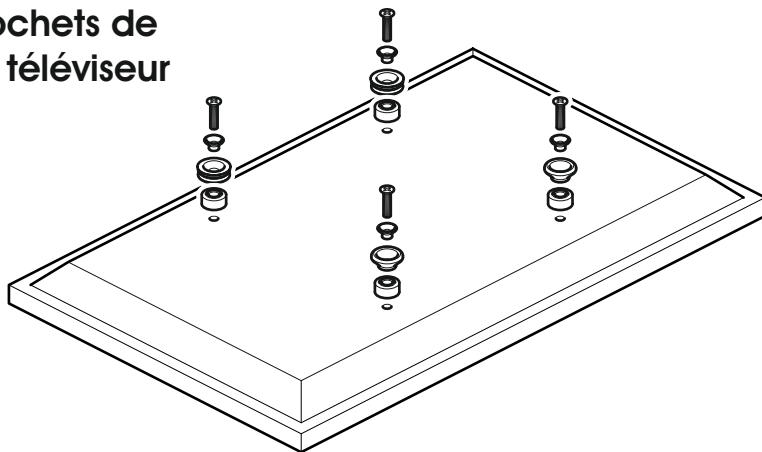

Installer le support mural

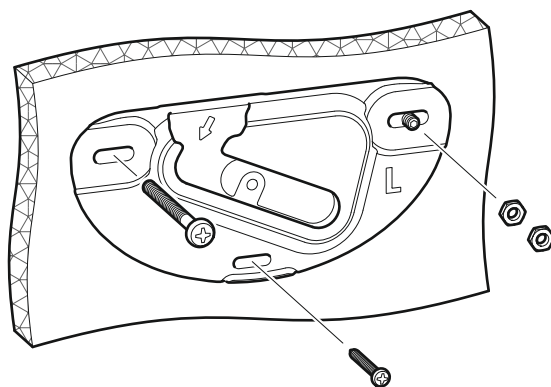

Accrocher le téléviseur

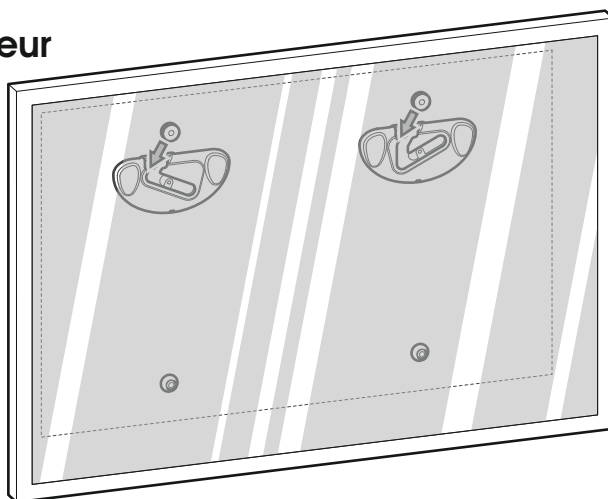

Index

- 1** Mesurer la profondeur et la taille des trous de fixation
- 2** Placez les crochets de fixation sur le téléviseur
- 3** Assemblez le modèle de positionnement
- 4** Déterminez les trous des crochets
- 5** Marquage des trous de forage dans le mur
- 6** Installer l'applique murale
- 7** Installation des couvercles des supports muraux
- 8** Accrochez le téléviseur

Conserver les emballages si l'applique a besoin d'être ramenée.

Les contenus peuvent varier de la photographie/illustrations.

Vous n'aurez pas besoin de toutes ces pièces, attendez-vous donc à ce qu'il reste des pièces selon les caractéristiques de votre téléviseur.

Ce produit est à utiliser à l'intérieur uniquement. Utiliser ce produit à l'extérieur causera des défaillances et de possibles accidents.

Il est de la responsabilité de l'installateur de s'assurer que les murs soient aux critères requis et vides de tout câblage (ex : gaz, électricité, eau etc....)

AVF n'acceptera aucune responsabilité pour tout dommage ou perte causée par l'installation du produit dans un mur en deçà de ces critères.

Outils recommandés

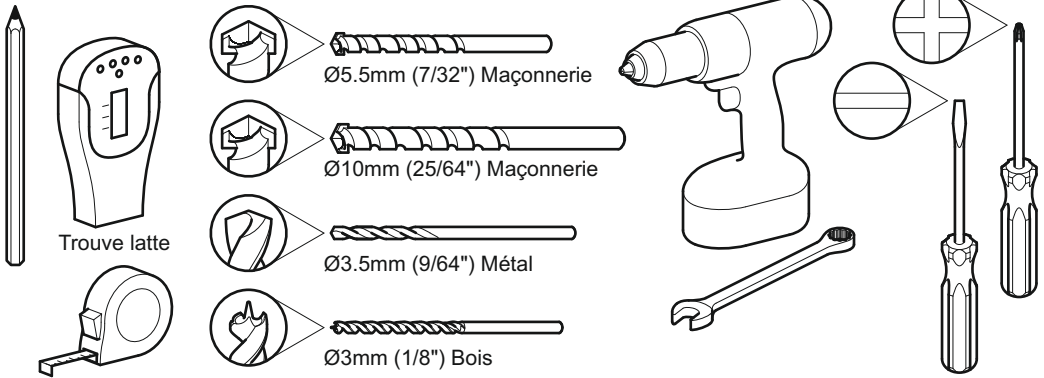

Pièces emballées

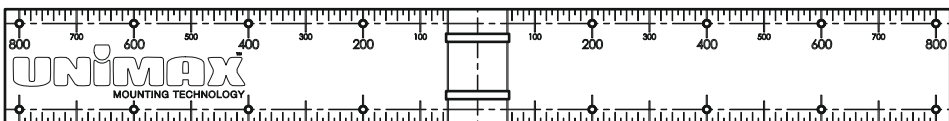
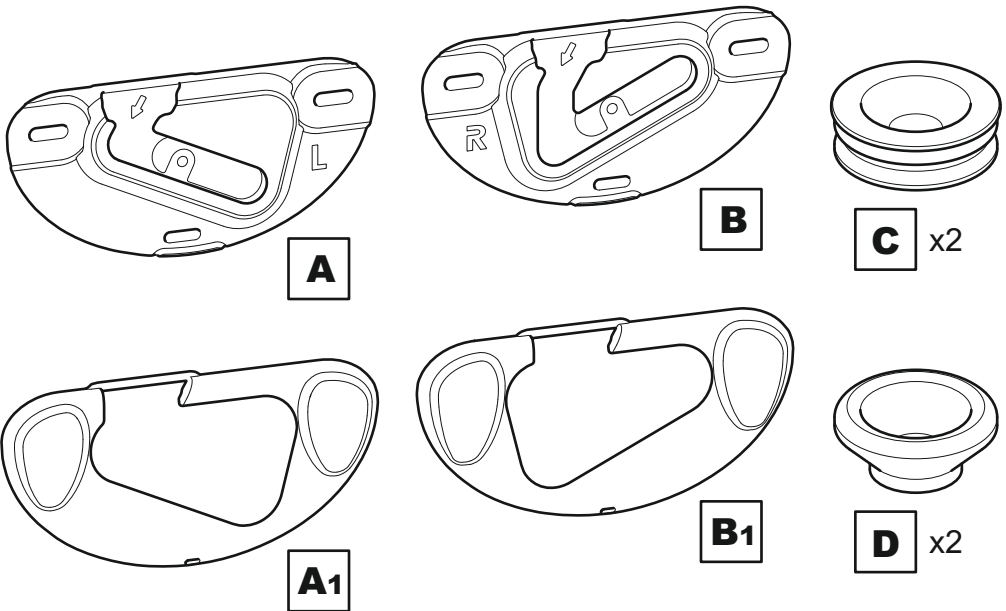

U1

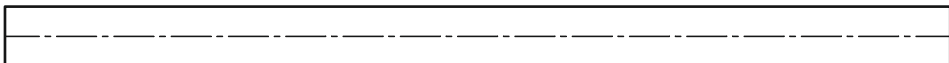

U2

Vis TV, réducteurs et séparateurs

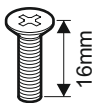

G1 x4

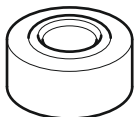

E1 x12

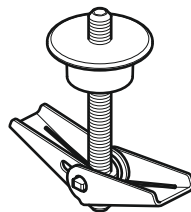

H x4



J x8

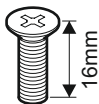

G4 x4

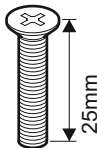

G5 x4

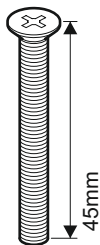

G6 x4

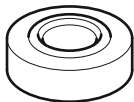

E2 x4

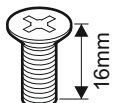

G7 x4

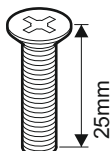

G8 x4

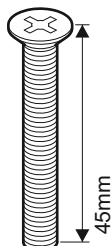

G9 x4



F1 x4

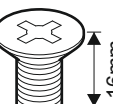

G10 x4

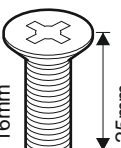

G11 x4

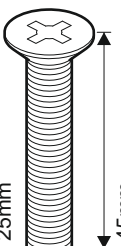

G12 x4



F2 x4



F3 x4



L x2



M x4

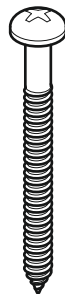

N x4



O x2



P x2



R



S



Q x2

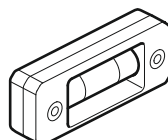

T

Retirez les couvercles des consoles murales et gardez-les pour les étapes 7

Les couvercles de consoles murales **A1** et **B1** s'enlèvent de la même façon.

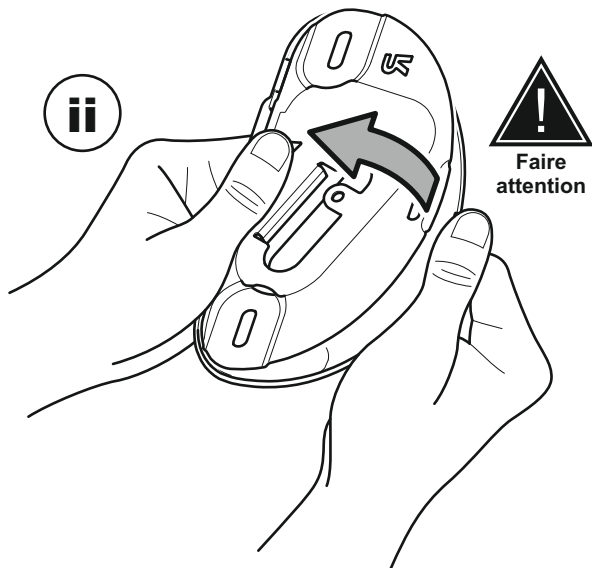
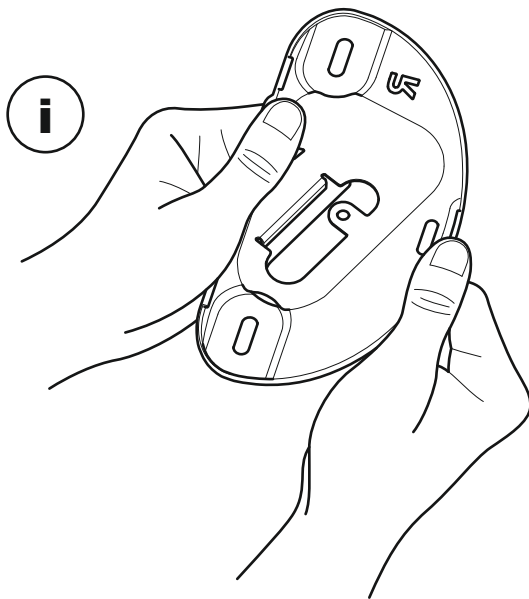

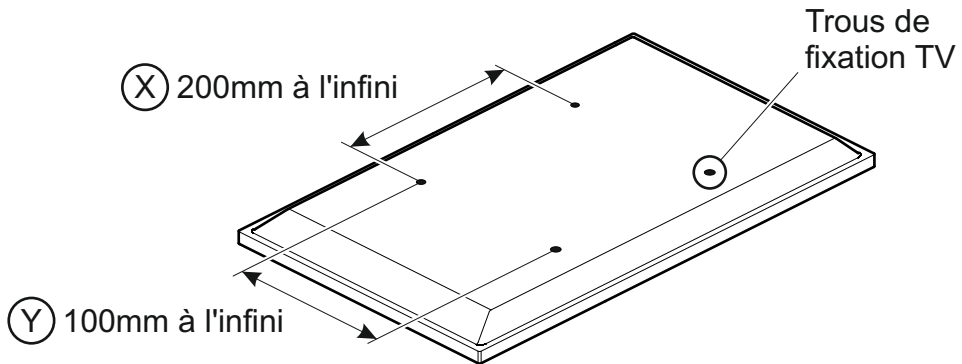

1 Mesurer la profondeur et la taille des trous de fixation

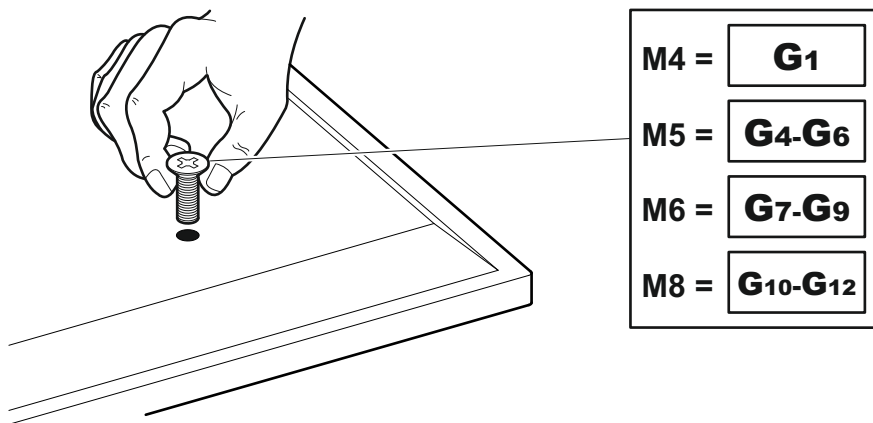

 Si la largeur de (X) est inférieure à 200 mm ou que la hauteur de (Y) est inférieure à 100 mm **CESSEZ** l'installation immédiatement et communiquez avec la ligne d'assistance à la clientèle

4 diamètres de vis TV vous sont fournis, **M4**, **M5**, **M6**, et **M8**. Déterminez le diamètre de la vis qui convient et mémorisez- le pour l'étape 2.



 Après avoir complété l'étape 2 il vous restera des pièces d'assemblage, conservez- les.

2

Placez les crochets de fixation sur le téléviseur

Une fois que vous aurez trouvé le diamètre de la vis appropriée aux besoins de votre téléviseur, vous devrez choisir l'espaceur mural nécessaire. Regardez derrière votre téléviseur, puis choisissez L'OPTION qui convient à votre téléviseur. Voir le verso de la page pour de plus amples renseignements.

OPTION 1

12mm Espacement

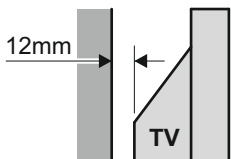

Convient aux téléviseurs avec un dos plat et aucune obstruction

OPTION 2

20mm Espacement

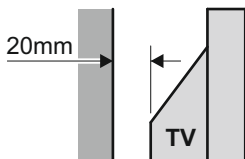

Convient aux téléviseurs avec des obstructions petites à moyennes, comme le bloc d'alimentation, les moulures, etc.

OPTION 3

40mm Espacement

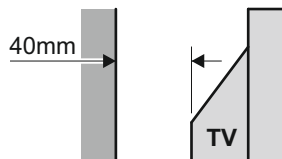

Convient aux téléviseurs avec de grandes obstructions comme le bloc d'alimentation, les moulures, etc.

Fixations supérieures

Fixations inférieures

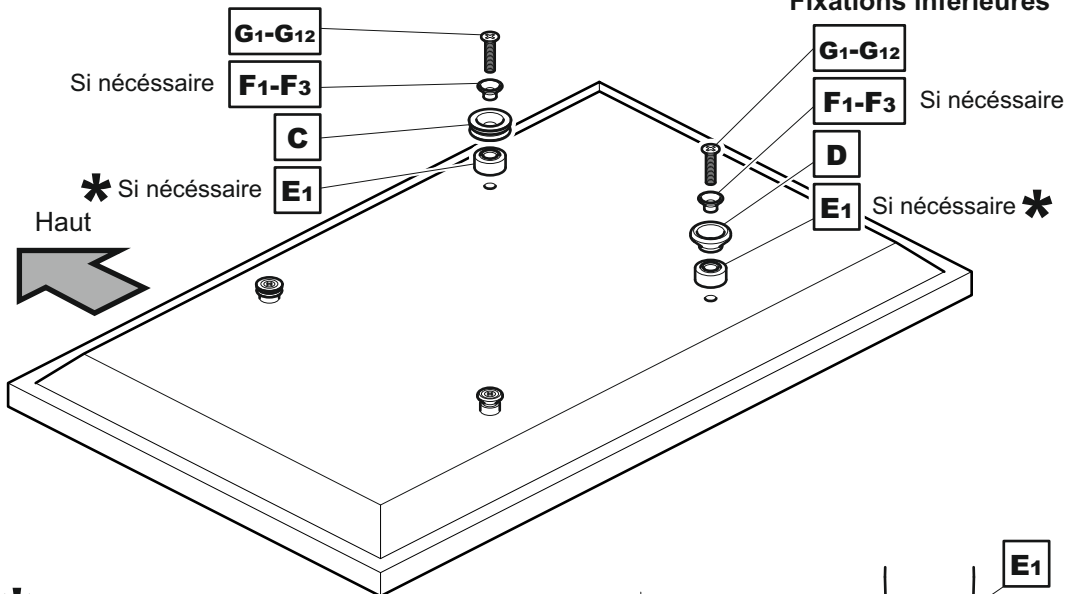

Dans certaines circonstances il peut être nécessaire d'utiliser les écarteurs rouges **E2** pour remplacer ou compléter l'écarteur **E1**.

Quand est-il nécessaire d'utiliser les écarteurs rouges **E2**?

Il est conseillé que lorsque vous fixez les accroche **C** et cales **D** à votre TV vous ayez au moins 5 à 10mm d'engagement de la vis. Dans certaine circonstances vous pouvez avoir besoin d'utiliser les écarteurs rouge **E2** en remplacement ou en complément des écarteurs **E1** pour y parvenir. Si vous utilisez les écarteurs rouges **E2** vous devez utiliser les 4.

Problème
Vis pas assez insérer

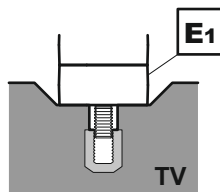



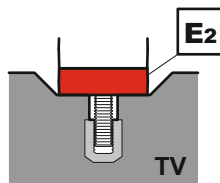







Solution
L'écarteur rouge **E2** a remplacé l'écarteur **E1**













OPTION 1
12mm Espacement

Fixations supérieures

M4	M5	M6	M8
 G1	 G4	 G7	 G10
 F1	 F2	 F3	
 C	 C	 C	 C











Fixations inférieures

M4	M5	M6	M8
 G1	 G4	 G7	 G10
 F1	 F2	 F3	
 D	 D	 D	 D











OPTION 2
20mm Espacement

Cette OPTION ne convient pas aux vis M4 de G1

Fixations supérieures

M5	M6	M8
 G5	 G8	 G11
 F2	 F3	
 C	 C	 C
 E1	 E1	 E1











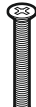
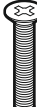



Fixations inférieures

M5	M6	M8
 G5	 G8	 G11
 F2	 F3	
 D	 D	 D
 E1	 E1	 E1













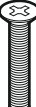



OPTION 3
40mm Espacement

Cette OPTION ne convient pas aux vis M4 de G1

Fixations supérieures

M5	M6	M8
 G6	 G9	 G12
 F2	 F3	
 C	 C	 C
 E1	 E1	 E1
 E1	 E1	 E1
 E1	 E1	 E1

Fixations inférieures

M5	M6	M8
 G6	 G9	 G12
 F2	 F3	
 D	 D	 D
 E1	 E1	 E1
 E1	 E1	 E1
 E1	 E1	 E1

3 Assemblez le modèle de positionnement

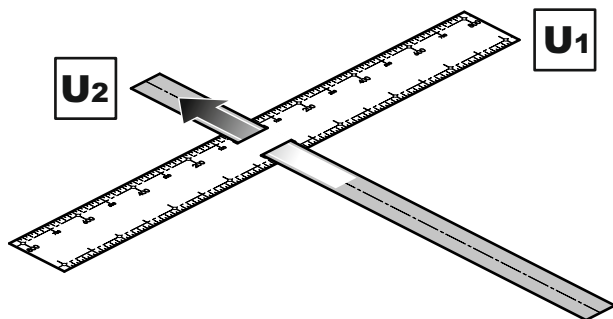

4 Déterminez les trous des crochets

Placez le modèle à l'arrière du téléviseur et suivez les instructions ci-dessous.

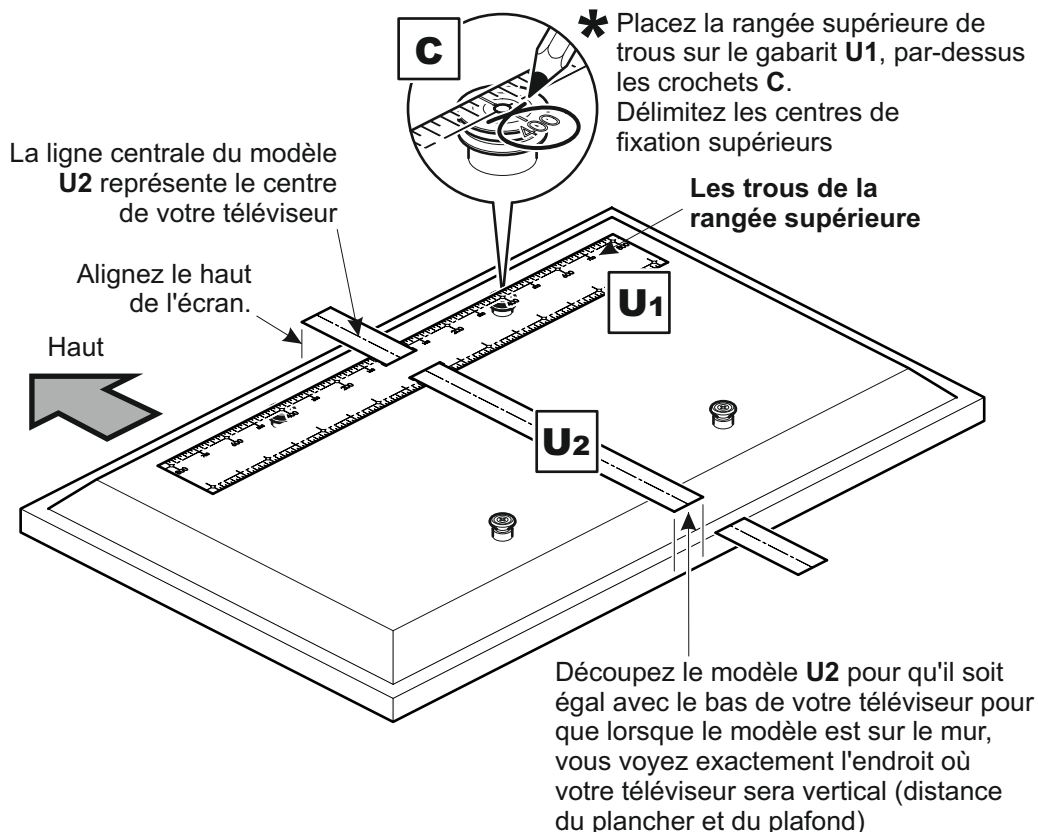

* Si les crochets **C** ne sont alignés avec aucun des trous du gabarit, alors assurez-vous que ce dernier est bien en place, puis poinçonnez 2 trous avec un crayon ou un objet pointu de sorte qu'ils correspondent avec les centres de fixation supérieurs.

5

Marquage des trous de forage dans le mur

Avant de marquer le mur, déterminez le type du mur (mur solide/placoplâtre/bois boulonné/colombage métallique).

Assurez-vous que la région de perçage est libre de services principaux (essence/électricité/eau).

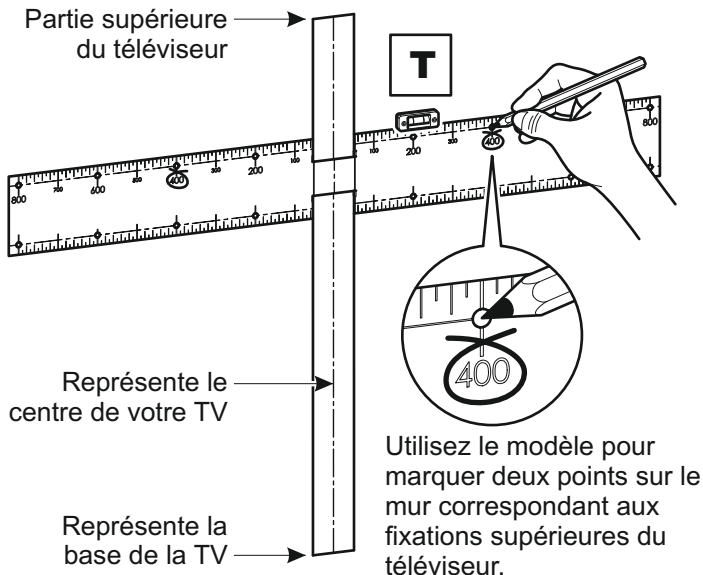

Ensuite, utilisez les consoles murales **A** et **B** comme modèles, puis placez-les sur les **MARQUES DE CRAYON** appropriées que vous avez tracées, de façon à ce que la marque se trouve au milieu du **TROU CENTRAL** de la console murale. Assurez-vous que la console est à niveau et marquez trois **POINTS DE PERÇAGE** à l'aide d'un crayon. Recommencez pour l'autre console. Recommencez pour l'autre console. Percez six trous pilotes de 3 mm, puis sélectionnez les fixations appropriées (voir la section 6).

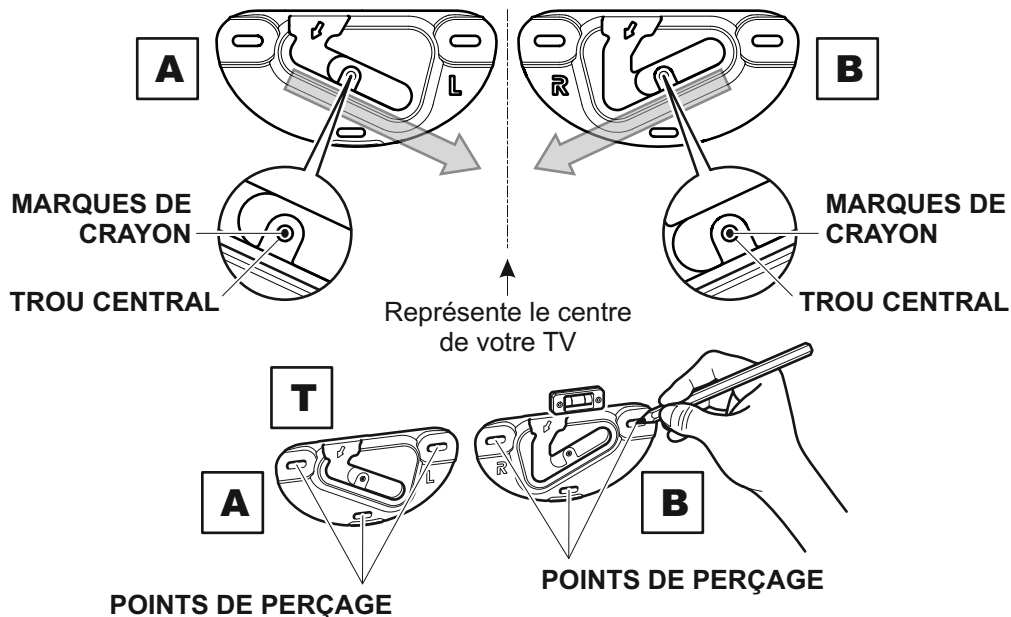

6 Installer l'applique murale

Utilisez les fixations adaptées à votre type de mur. Il sera peut-être nécessaire d'utiliser plusieurs types de fixations pour les installations couvrant différents types de murs.
NE SERREZ PAS EXCESSIVEMENT LES VIS.

Mur Solide

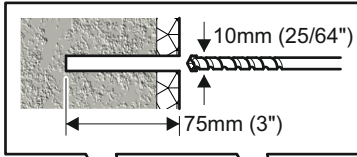

Enlevez la poussière du trou



Retirer la poussière du trou

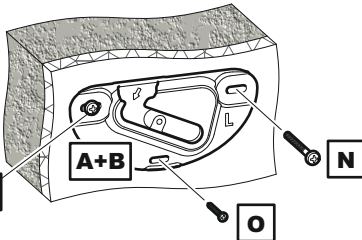
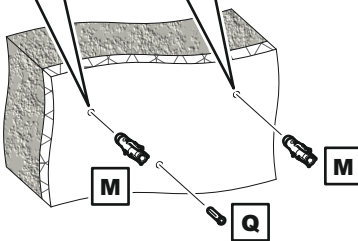
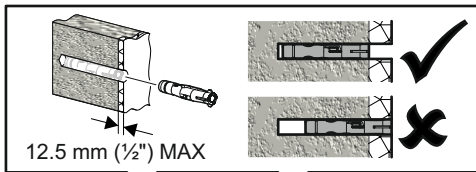
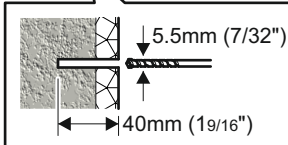

Lubrifiez le pas de vis avec du savon

Placoplâtre

Caractéristiques de surface de soutien mini:
 - Placoplâtre de 1/2" d'épaisseur, montées sur des ossatures bois de 1/2" x 3 1/2" éloignées d'au moins 16".

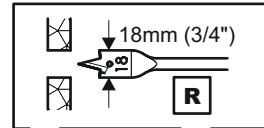

* 40mm (1 9/16") Espace Minimum



Retirer la poussière du trou

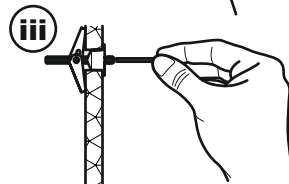
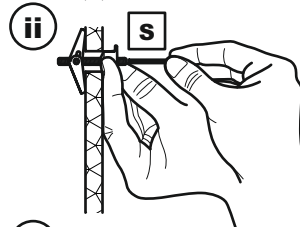
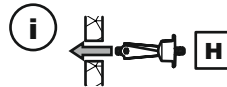

Vissez à fond, sans excès

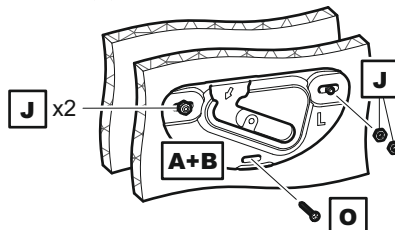

Montant en Bois

Caractéristiques de surface de soutien mini:

- Placoplâtre de 1/2" d'épaisseur

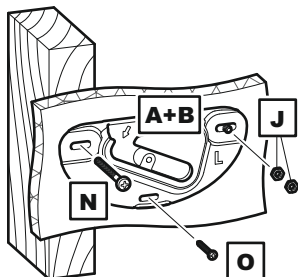
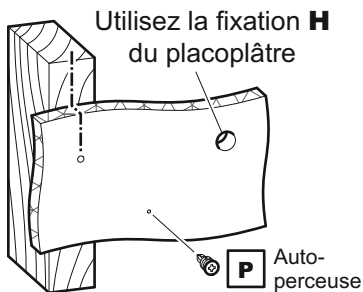
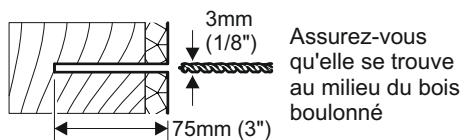
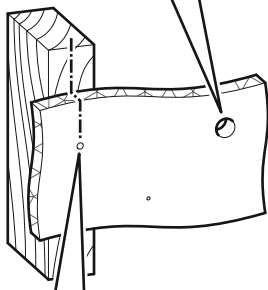
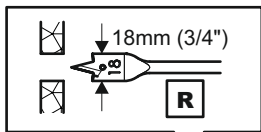

Lubrifiez la vis avec du savon

Une seule fixation sur le montant en bois.
Les autres dans le placoplâtre (voir ci-dessus).

Montant en Métal

Caractéristiques de surface de soutien mini:

- Placoplâtre de 1/2" d'épaisseur

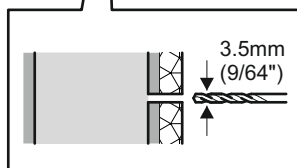
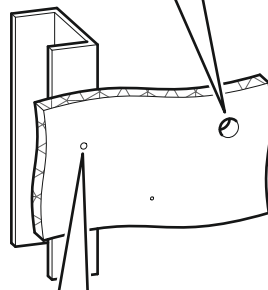
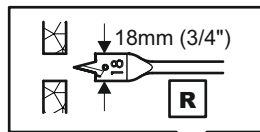

0.6mm (0.025") MIN

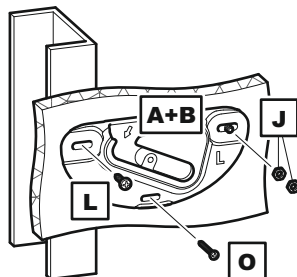
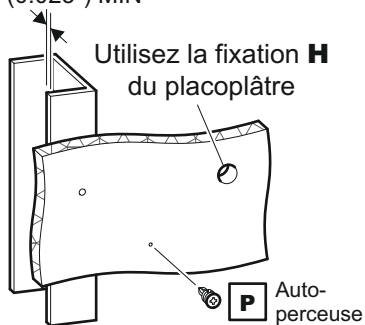

Une seule fixation dans le montant en métal.
Les autres dans le placoplâtre (voir ci-dessus).

7

Installation des couvercles des supports muraux

Sur les couvercles de consoles murales **A1** et **B1** se trouvent 3 pattes de retenues. Elles se trouvent sur 3 lèvres de retenues de la console murale **A** et **B**, puis verrouiller les couvercles de consoles murales en place.

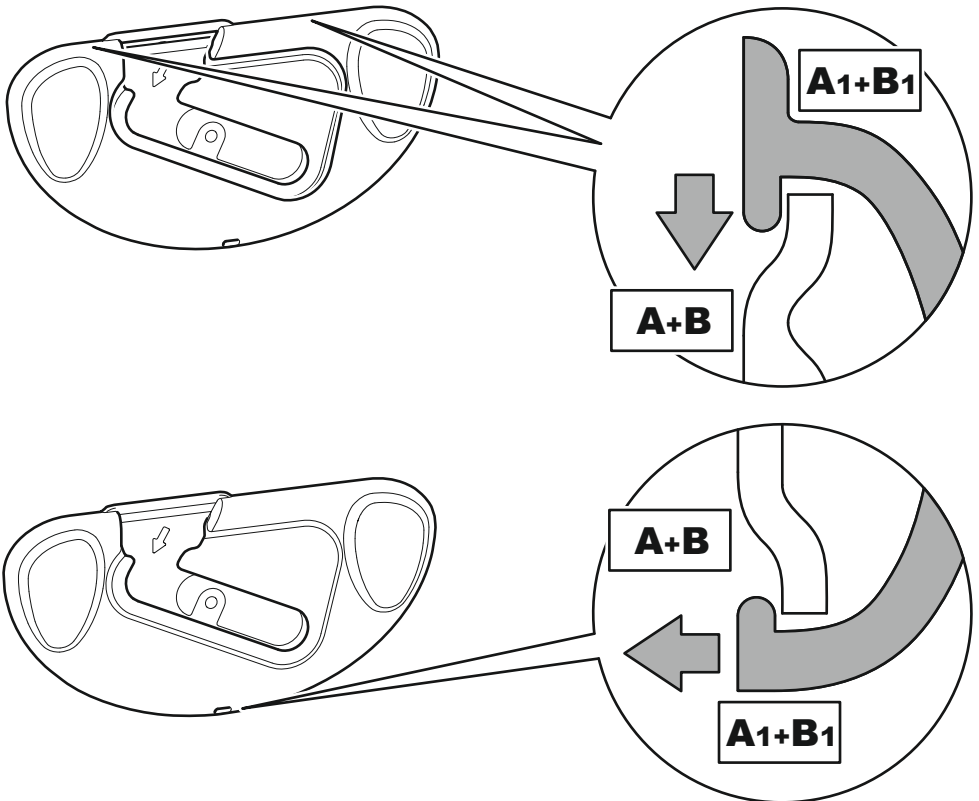
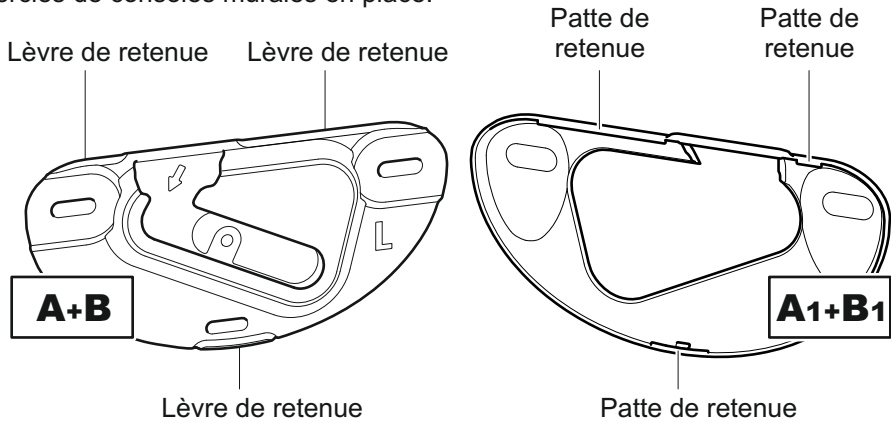

8 Accrochez le téléviseur

Deux personnes sont nécessaires pour mettre en place le téléviseur.

Alignez les crochets **C** (à l'arrière du téléviseur) avec l'ouverture des fixations **A** & **B**. Faites glisser votre TV vers le bas des rails de guidage. Assurez-vous que les 2 accroches soient totalement engagées. Si les câbles à l'arrière de l'écran empêchent la TV de reposer verticalement contre le mur, la configuration alternative des accroches est nécessaire. (voir la section 2).

La TV doit toujours être parallèle au mur. Utilisez des entretoises/douilles-entretoises autosertissables comme indiqué dans la section 2.

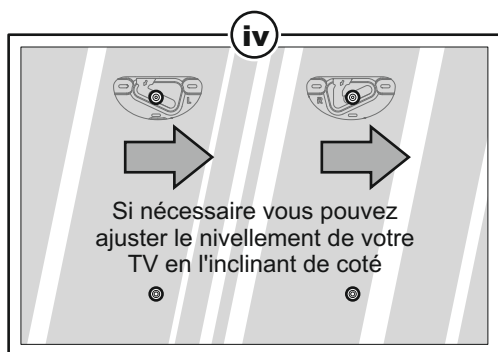
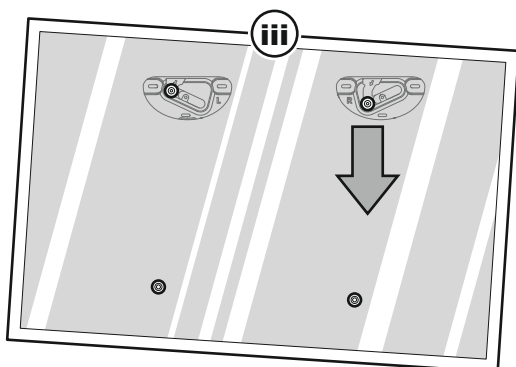
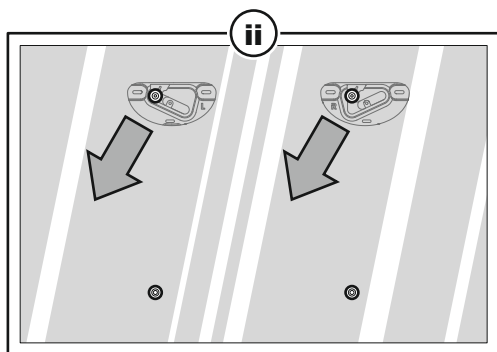
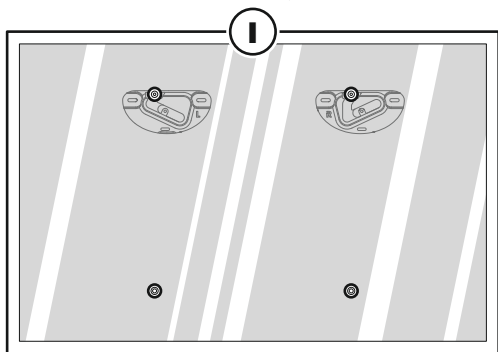
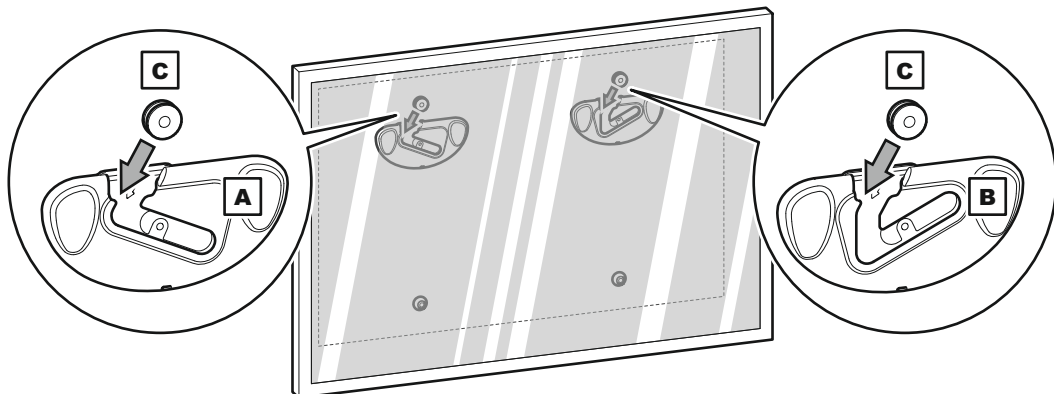

Pour libérer la TV

C'est un travail qui nécessite 2 personnes. Pour libérer la TV du support, inverser les mouvements comme décrit ci-dessus

Pour déclipser la plaque supérieure du support

Si vous souhaitez enlever les couvercles de la console murale, suivez les étapes ci-dessous

