

JML8451

Leaflet No. 464236 rev00

##

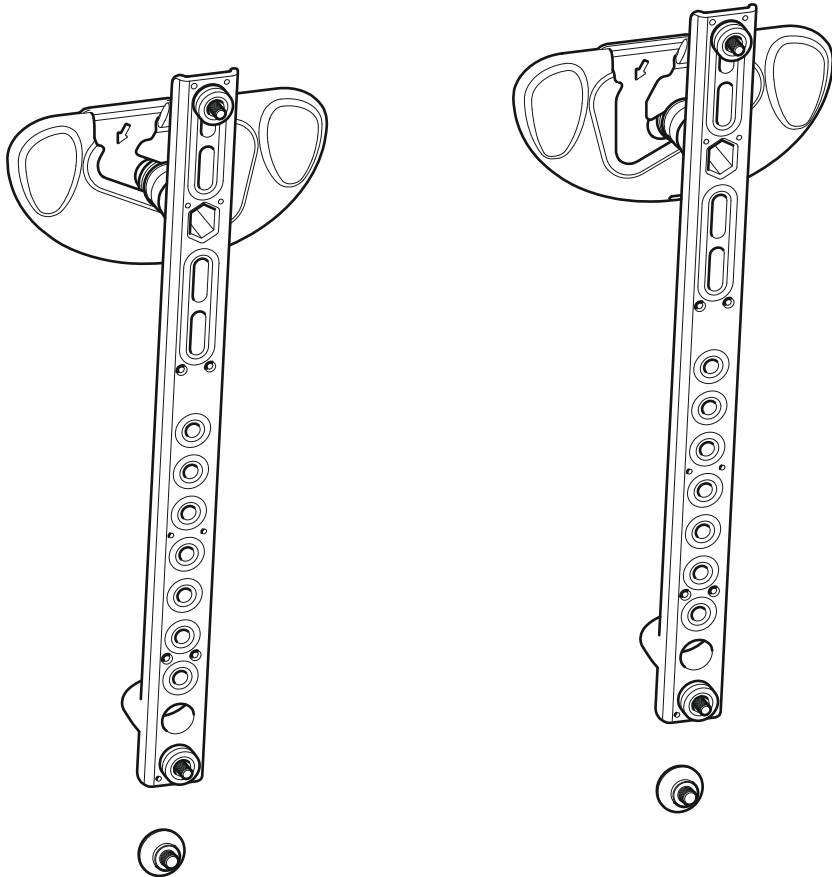

Read through ALL instructions before commencing installation. If you have any questions about this product or issues with installation contact the customer services helpline before returning this product to the store. See jl.avfgroup.com/p/jml8451 for more information.

CUSTOMER SERVICES HELP LINE NUMBER:

01952 670009



121lbs
55kg



80"
203cm

AVF Group Ltd. Hortonwood 30, Telford, Shropshire, TF1 7YE, England

Assembly Overview

Fit Screen Hangers to TV

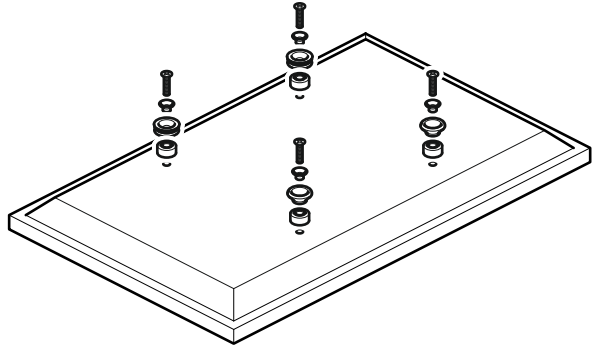

Fitting the Wall Bracket

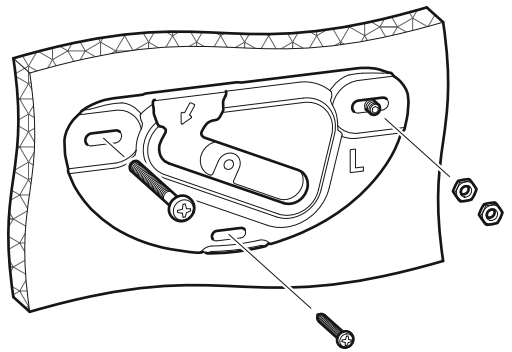

Hanging the TV

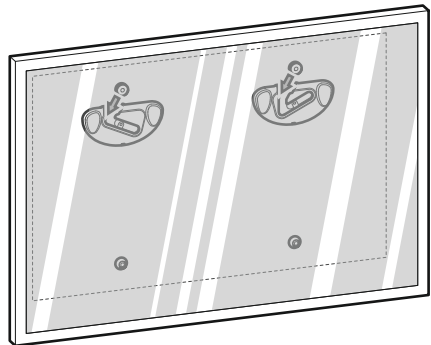

Retain all packaging in case the bracket needs to be returned.

Contents may vary from photography/ Illustrations.

You will not need all these parts, so expect there to be some left over depending upon the specification of your TV.

This product is intended for indoor use only. Use of this product outdoors could lead to failure and personal injury.

It is the responsibility of the installer to ensure that the mounting wall is of a suitable standard and void of any services (eg gas, electricity, water etc).

AVF accept no responsibility for any damage or loss caused by installing this product in a sub standard wall.

Index

1 Measure the TV fixing holes Width and Height

Flat to wall only

2 Fit Screen Hangers to TV

3 Assemble Positioning Template

4 Determine Bracket Hole Centres

5 Marking Wall For Drill Points

6 Fitting the Wall Bracket

7 Fitting the Wall Bracket Covers

8 Hanging the TV

Tilt Position only

9 Choose Tilt

10 Assemble Positioning Template

11 Determine Bracket Hole Centres

12 Fit Tilt Brackets to TV

13 Marking Wall For Drill Points

14 Fitting the Wall Bracket

15 Fitting the Wall Bracket Covers

16 Hanging the TV

Tools Recommended

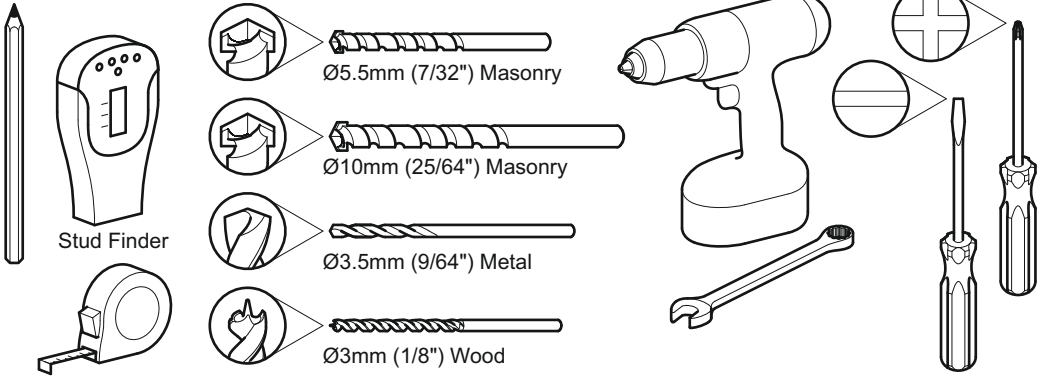

Boxed Parts

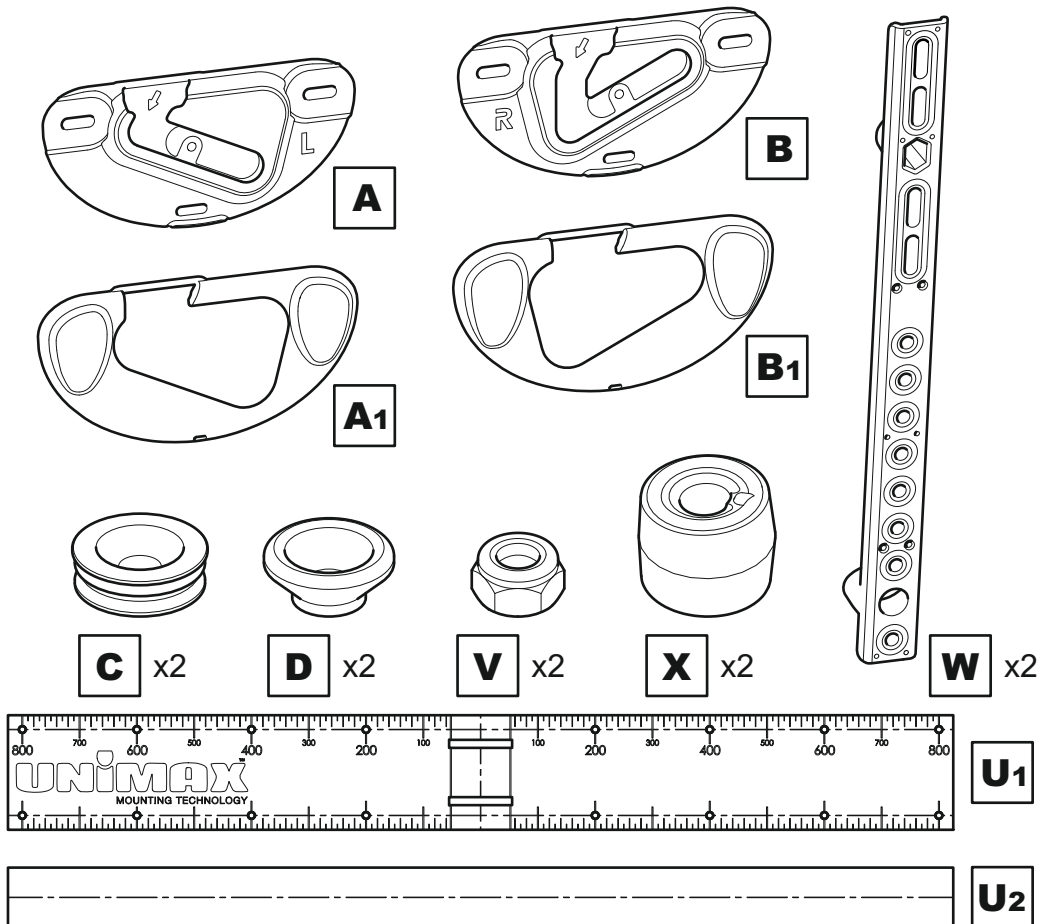

TV Screws, Reducers and Spacers

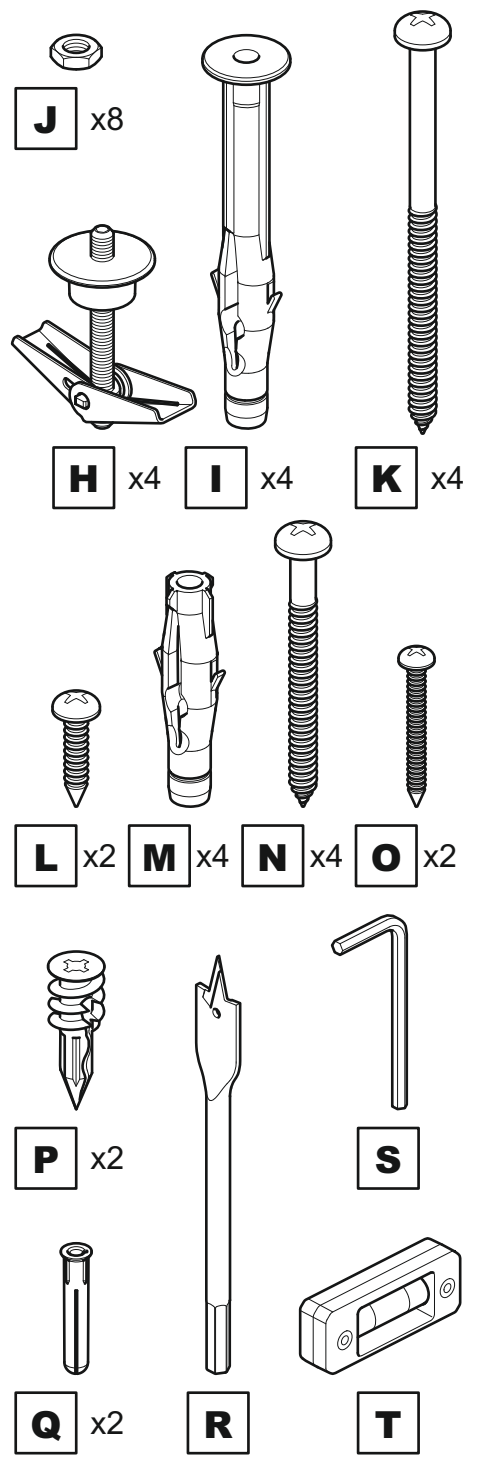
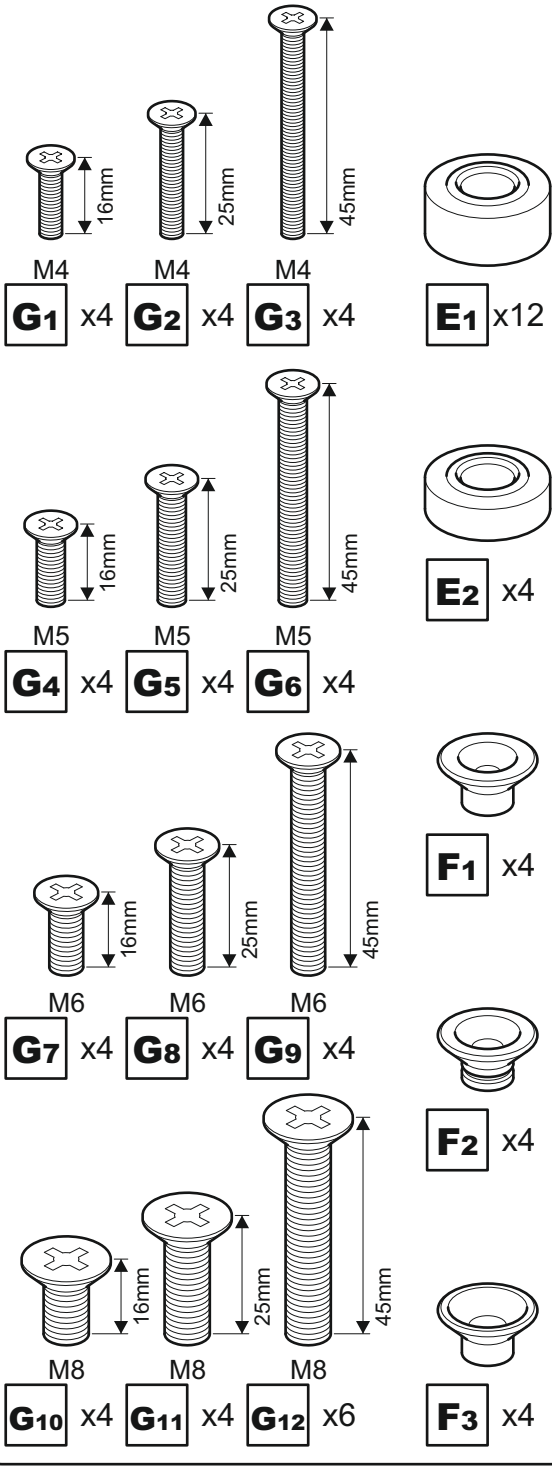

Remove the Wall Bracket Covers and keep for step 7 or 15

Wall bracket covers **A1** & **B1** are removed in the same way.

i



ii

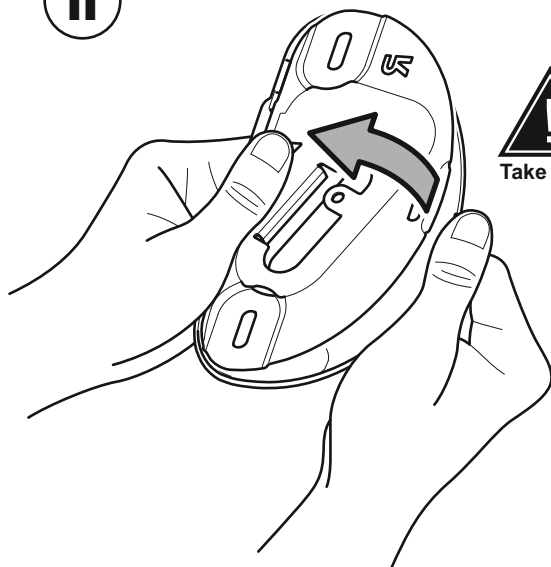

Take Care

1 Measure the TV fixing holes Width and Height

Flat (X) 200mm to infinity

Tilt (X) 200mm to infinity

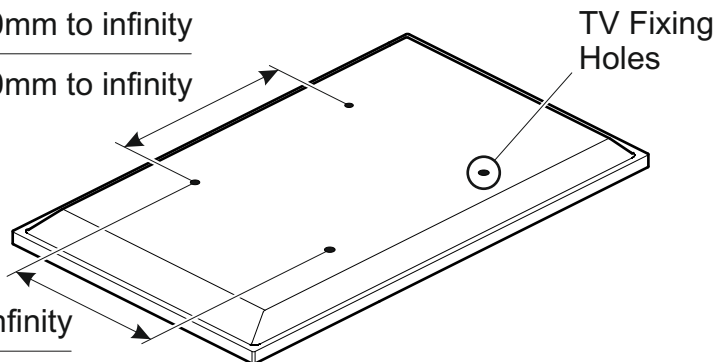

Flat (Y) 100mm to infinity

Tilt (Y) 100mm to 400mm

 If width (X) is less than 200mm or height (Y) is less than 100mm STOP installation now and contact the customer help line

You are provided with 4 diameters of TV fixing screws, **M4**, **M5**, **M6** and **M8**. Determine the screw diameter that fits and remember for step 2 or 12.

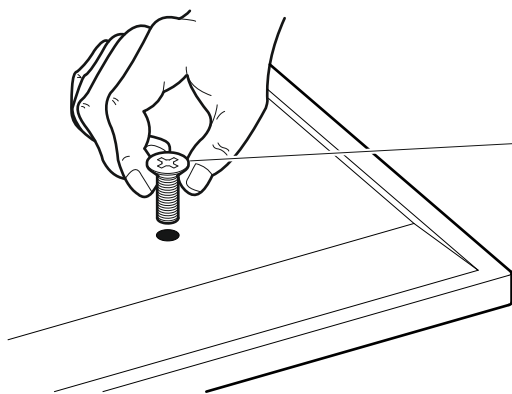

M4 = G1-G3

M5 = G4-G6

M6 = G7-G9

M8 = G10-G12

 After completing step 1 you will have TV fixing screws left over, please keep for future reference

Flat to Wall or Tilt Position

Before you start please choose if you would like your TV to be either Flat to Wall or in a Tilt Position.

Flat to Wall
Follow steps 2 - 8

Tilt Position
Follow steps 9 - 16

2

Fit Screen Hangers to TV

Flat to Wall only

Once you have established which screw diameter you need for your TV you will need to choose which wall spacing you require. Check the back of your TV and use the **OPTION** that fits your TV. Please see page opposite for more details.

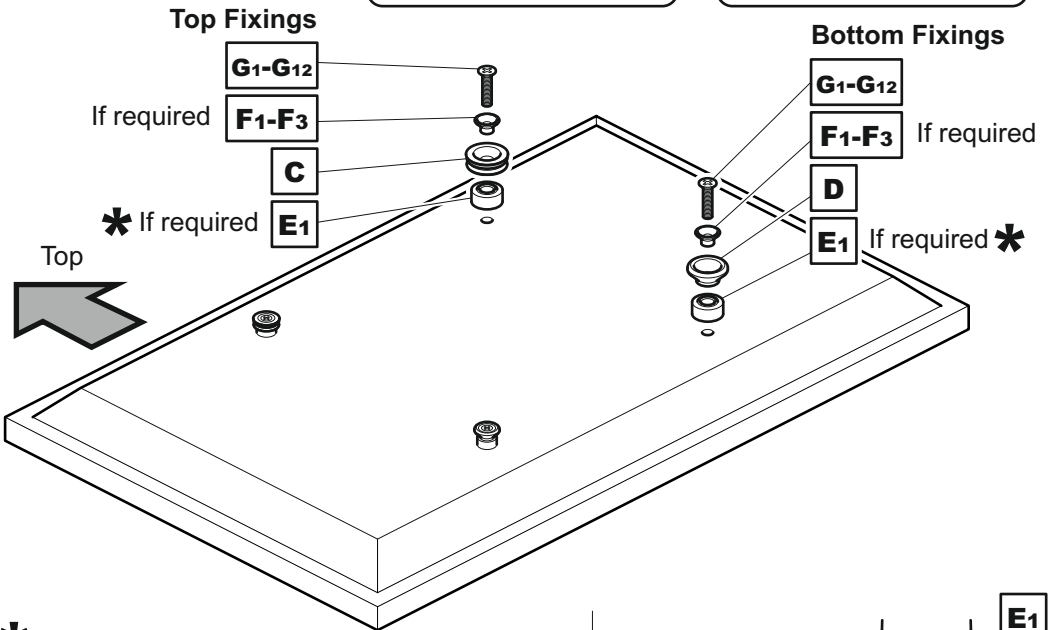
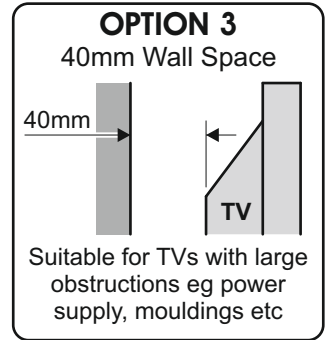
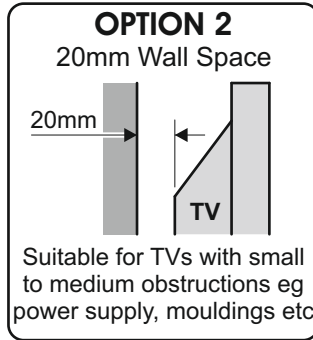
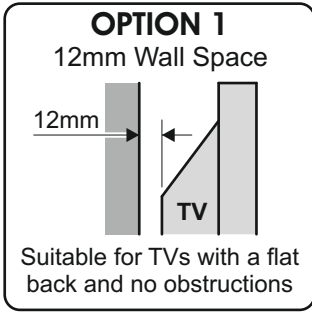

In certain circumstances it may be necessary to use red spacer **E2** as either a replacement or addition to spacer **E1**.

When is it necessary to use red spacers **E2**?

It is recommended that when fitting Hangers **C** and Stand-offs **D** to your TV you have at least 5-10mm of screw engagement. In certain circumstances you may need to use red spacers **E2** as either a replacement, or together with spacers **E1** to achieve this. Whenever you use red spacers **E2** you must use all 4 provided.

Problem
Not enough screw engagement

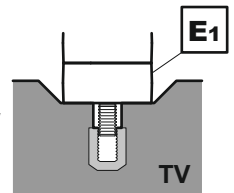



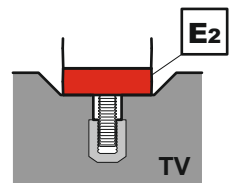







Solution
Red spacer **E2** has replaced spacer **E1**













OPTION 1
12mm Wall Space

Top Fixings















M4	M5	M6	M8
 G1	 G4	 G7	 G10
 F1	 F2	 F3	
 C	 C	 C	 C

Bottom Fixings















M4	M5	M6	M8
 G1	 G4	 G7	 G10
 F1	 F2	 F3	
 D	 D	 D	 D

OPTION 2
20mm Wall Space

Top Fixings























M4	M5	M6	M8
 G2	 G5	 G8	 G11
 F1	 F2	 F3	
 C	 C	 C	 C
 E1	 E1	 E1	 E1

Bottom Fixings























M4	M5	M6	M8
 G2	 G5	 G8	 G11
 F1	 F2	 F3	
 D	 D	 D	 D
 E1	 E1	 E1	 E1

OPTION 3
40mm Wall Space

Top Fixings

M4	M5	M6	M8
 G3	 G6	 G9	 G12
 F1	 F2	 F3	
 C	 C	 C	 C
 E1	 E1	 E1	 E1
 E1	 E1	 E1	 E1
 E1	 E1	 E1	 E1

Bottom Fixings

M4	M5	M6	M8
 G3	 G6	 G9	 G12
 F1	 F2	 F3	
 D	 D	 D	 D
 E1	 E1	 E1	 E1
 E1	 E1	 E1	 E1
 E1	 E1	 E1	 E1

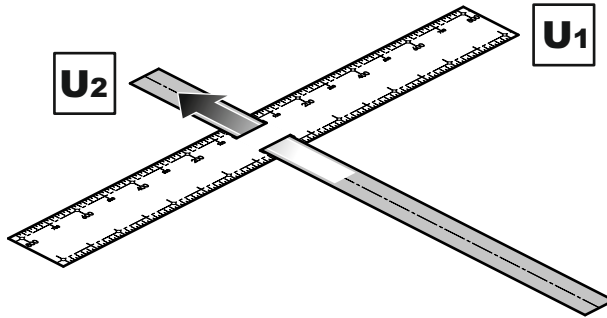
3**Assemble Positioning Template****Flat to Wall only****4****Determine Bracket Hole Centres****Flat to Wall only**

Lay the template on the back of the TV and follow the instructions below.

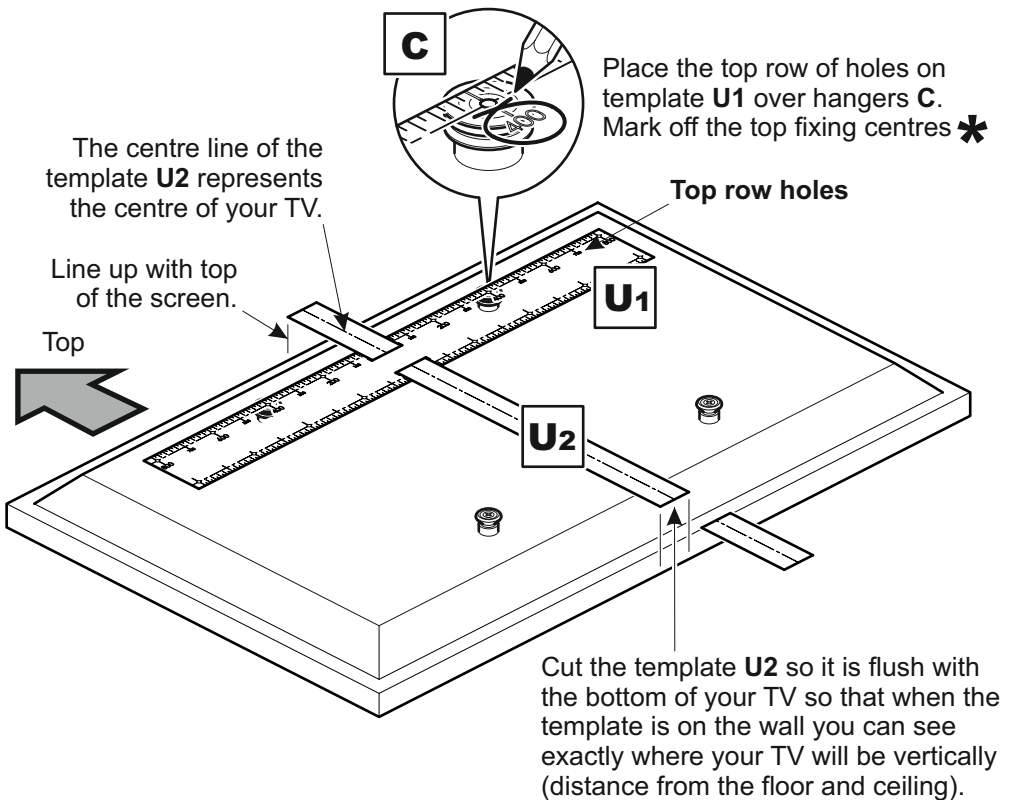

* If hangers **C** do not line up with any holes on the template then ensure template is firmly in position and punch 2 holes to match your top fixing centres with a pencil or sharp object.

5 Marking Wall For Drill Points

Flat to Wall only

Before marking the wall, determine the wall type that you have (i.e. Solid Wall/ Dot & Dab/ Plasterboard/ Wood Stud/Metal Stud). Ensure the drilling area is free from mains services (Gas/Electric/Water).

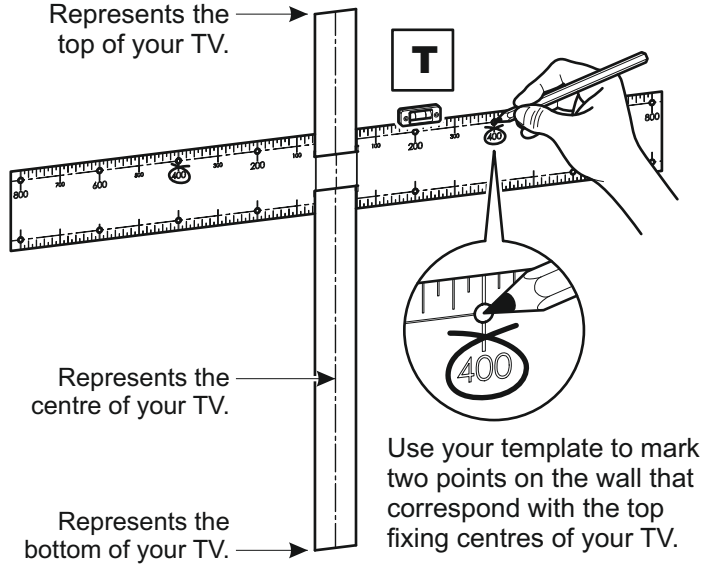

Next, use the Wall Brackets **A** and **B** as a template and position them over the appropriate **PENCIL MARKS** you have made, so that the mark is in the middle of the **CENTRAL HOLE** of the Wall Bracket. Ensure the bracket is level and mark the three **DRILL POINTS** with a pencil. Repeat for other bracket.

Drill six 3mm pilot holes and select appropriate fixings (see section 6)

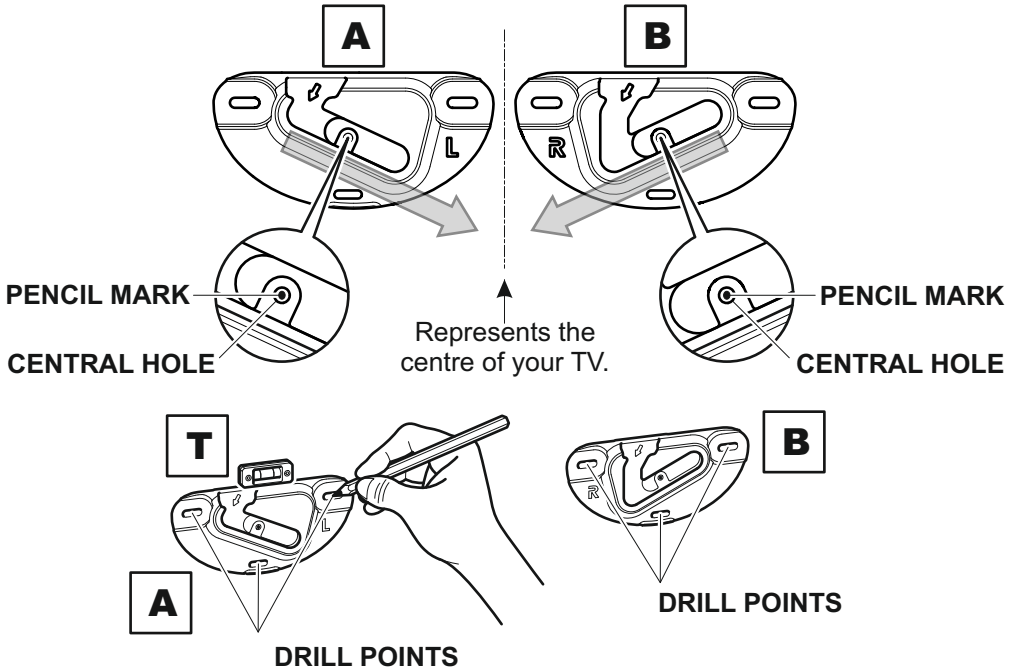

6

Fitting the Wall Bracket

Flat to Wall only

Use the correct fixings for your wall type. Mixing fixing screws may be required for installations that span different wall types. **DO NOT OVER TIGHTEN SCREWS.**

Solid Wall

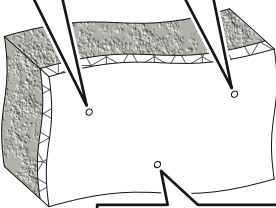
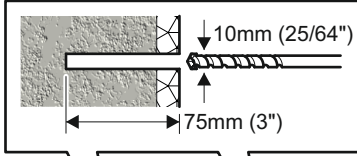

Remove dust from holes

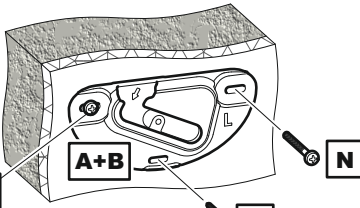
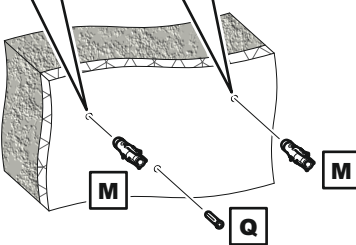
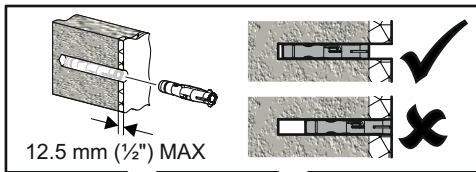
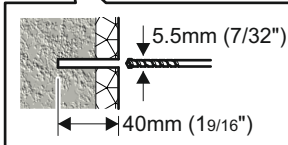

Lubricate screw thread with soap

Dot & Dab

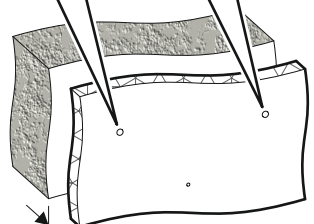
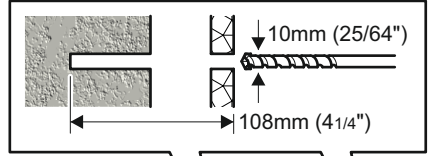

* 40mm (1 9/16") MAX gap

* If gap is above 40mm (1 9/16) use plasterboard fixing method



Remove dust from holes

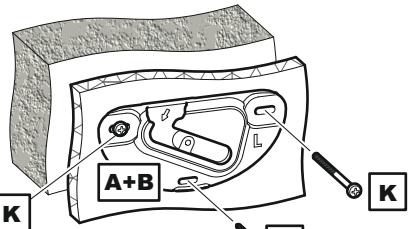
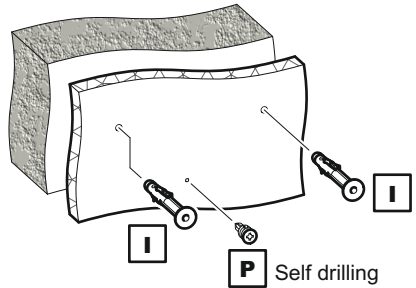

Lubricate screw thread with soap

Plasterboard

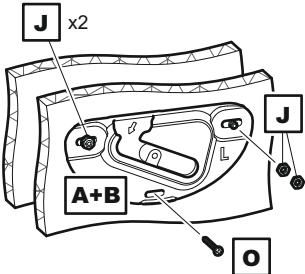
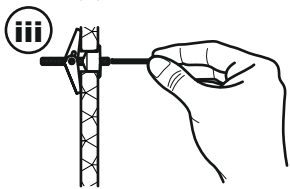
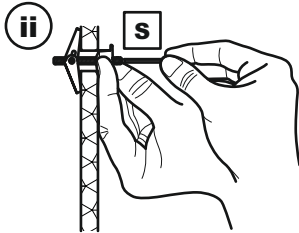
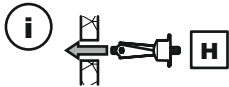
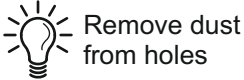
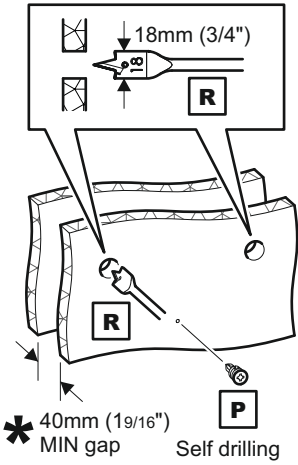

Wood Stud

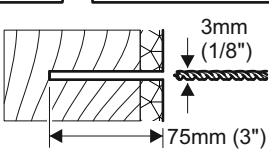
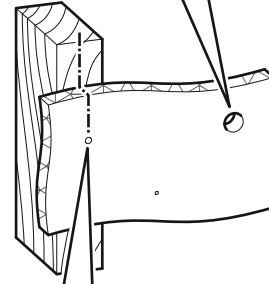
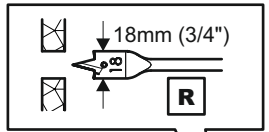

Ensure hole is in the middle of the wood stud

Use Plasterboard Fixing **H**

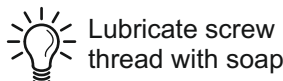
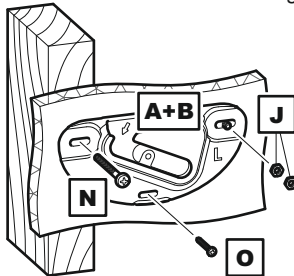
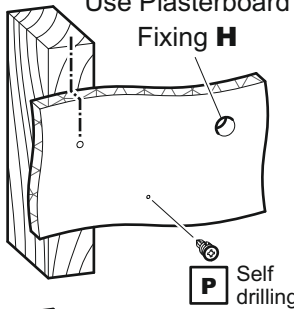

Only one fixing will be in the wood stud. The other fixings will be in plasterboard (see above)

Metal Stud

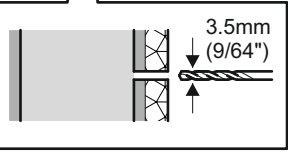
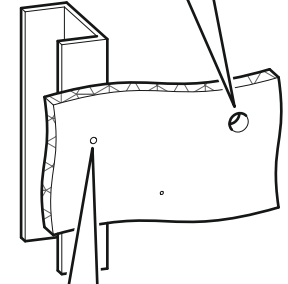
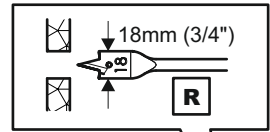

Use Plasterboard Fixing **H**

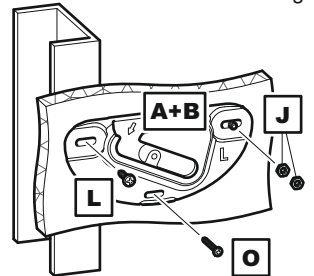
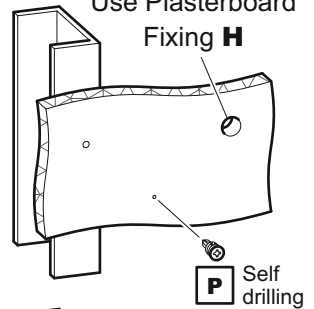

Only one fixing will be in the metal stud. The other fixings will be in plasterboard (see above)

7

Fitting the Wall Bracket Covers

Flat to Wall only

On wall bracket covers **A1** & **B1** are 3 retaining tabs. These locate onto 3 retaining lips on wall brackets **A** & **B** and lock the wall bracket covers in position.

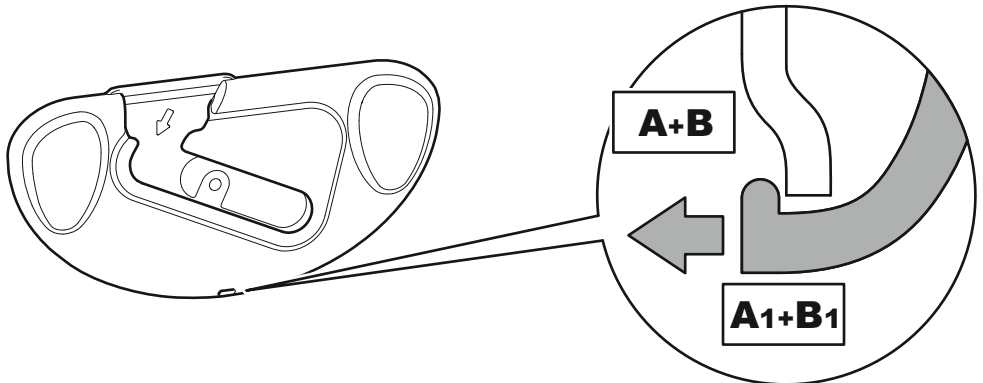
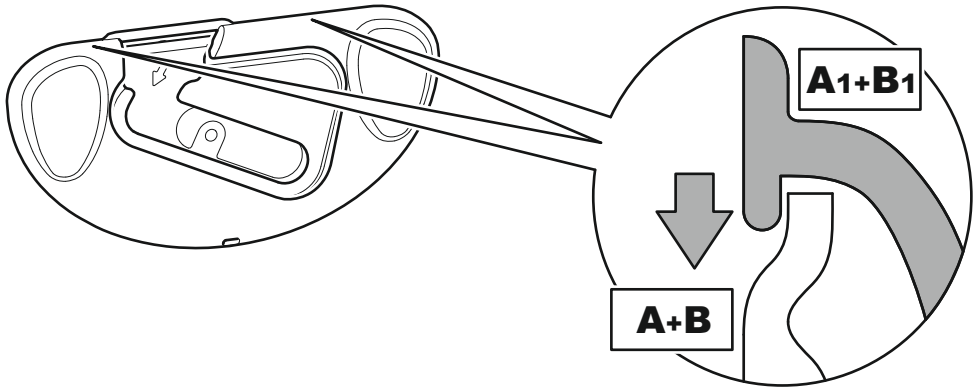
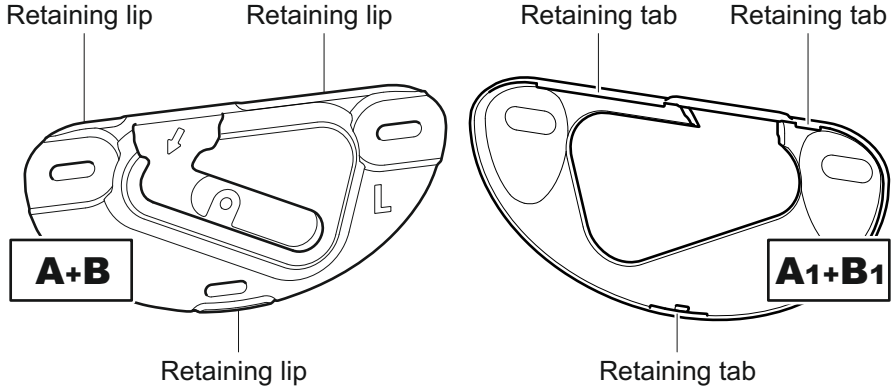

8

Hanging the TV

Flat to Wall only

Hanging the TV is a two person job.

Present hangers **C** (on the back of the TV) to the opening on brackets **A** & **B**. Slide down and across into place. Ensure both hangers are fully engaged. If cables from the TV prevent the TV resting against the wall then an alternative hanger configuration will be required (see section 2).

TV must be parallel to wall. Use spacers / stand-offs as shown in section 2.

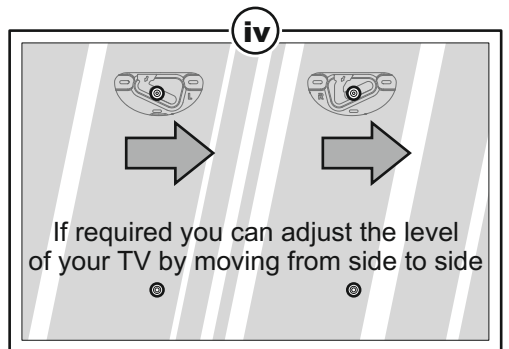
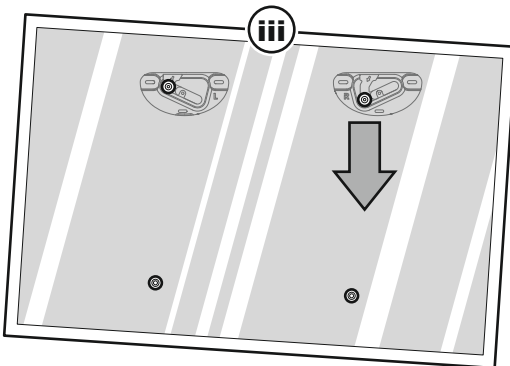
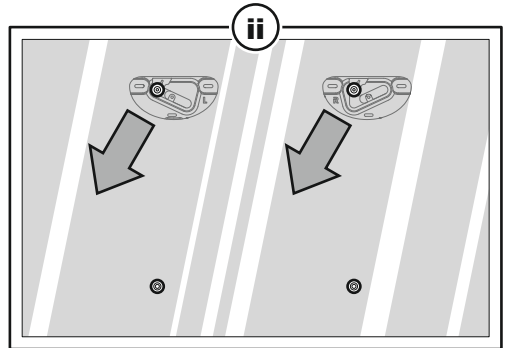
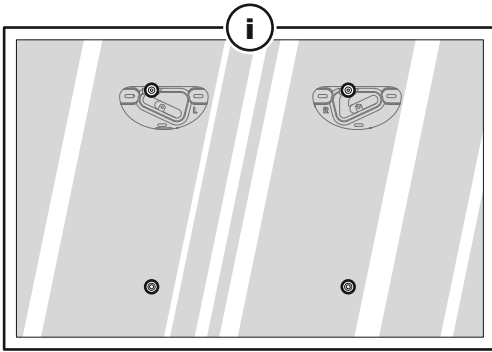
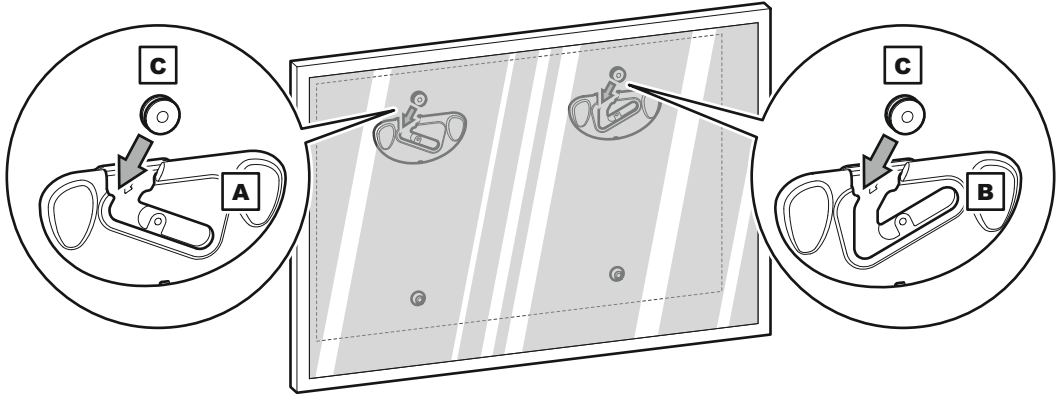

Removing the TV

This is a two person job. To remove the TV reverse the movements as shown above.

9

Choose Tilt

Tilt Position only

You can choose between 2 different tilt positions, either 4° or 8°.

4° tilt

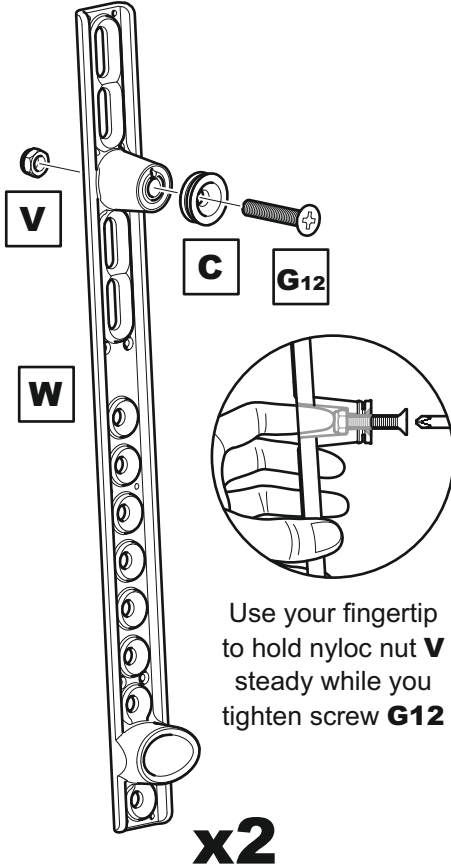

Use your fingertip to hold nyloc nut **V** steady while you tighten screw **G12**

8° tilt

Ensure a flush fit between tilt bracket **W** and spacer **X** by lining up the notch and pip correctly

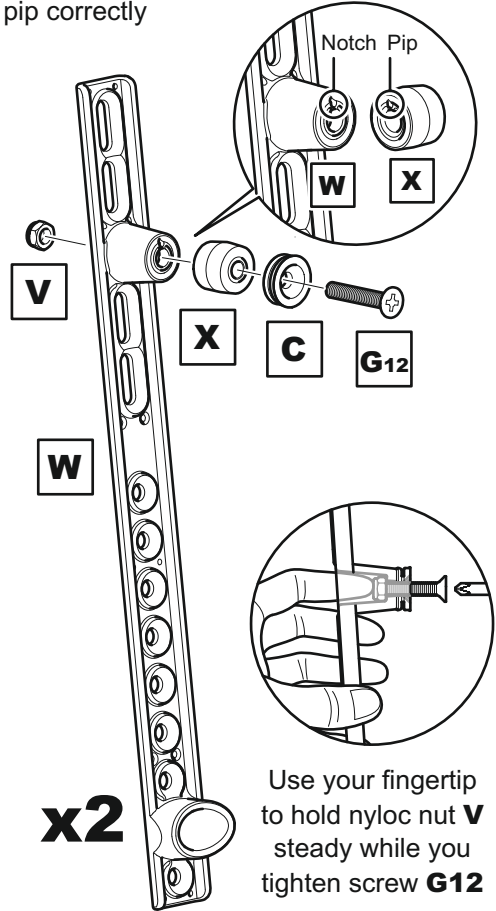

Use your fingertip to hold nyloc nut **V** steady while you tighten screw **G12**

If you have chosen 8° tilt option and your TV size is 65" or over it will be necessary to add spacers to prevent your TV clashing with the wall, the size of your TV will determine if you need to use 1 or 3 spacers. Please see below for an example.

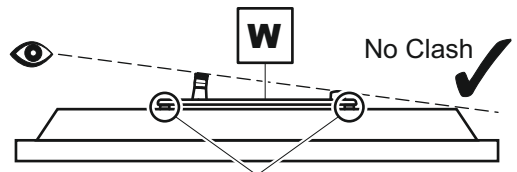
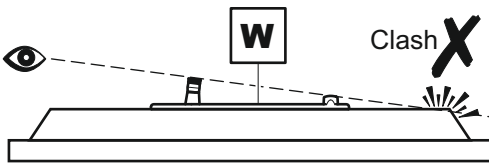

Spacers **E1** are used between tilt bracket **W** and TV to prevent clash with wall

10 Assemble Positioning Template

Tilt Position only

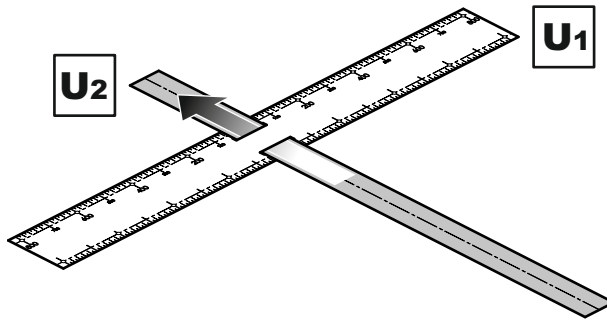

11 Determine Bracket Hole Centres

Tilt Position only

Lay the template on the back of the TV and follow the instructions below.

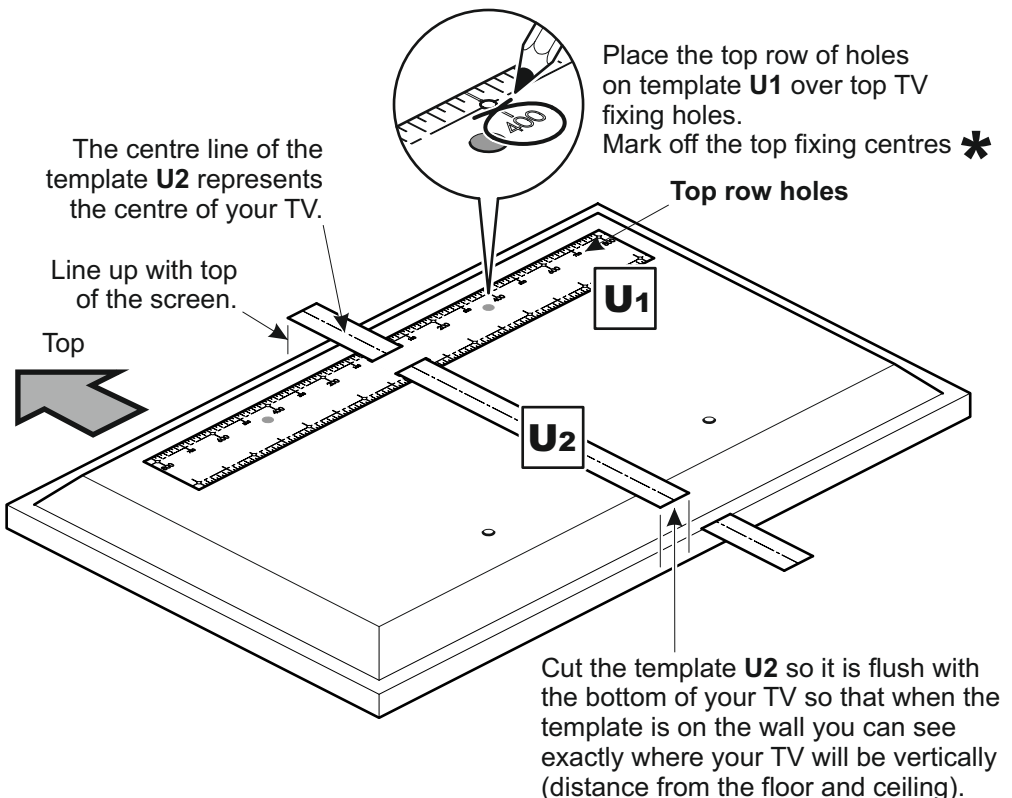

* If top TV fixing holes do not line up with any holes on the template then ensure template is firmly in position and punch 2 holes to match your top fixing centres with a pencil or sharp object.

12 Fit Tilt Brackets to TV

Tilt Position only

Once you have established which screw diameter you need for your TV you will need to choose which wall spacing you require. Check the back of your TV and use the **OPTION** that fits your TV. Please see page opposite for more details.

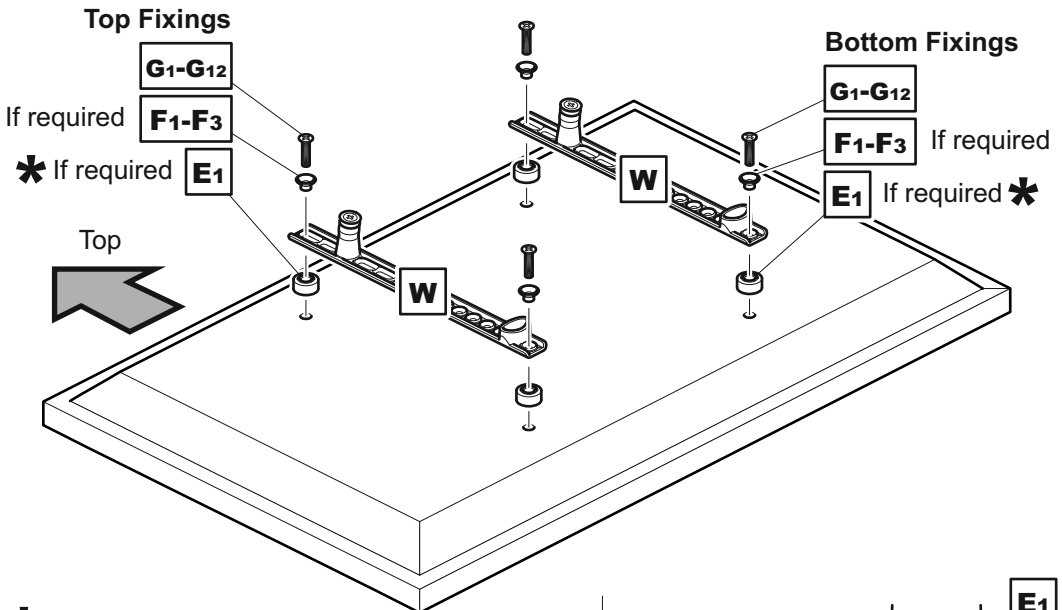
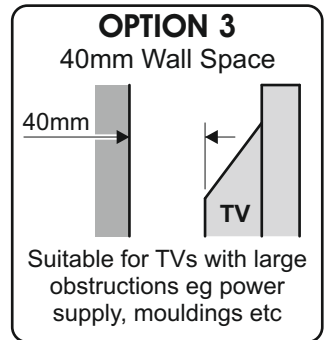
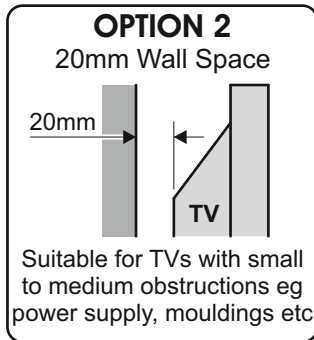
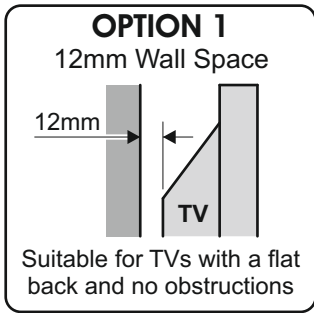

In certain circumstances it may be necessary to use red spacer **E2** as either a replacement or addition to spacer **E1**.

When is it necessary to use red spacers **E2**?

It is recommended that when fitting Tilt Brackets **W** to your TV you have at least 5-10mm of screw engagement. In certain circumstances you may need to use red spacers **E2** as either a replacement, or together with spacers **E1** to achieve this. Whenever you use red spacers **E2** you must use all 4 provided.

Problem
Not enough screw engagement

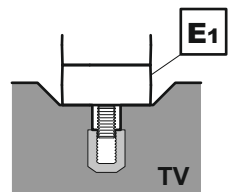

Solution
Red spacer **E2** has replaced spacer **E1**

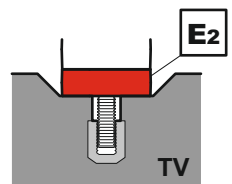

OPTION 1
12mm Wall Space

Top Fixings

Bottom Fixings

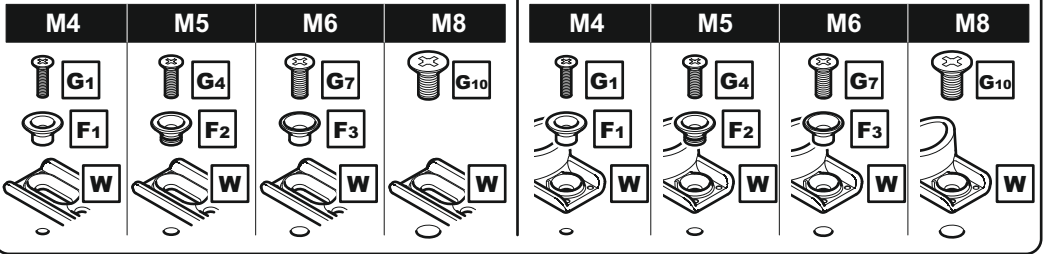

OPTION 2
20mm Wall Space

Top Fixings

Bottom Fixings

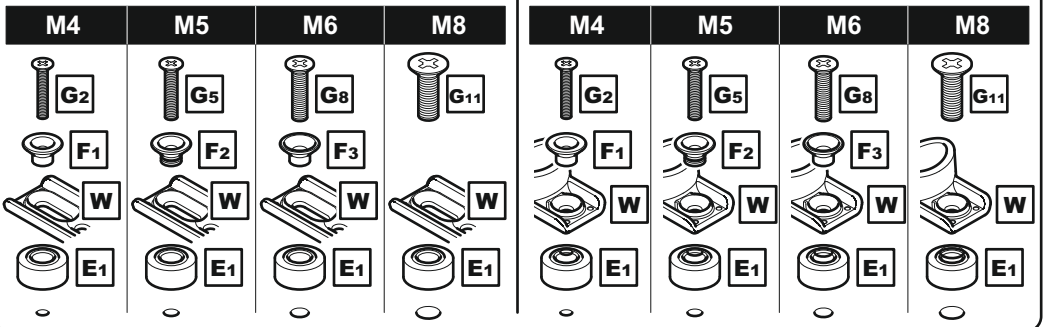

OPTION 3
40mm Wall Space

Top Fixings

Bottom Fixings

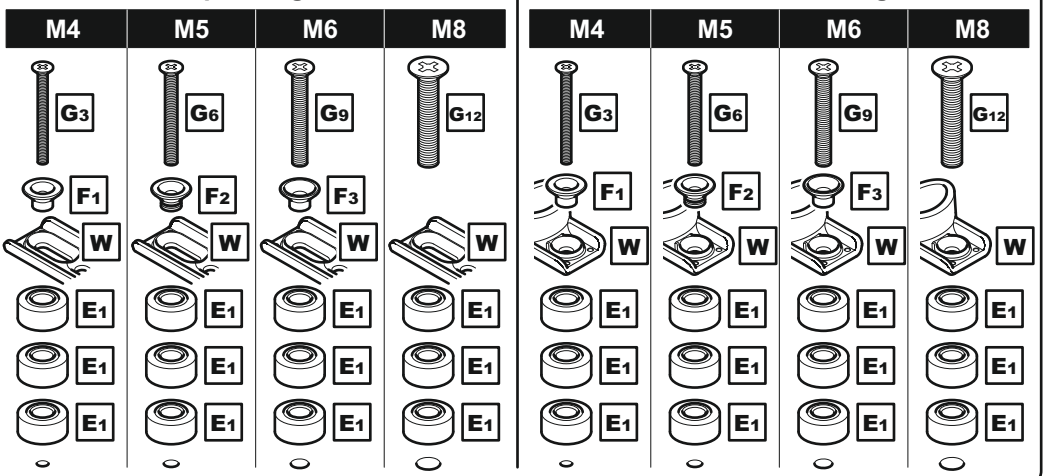

13 Marking Wall For Drill Points

Tilt Position only



Use the marks on the top row that you made in step 11 and make the same marks on the bottom row. You will use the marks on the bottom row to make 2 pencil marks on the wall.

Before marking the wall, determine the wall type that you have (i.e. Solid Wall/Dot & Dab/ Plasterboard/Wood Stud/Metal Stud). Ensure the drilling area is free from mains services (Gas/Electric/Water).

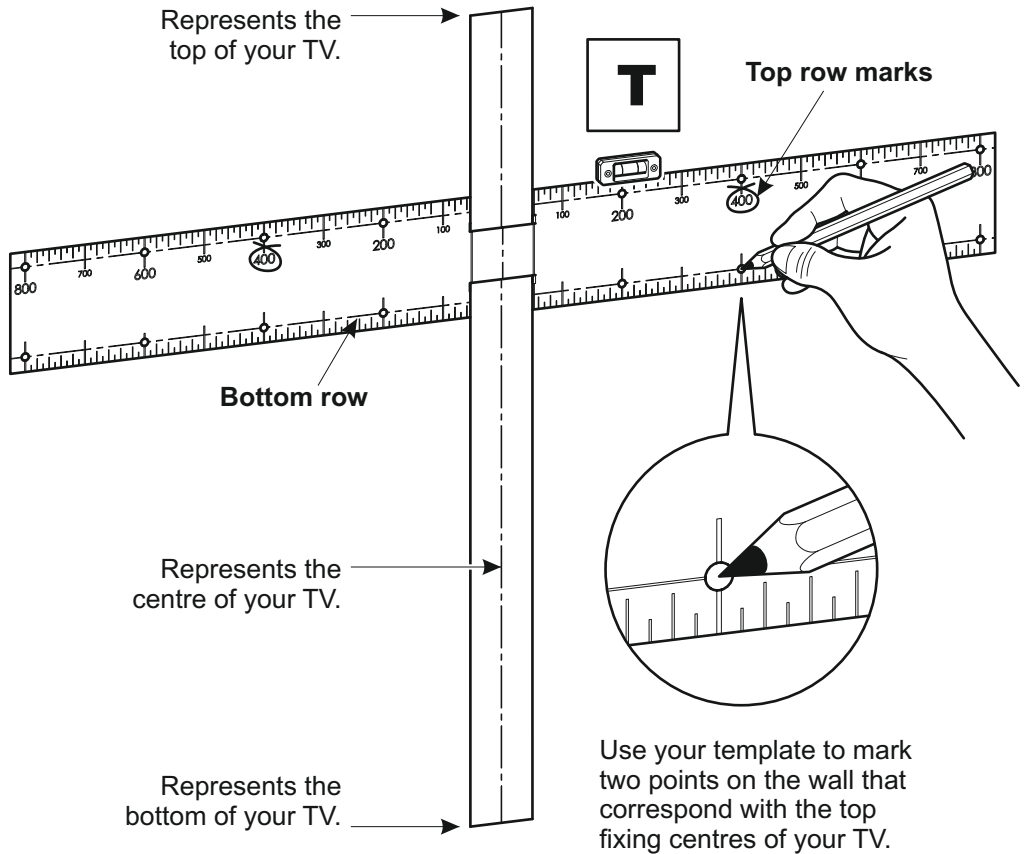

Next, use the Wall Brackets **A** and **B** as a template and position them over the appropriate **PENCIL MARKS** you have made, so that the mark is in the middle of the **CENTRAL HOLE** of the Wall Bracket. Ensure the bracket is level and mark the three **DRILL POINTS** with a pencil. Repeat for other bracket.
Drill six 3mm pilot holes and select appropriate fixings (see section 14)

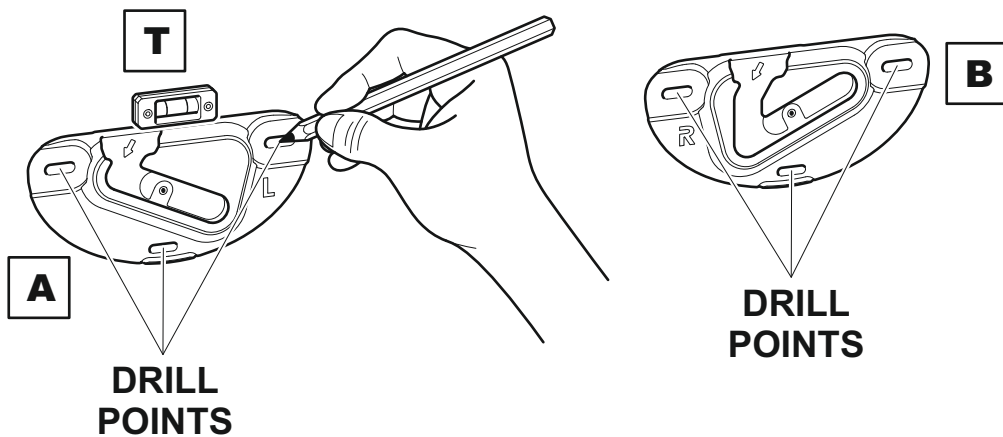
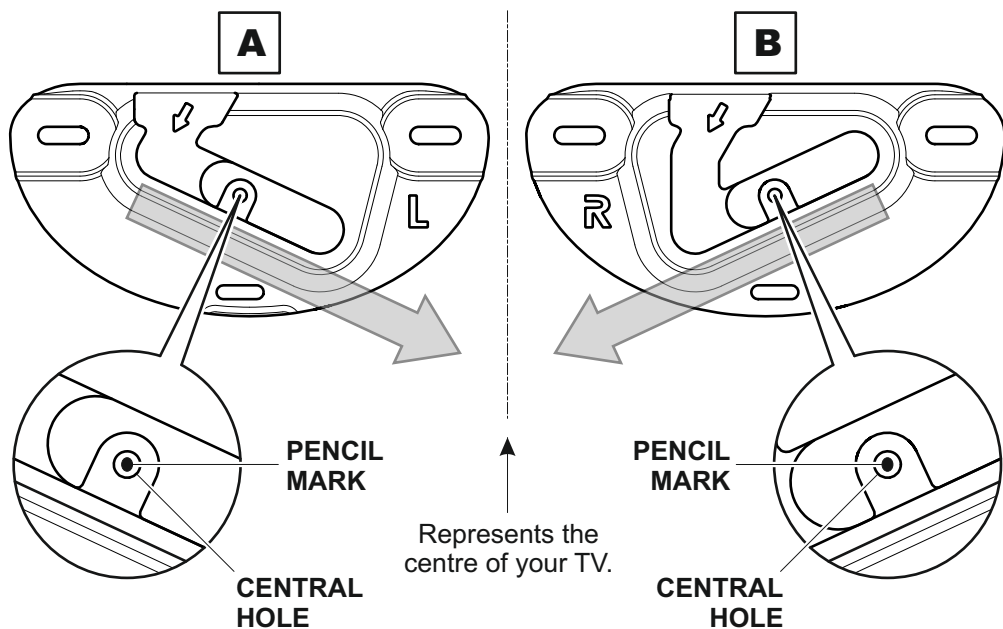

14 Fitting the Wall Bracket

Tilt Position only

Use the correct fixings for your wall type. Mixing fixing screws may be required for installations that span different wall types. **DO NOT OVER TIGHTEN SCREWS.**

Solid Wall

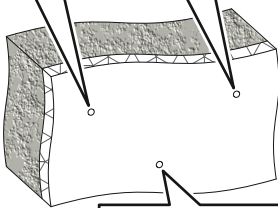
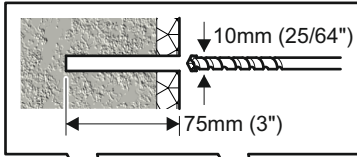

Remove dust from holes

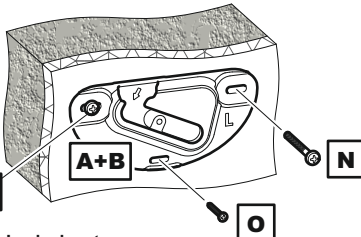
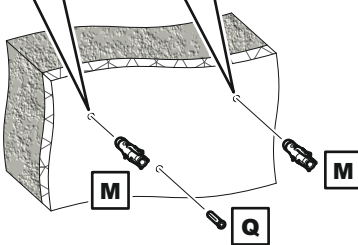
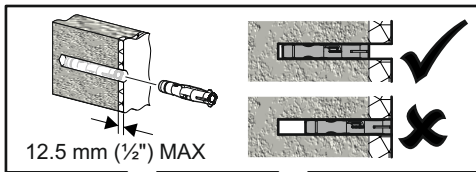
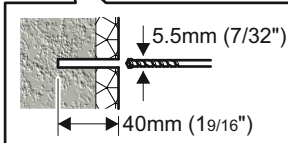

Lubricate screw thread with soap

Dot & Dab

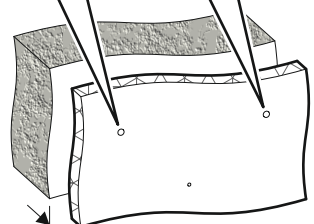
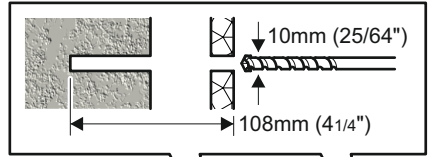

* 40mm (1 9/16") MAX gap

* If gap is above 40mm (1 9/16) use plasterboard fixing method



Remove dust from holes

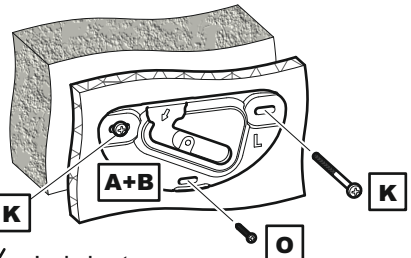
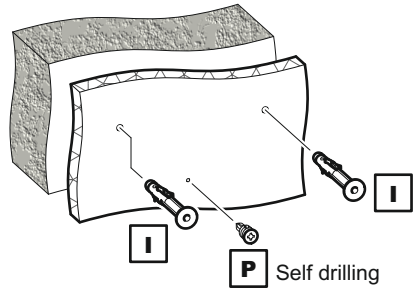

Lubricate screw thread with soap

Plasterboard

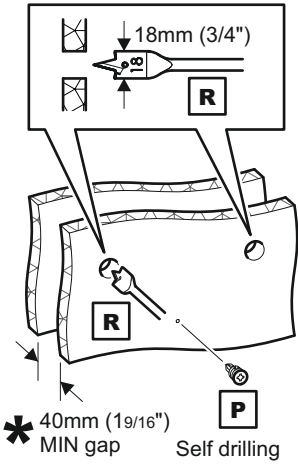

Remove dust from holes

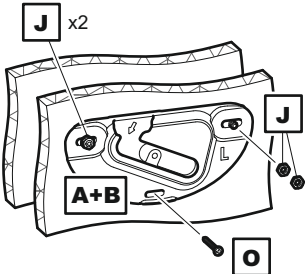
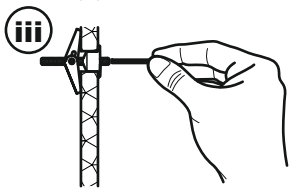
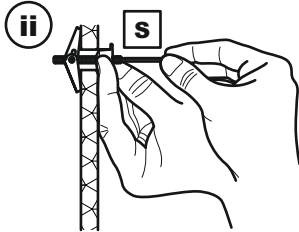
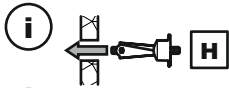

Wood Stud

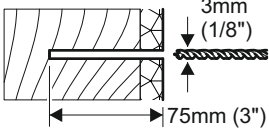
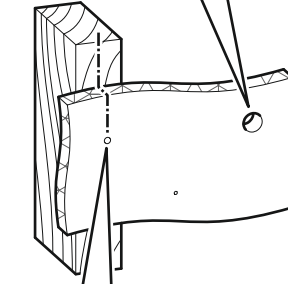
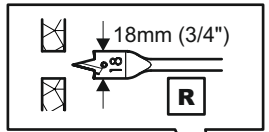

Ensure hole is in the middle of the wood stud

Use Plasterboard Fixing **H**

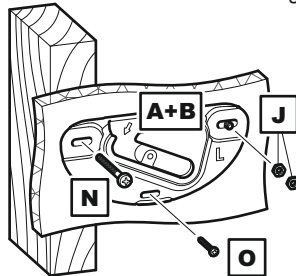
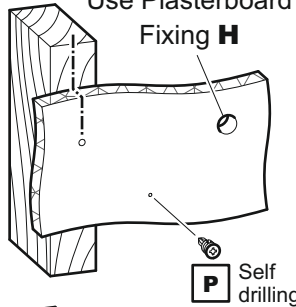

Lubricate screw thread with soap

Only one fixing will be in the wood stud. The other fixings will be in plasterboard (see above)

Metal Stud

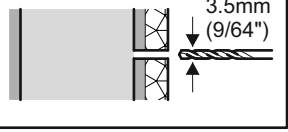
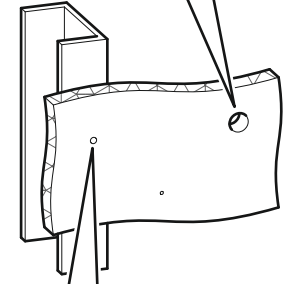
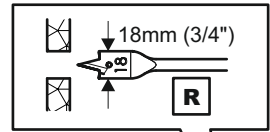

Use Plasterboard Fixing **H**

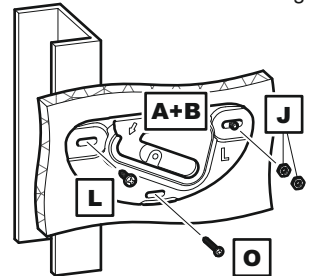
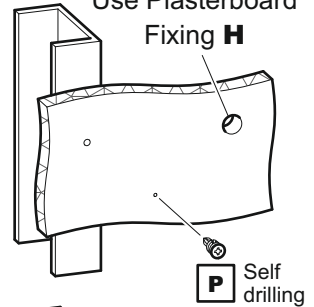

Only one fixing will be in the metal stud. The other fixings will be in plasterboard (see above)

15 Fitting the Wall Bracket Covers

Tilt Position only

On wall bracket covers **A1** & **B1** are 3 retaining tabs. These locate onto 3 retaining lips on wall brackets **A** & **B** and lock the wall bracket covers in position.

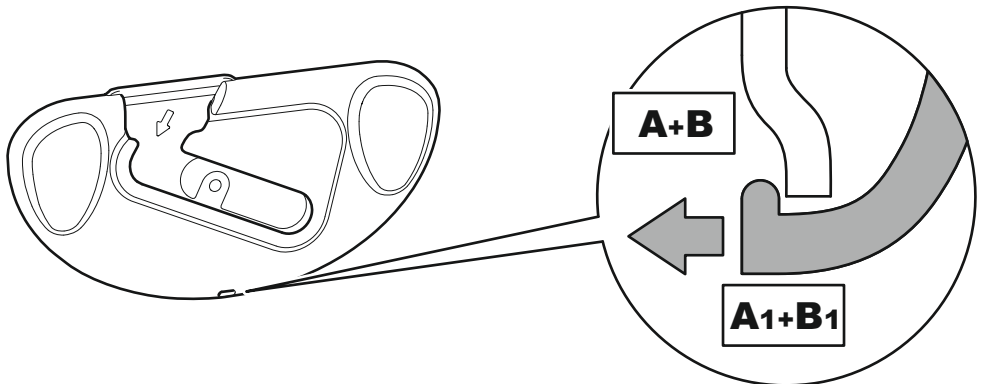
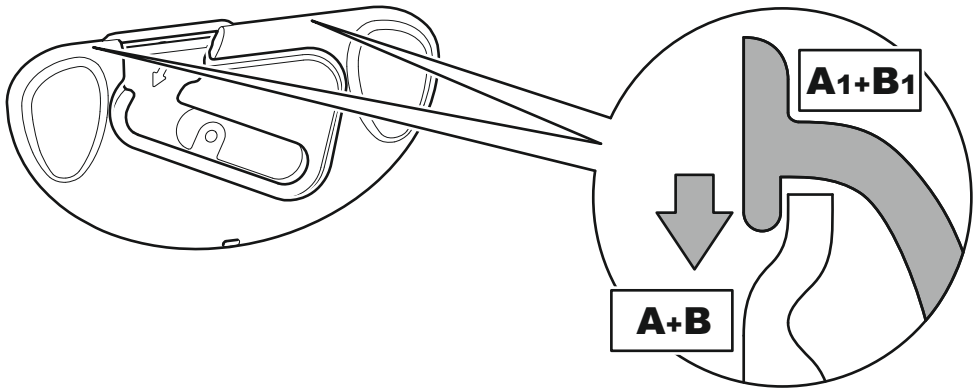
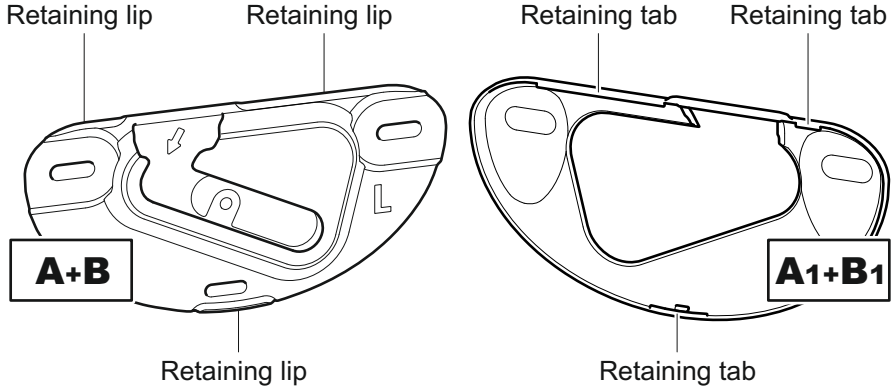

16 Hanging the TV

Tilt Position only

Hanging the TV is a two person job.

Present hangers **C** (on the back of the TV) to the opening on brackets **A** & **B**. Slide down and across into place. Ensure both hangers are fully engaged. If cables from the TV prevent the TV resting against the wall then an alternative hanger configuration will be required (see section 12).

TV must be parallel to wall. Use spacers / stand-offs as shown in section 12.

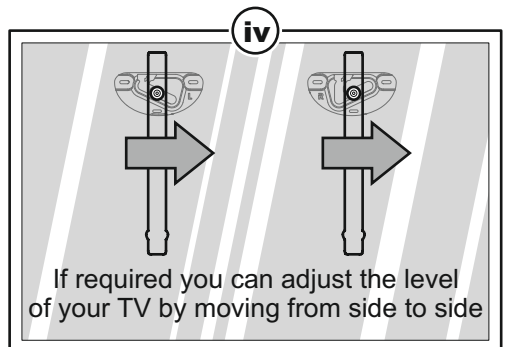
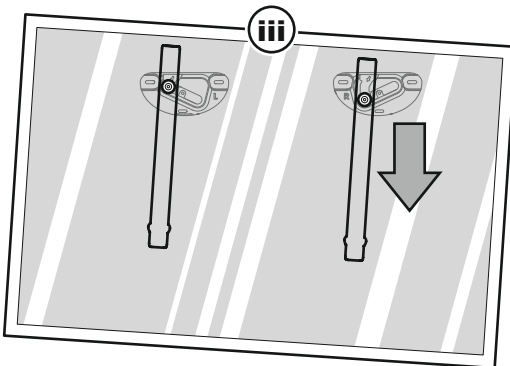
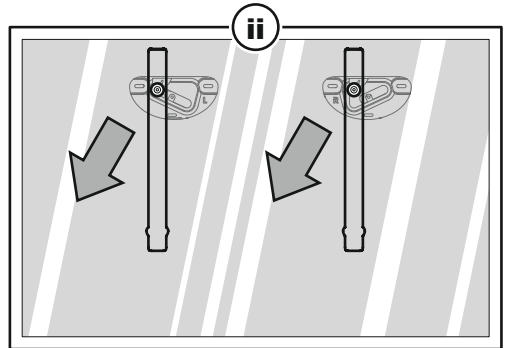
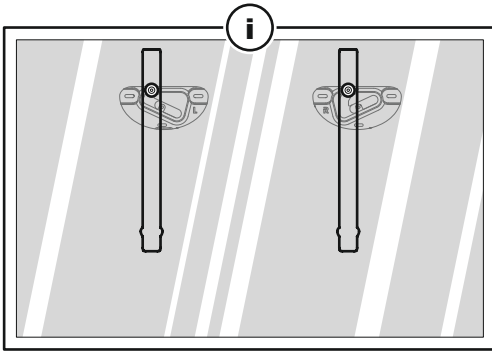
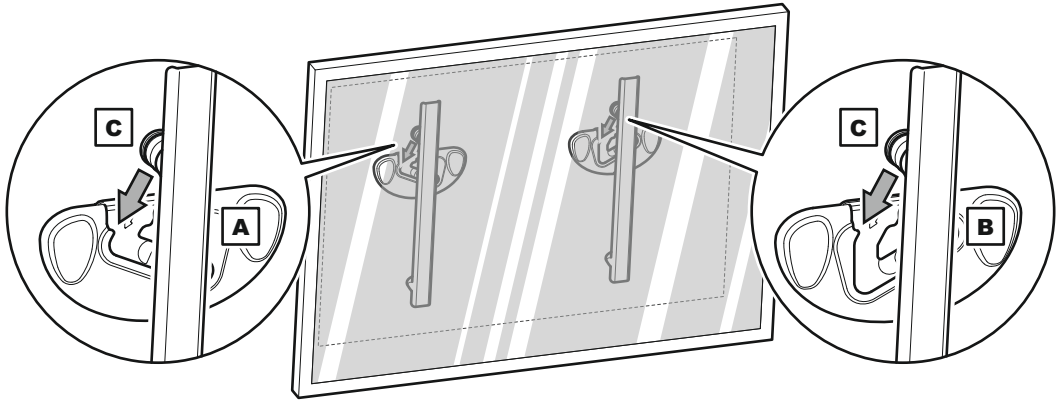

Removing the TV

This is a two person job. To remove the TV reverse the movements as shown above.

Removing the Wall Bracket Covers

Should you want to remove the wall bracket covers please follow the steps below.

