

JML8450

464235 rev02

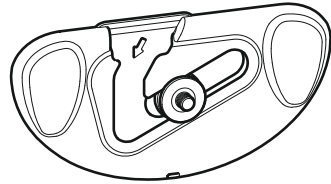
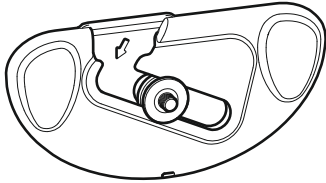

Read through **ALL** instructions before commencing installation.
If you have any questions about this product or issues with installation
contact the customer services helpline before returning this product to
the store. See jl.avfgroup.com/p/jml8450 for more information.

CUSTOMER SERVICES HELP LINE NUMBER:

0333 320 0463



AVF Group Ltd. Hortonwood 30, Telford, Shropshire, TF1 7YE, England

Assembly Overview

Fit Screen Hangers to TV

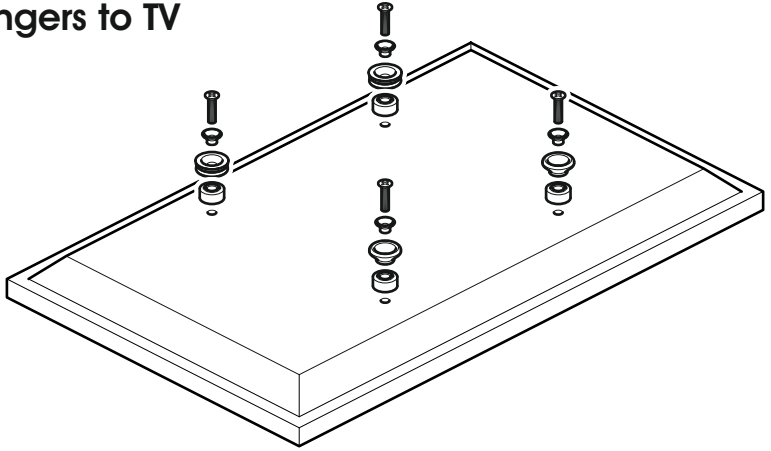

Fitting the Wall Bracket

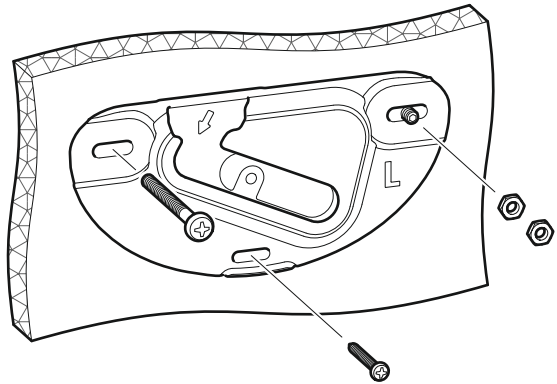

Hanging the TV

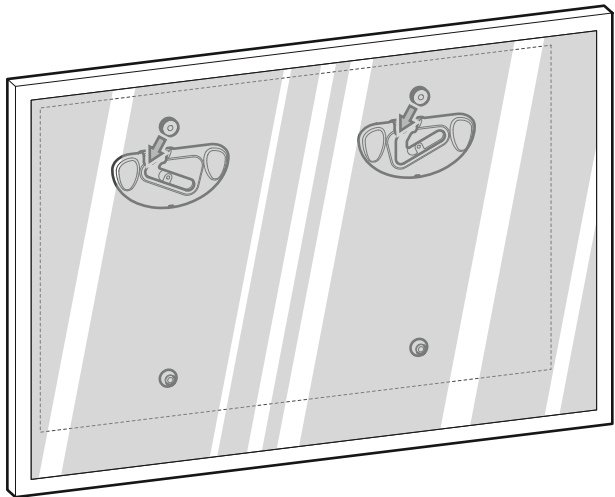

Index

1 Measure the TV fixing holes Width and Height

2 Fit Screen Hangers to TV

3 Assemble Positioning Template

4 Determine Bracket Hole Centres

5 Marking Wall For Drill Points

6 Fitting the Wall Bracket

7 Fitting the Wall Bracket Covers

8 Hanging the TV

Retain all packaging in case the bracket needs to be returned.

Contents may vary from photography/ Illustrations.

You will not need all these parts, so expect there to be some left over depending upon the specification of your TV.

This product is intended for indoor use only. Use of this product outdoors could lead to failure and personal injury.

It is the responsibility of the installer to ensure that the mounting wall is of a suitable standard and void of any services (eg gas, electricity, water etc).

AVF accept no responsibility for any damage or loss caused by installing this product in a sub standard wall.

Tools Recommended

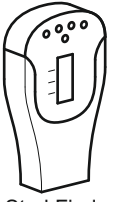

Stud Finder

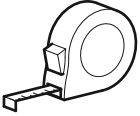

Ø5.5mm (7/32") Masonry



Ø10mm (25/64") Masonry

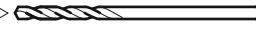

Ø3.5mm (9/64") Metal



Ø3mm (1/8") Wood

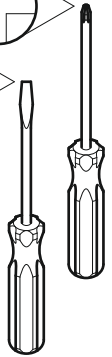
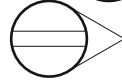
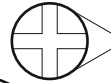
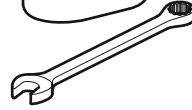
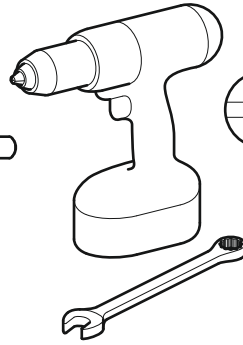

Boxed Parts

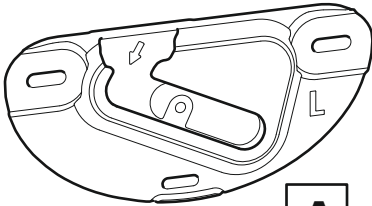

A

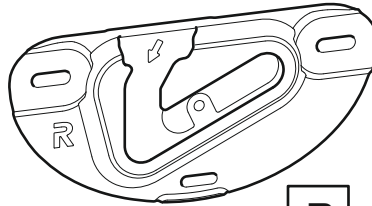

B

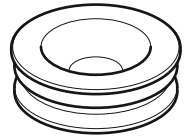

C

x2

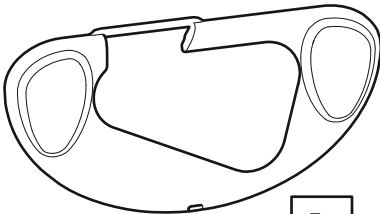

A1

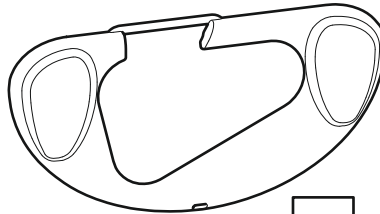

B1

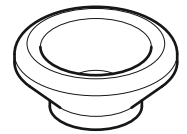

D

x2

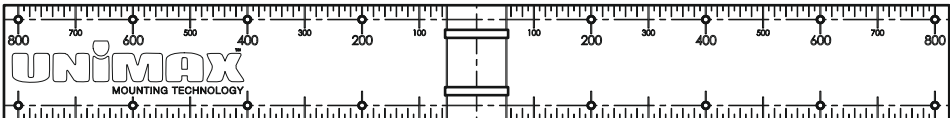

U1

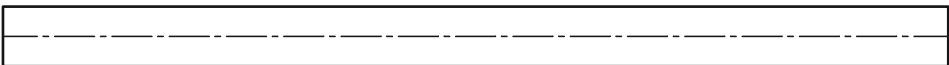

U2

TV Screws, Reducers and Spacers

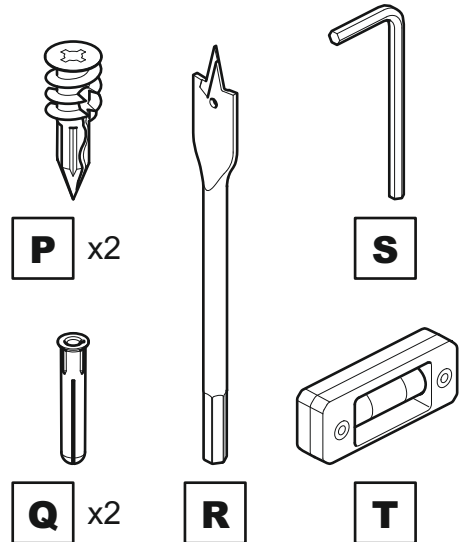
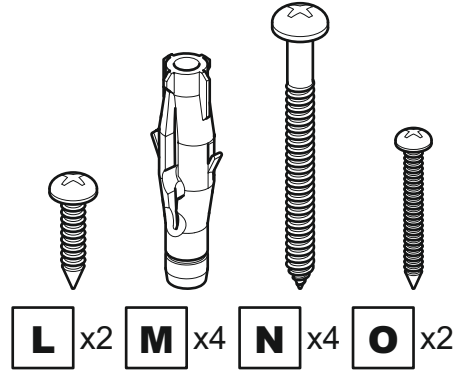
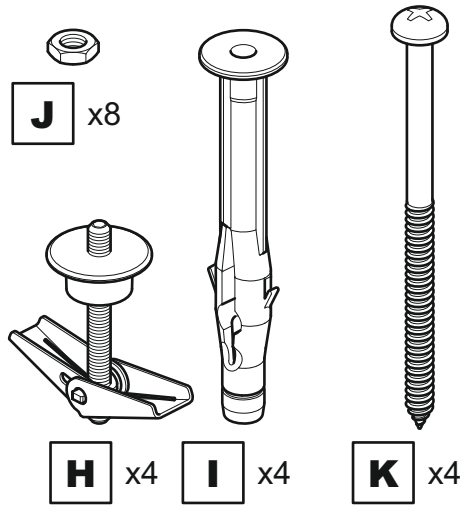
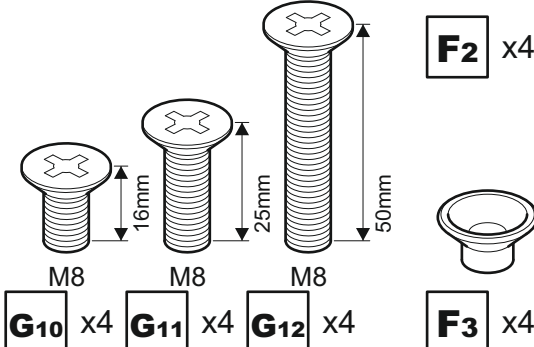
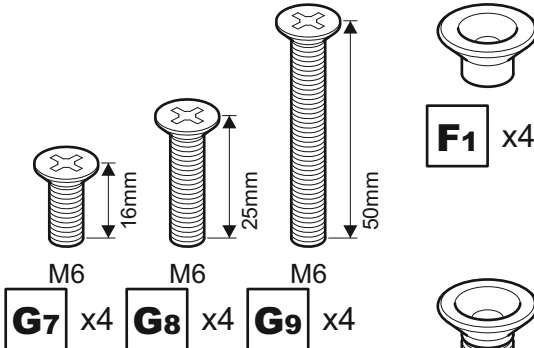
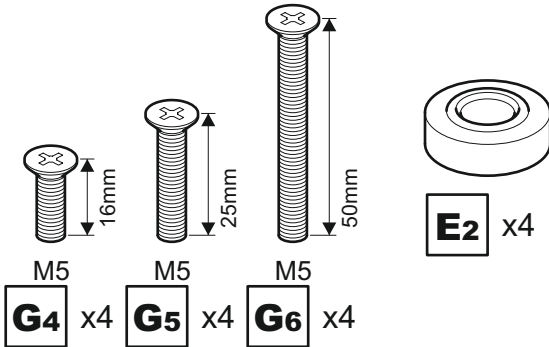
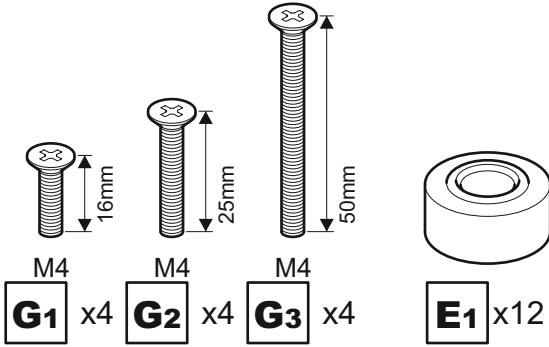

Remove the Wall Bracket Covers and keep for step 7

Wall bracket covers **A1** & **B1** are removed in the same way.

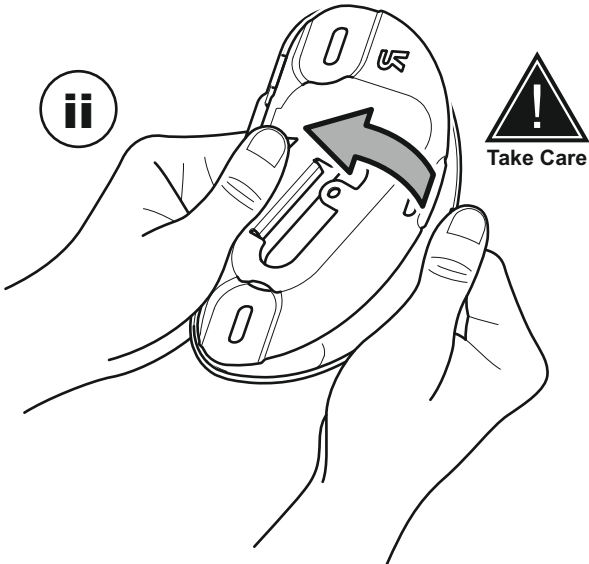
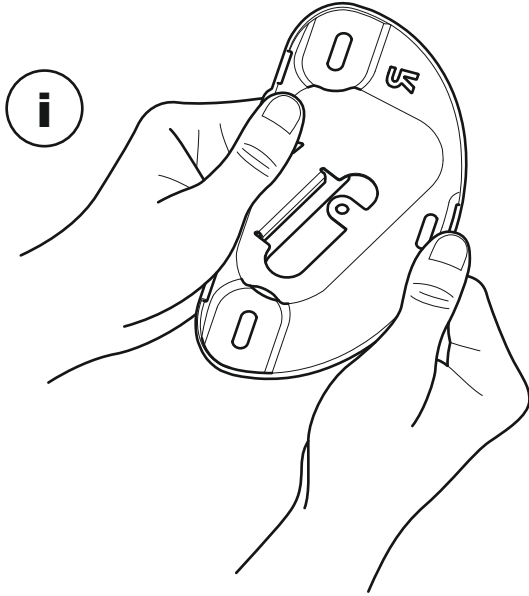

1 Measure the TV fixing holes Width and Height

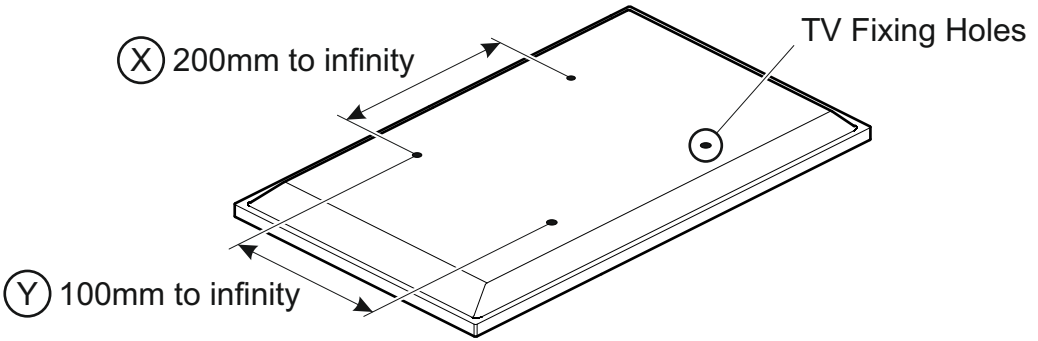

If width (X) is less than 200mm or height (Y) is less than 100mm
STOP installation now and contact the customer help line

You are provided with 4 diameters of TV fixing screws, **M4**, **M5**, **M6** and **M8**. Determine the screw diameter that fits and remember for step 2.

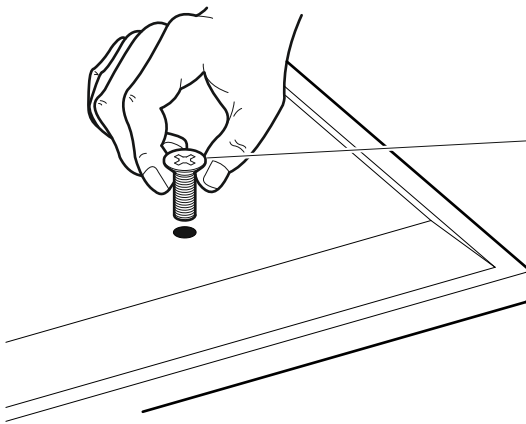

M4 =	G1-G3
M5 =	G4-G6
M6 =	G7-G9
M8 =	G10-G12



After completing step 2 you will have TV fixing screws left over,
please keep for future reference

2 Fit Screen Hangers to TV

Once you have established which screw diameter you need for your TV you will need to choose which wall spacing you require. Check the back of your TV and use the **OPTION** that fits your TV. Please see page opposite for more details.

OPTION 1
12mm Wall Space

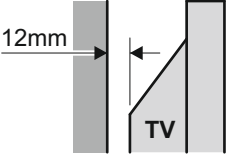

Suitable for TVs with a flat back and no obstructions

OPTION 2
20mm Wall Space

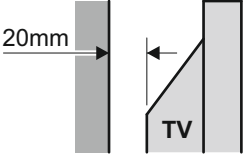

Suitable for TVs with small to medium obstructions eg power supply, mouldings etc

OPTION 3
40mm Wall Space

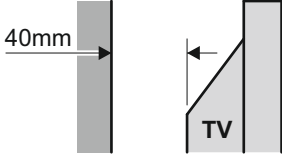

Suitable for TVs with large obstructions eg power supply, mouldings etc

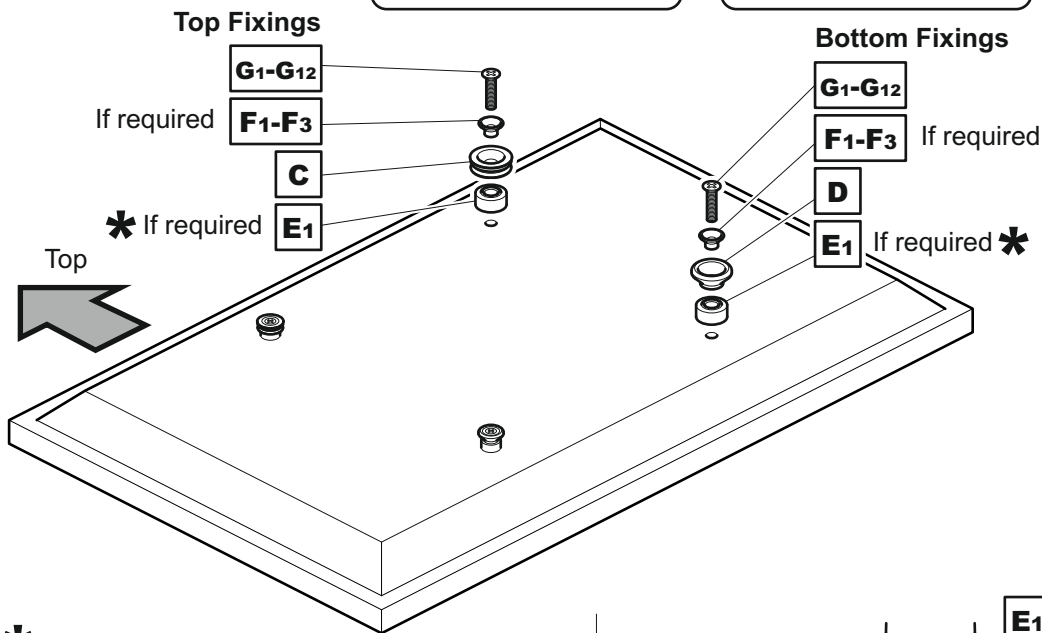

* In certain circumstances it may be necessary to use red spacer **E2** as either a replacement or addition to spacer **E1**.

When is it necessary to use red spacers **E2**?

It is recommended that when fitting Hangers **C** and Stand-offs **D** to your TV you have at least 5-10mm of screw engagement. In certain circumstances you may need to use red spacers **E2** as either a replacement, or together with spacers **E1** to achieve this. Whenever you use red spacers **E2** you must use all 4 provided.

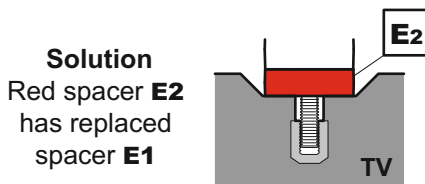
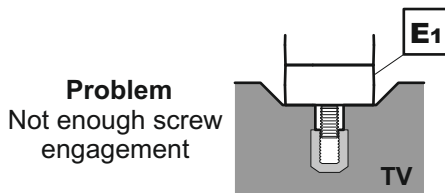

OPTION 1

12mm Wall Space

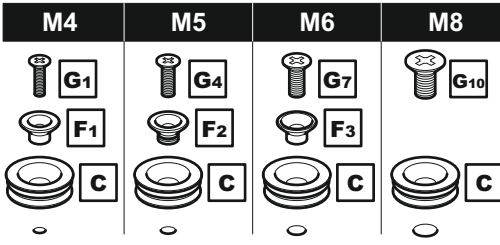
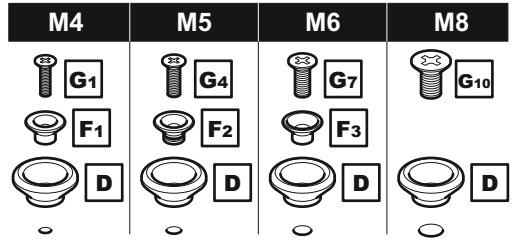
Top Fixings**Bottom Fixings****OPTION 2**

20mm Wall Space

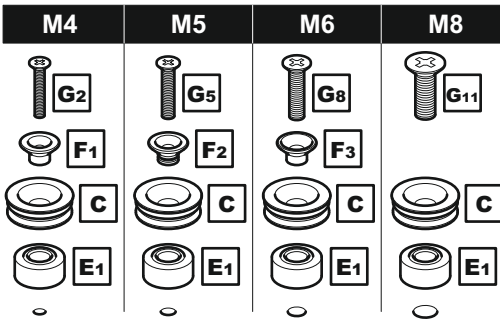
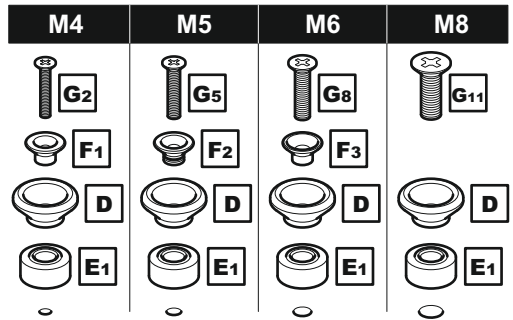
Top Fixings**Bottom Fixings****OPTION 3**

40mm Wall Space

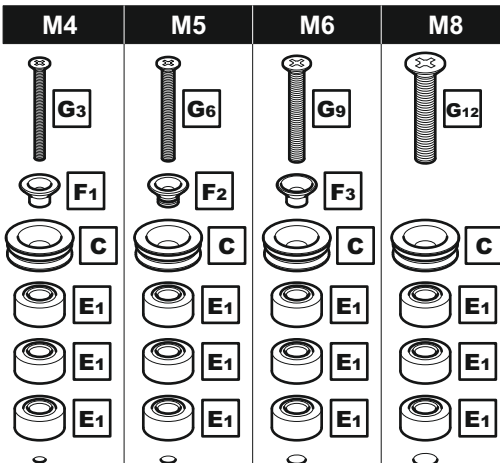
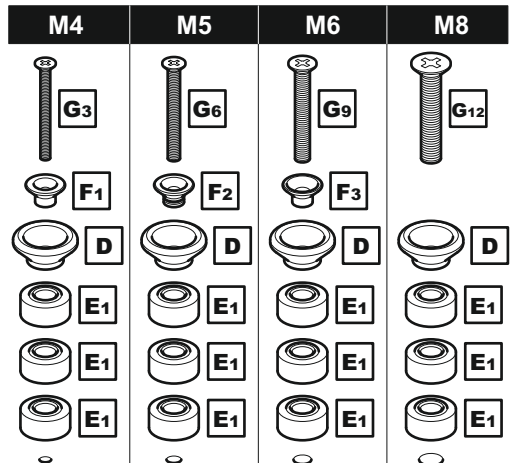
Top Fixings**Bottom Fixings**

3 Assemble Positioning Template

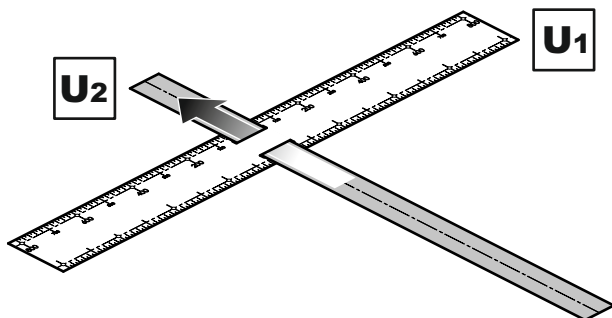

4 Determine Bracket Hole Centres

Lay the template on the back of the TV and follow the instructions below.

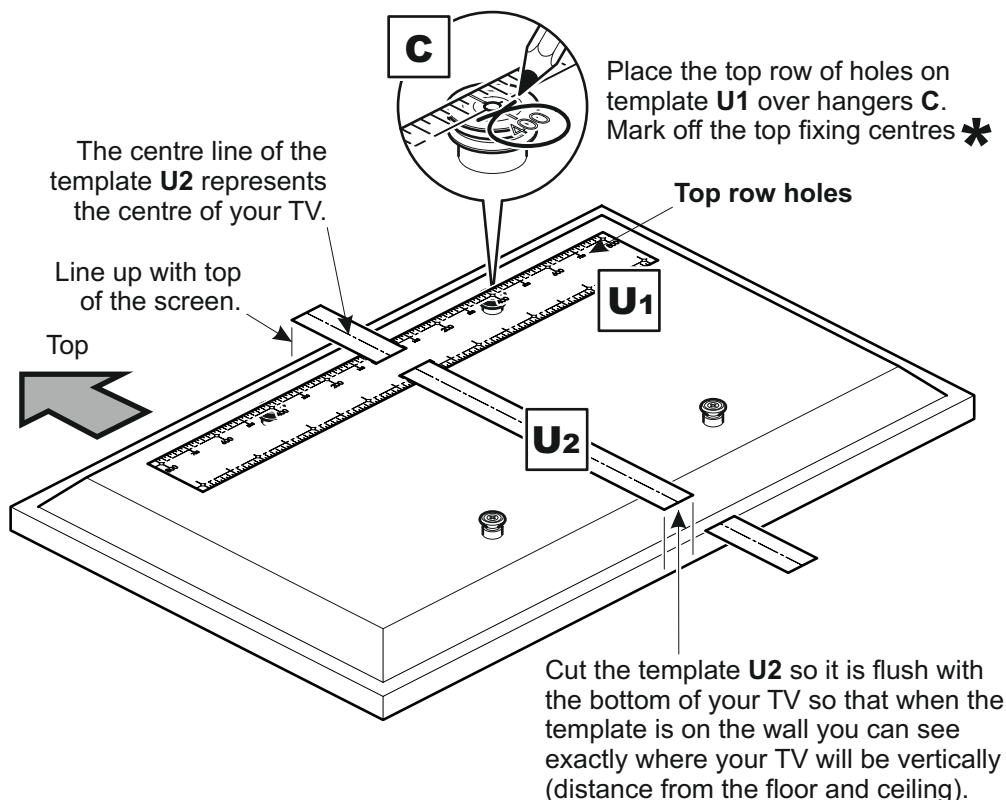

* If hangers **C** do not line up with any holes on the template then ensure template is firmly in position and punch 2 holes to match your top fixing centres with a pencil or sharp object.

5 Marking Wall For Drill Points

Before marking the wall, determine the wall type that you have (i.e. Solid Wall/ Dot & Dab/ Plasterboard/ Wood Stud/Metal Stud). Ensure the drilling area is free from mains services (Gas/Electric/Water).

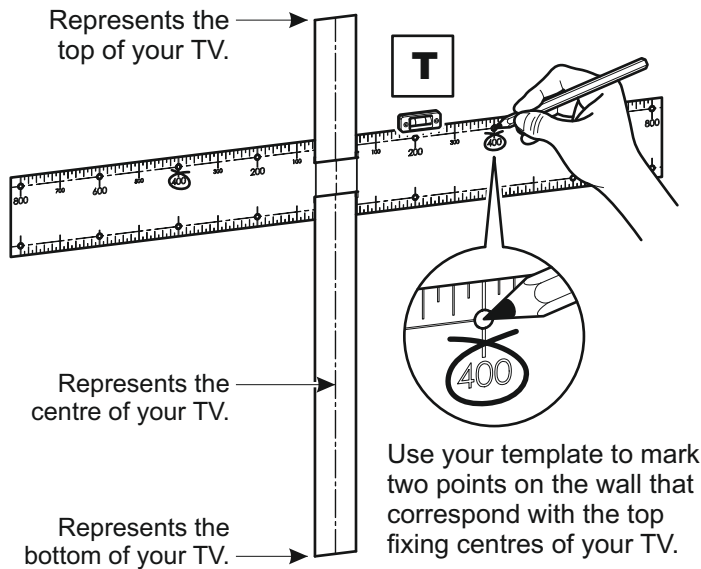

Next, use the Wall Brackets **A** and **B** as a template and position them over the appropriate **PENCIL MARKS** you have made, so that the mark is in the middle of the **CENTRAL HOLE** of the Wall Bracket. Ensure the bracket is level and mark the three **DRILL POINTS** with a pencil. Repeat for other bracket.

Drill six 3mm pilot holes and select appropriate fixings (see section 6)

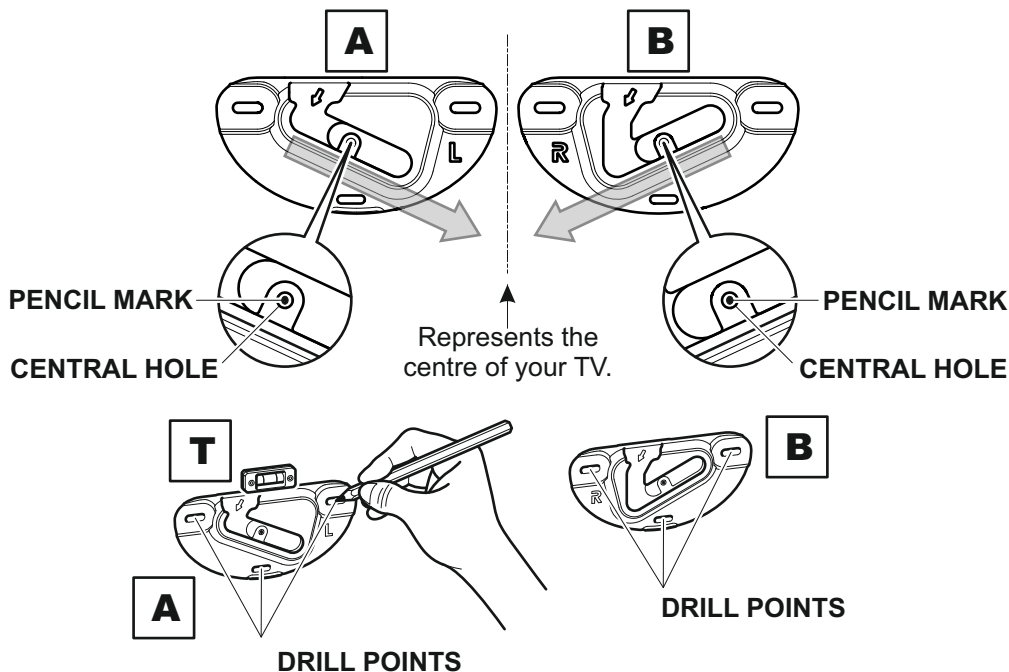

6 Fitting the Wall Bracket

Use the correct fixings for your wall type. Mixing fixing screws may be required for installations that span different wall types. **DO NOT OVER TIGHTEN SCREWS.**

Solid Wall

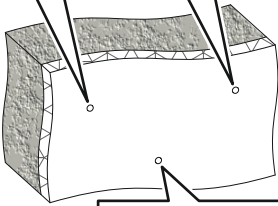
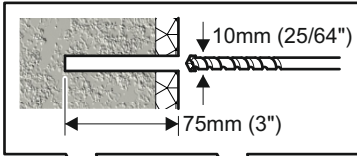

Remove dust from holes

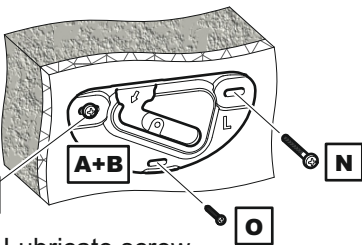
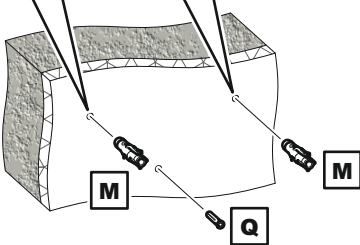
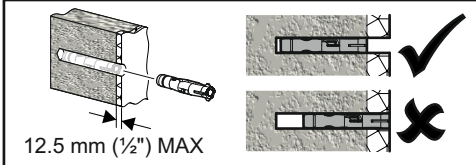
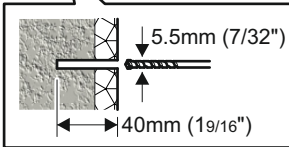

Lubricate screw thread with soap

Dot & Dab

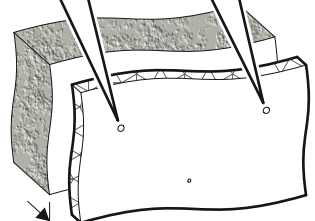
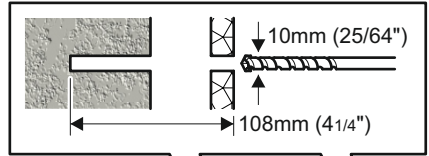

* 40mm (1 9/16") MAX gap

* If gap is above 40mm (1 9/16") use plasterboard fixing method



Remove dust from holes

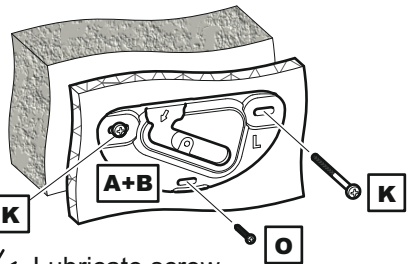
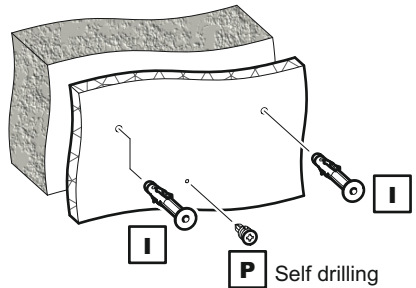

Lubricate screw thread with soap

Plasterboard

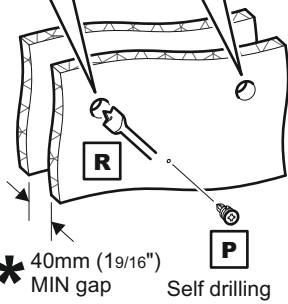
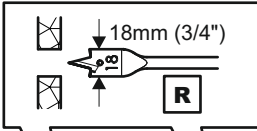

Remove dust from holes

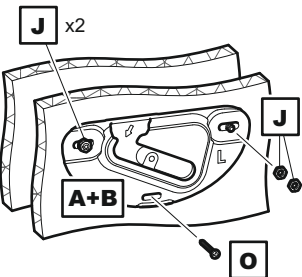
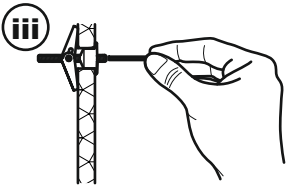
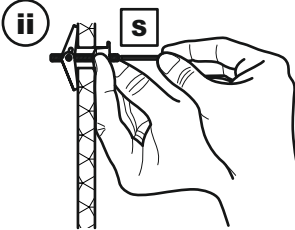
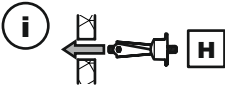

Wood Stud

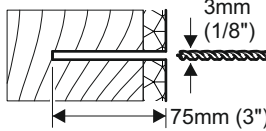
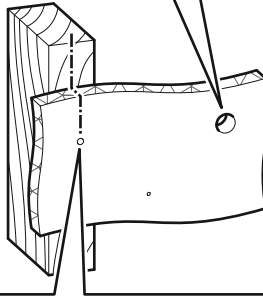
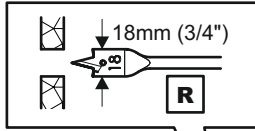

Ensure hole is in the middle of the wood stud

Use Plasterboard Fixing **H**

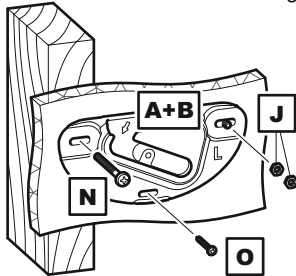
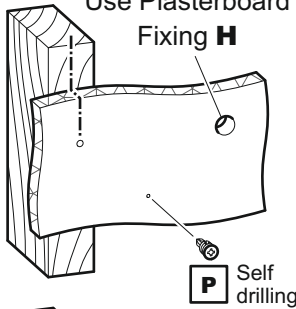

Lubricate screw thread with soap

Only one fixing will be in the wood stud. The other fixings will be in plasterboard (see above)

Metal Stud

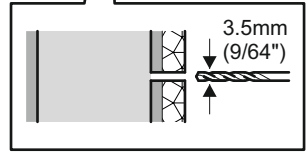
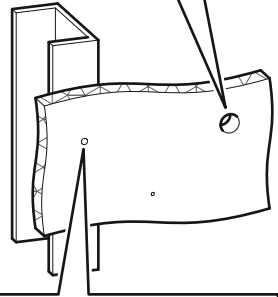
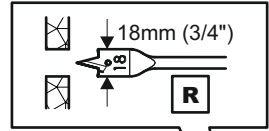

Use Plasterboard Fixing **H**

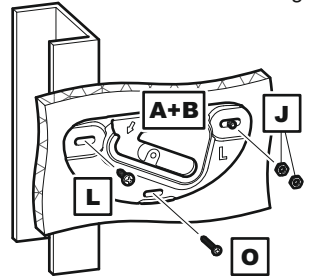
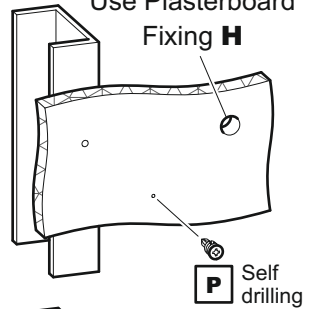

Only one fixing will be in the metal stud. The other fixings will be in plasterboard (see above)

7 Fitting the Wall Bracket Covers

On wall bracket covers **A1** & **B1** are 3 retaining tabs. These locate onto 3 retaining lips on wall brackets **A** & **B** and lock the wall bracket covers in position.

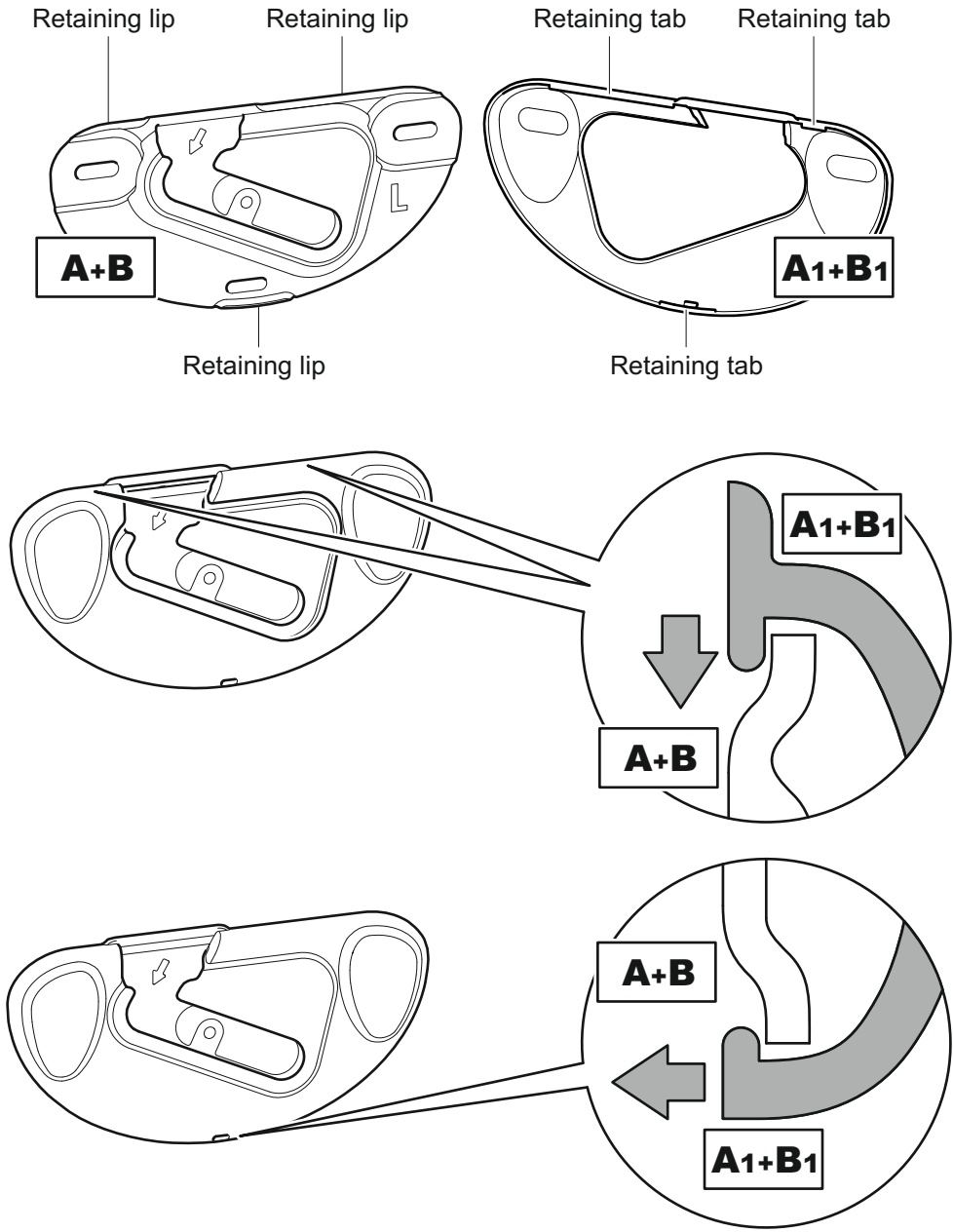

8 Hanging the TV

Flat to Wall only

Hanging the TV is a two person job.

Present hangers **C** (on the back of the TV) to the opening on brackets **A** & **B**. Slide down and across into place. Ensure both hangers are fully engaged. If cables from the TV prevent the TV resting against the wall then an alternative hanger configuration will be required (see section 2).

TV must be parallel to wall. Use spacers / stand-offs as shown in section 2.

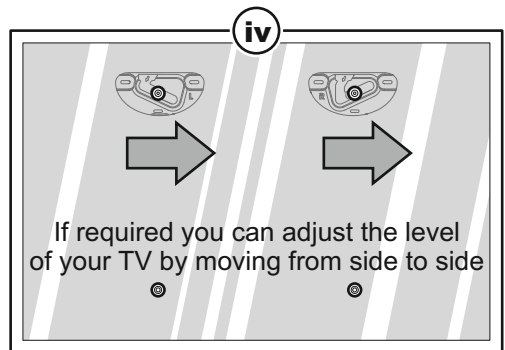
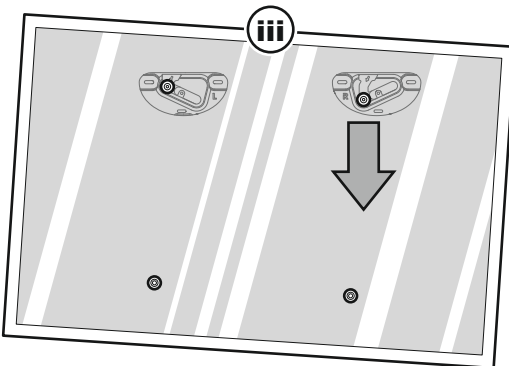
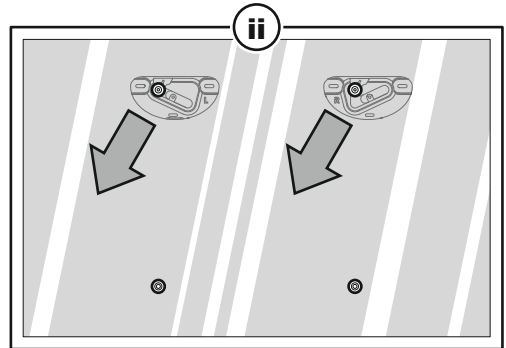
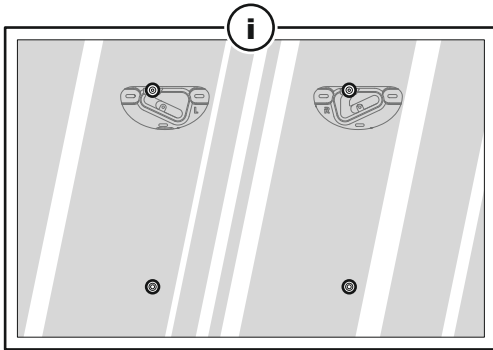
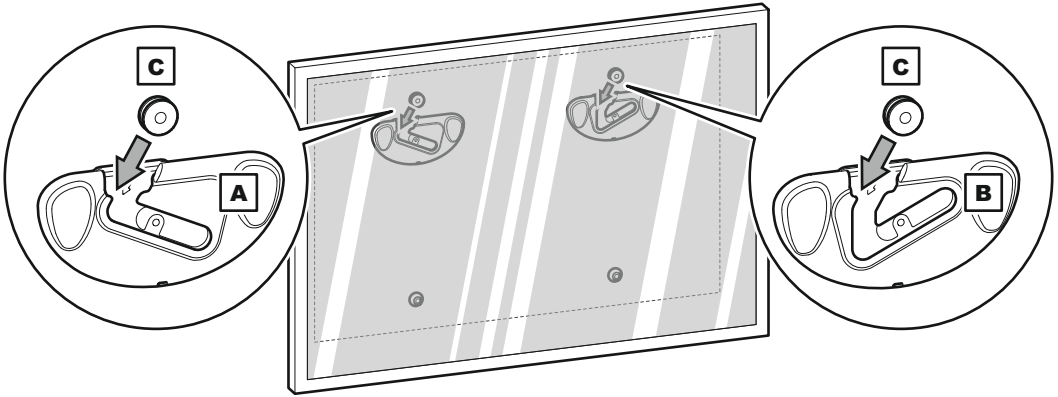

Removing the TV

This is a two person job. To remove the TV reverse the movements as shown above.

Removing the Wall Bracket Covers

Should you want to remove the wall bracket covers please follow the steps below.

