

2

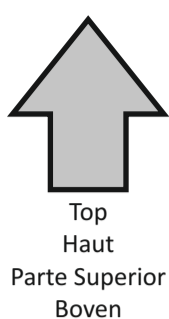

Top
Haut
Parte Superior
Boven

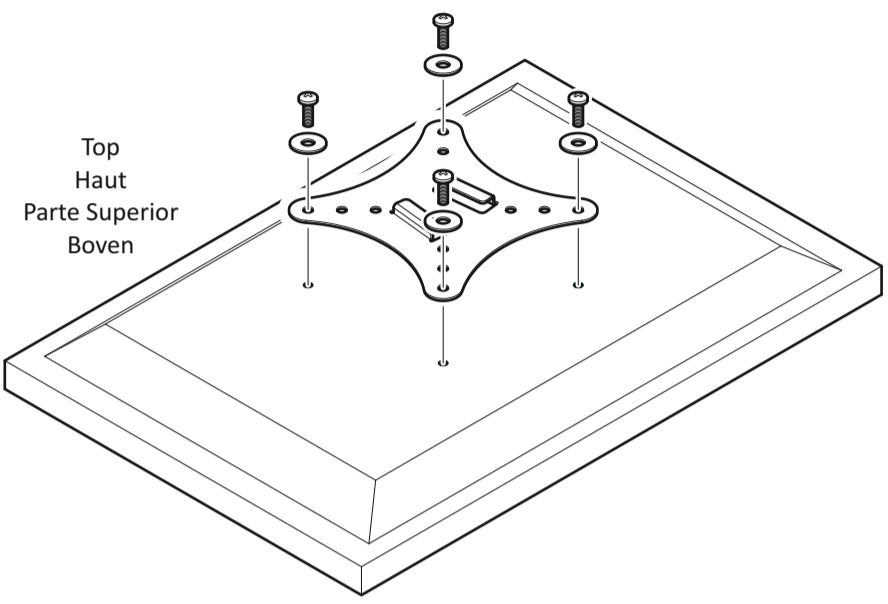
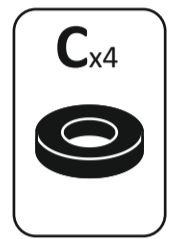
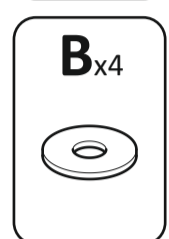
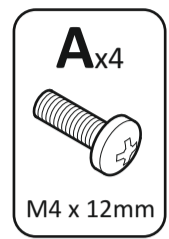
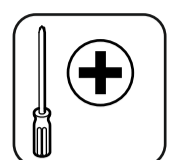
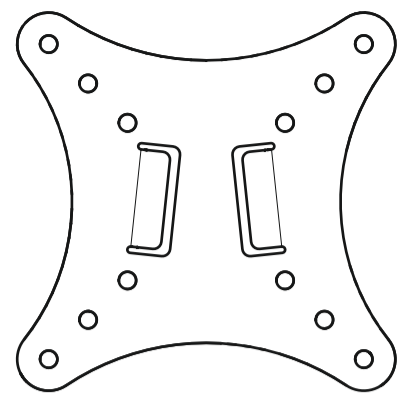

Top
Haut
Parte Superior
Boven

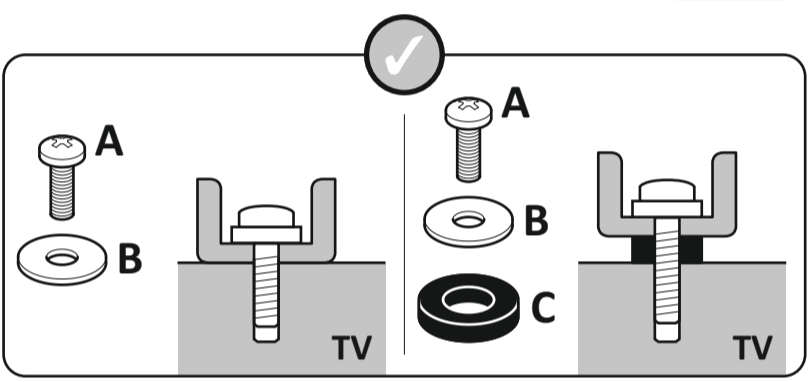
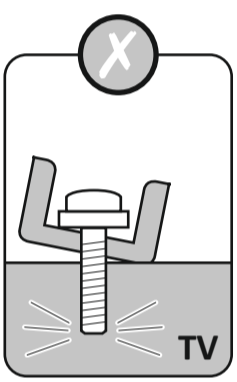

3

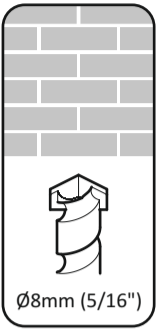
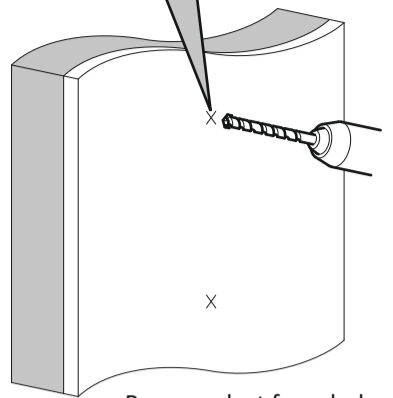
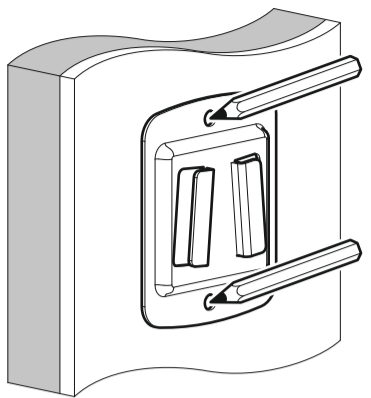
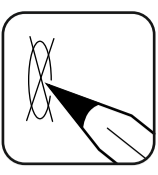
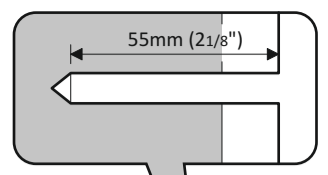
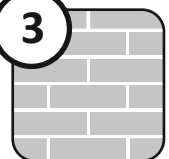

Remove dust from hole
Retirez la poussière du trou
Elimine el polvo del agujero
Verwijder stof uit het gat

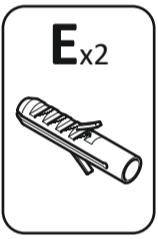
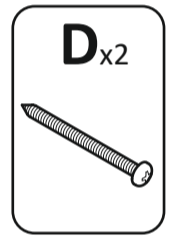
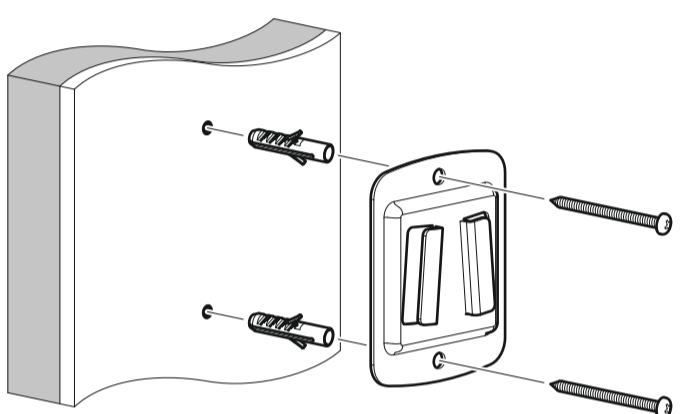
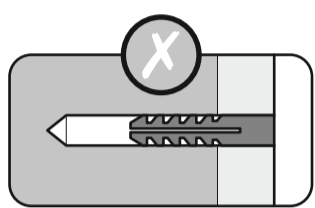
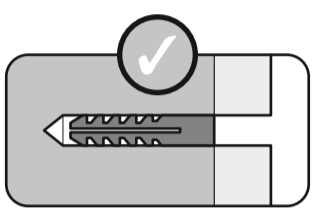

Lubricate screw thread with soap
Lubrifiez le pas de vis avec du savon
Lubrique la rosca del tornillo con jabón
Vet het schroefdraad in met zeep

3

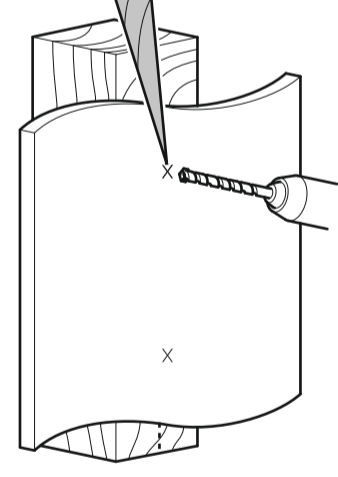
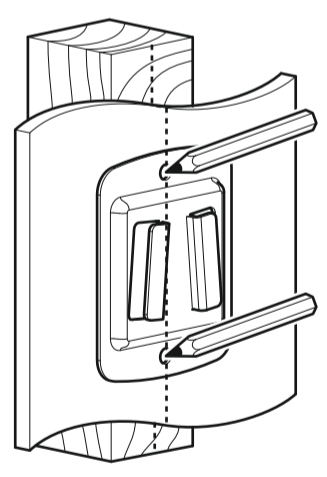
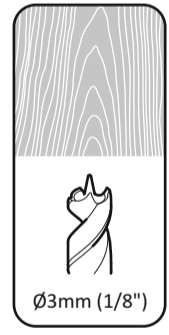
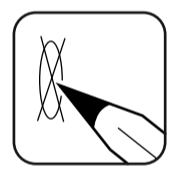
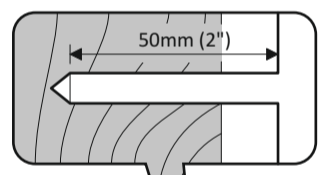
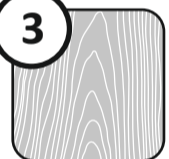

Ensure bracket is in the centre of the wood stud
Assurez-vous que l'applique est au centre de la latte de bois
Asegúrese de que el soporte está en el centro de la viga de madera
Zorg ervoor dat de steun zich in het centrum van de houten steun bevindt

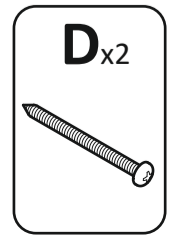
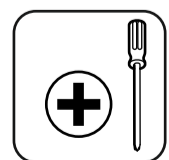
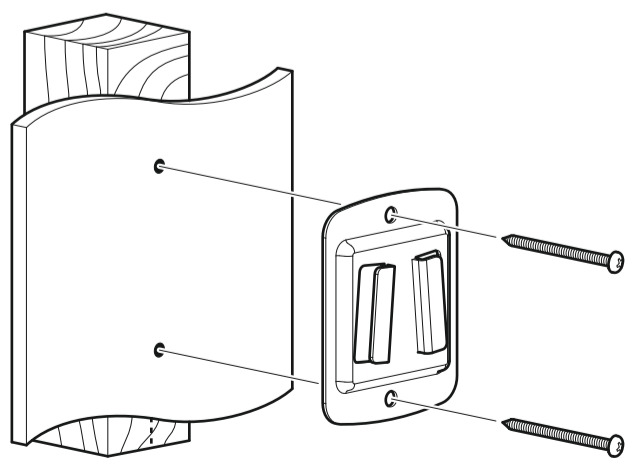

Lubricate screw thread with soap
Lubrifiez le pas de vis avec du savon
Lubrique la rosca del tornillo con jabón
Vet het schroefdraad in met zeep

4

