

34 MIN
(ADDITIONAL SPACERS INCLUDED)

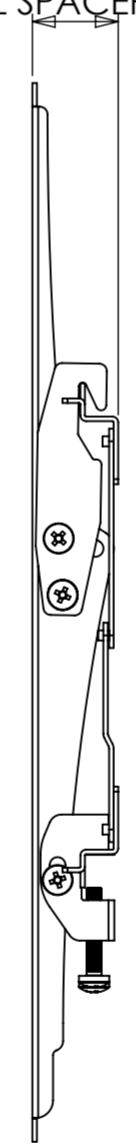

15.50° MAX TILT

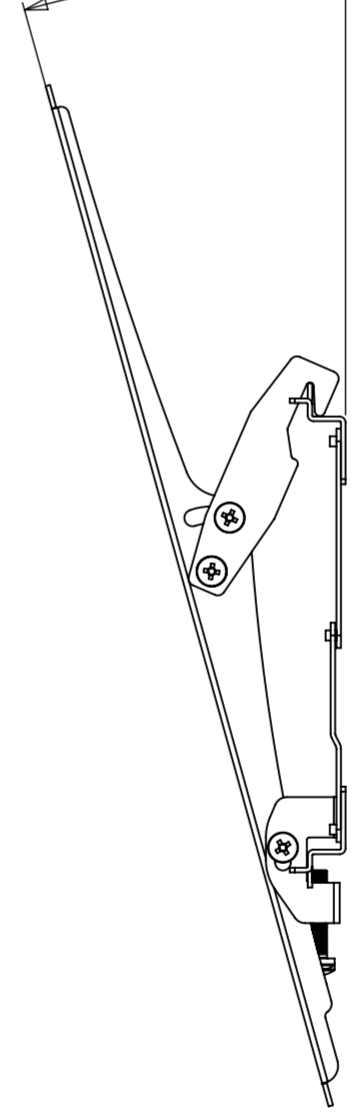

PRODUCT WEIGHT 1909.93 grams
(AS SHOWN WITHOUT PACKAGING AND FIXINGS)

The copyright of this drawing is the property of AVF Group Ltd