

50/75/100 VESA

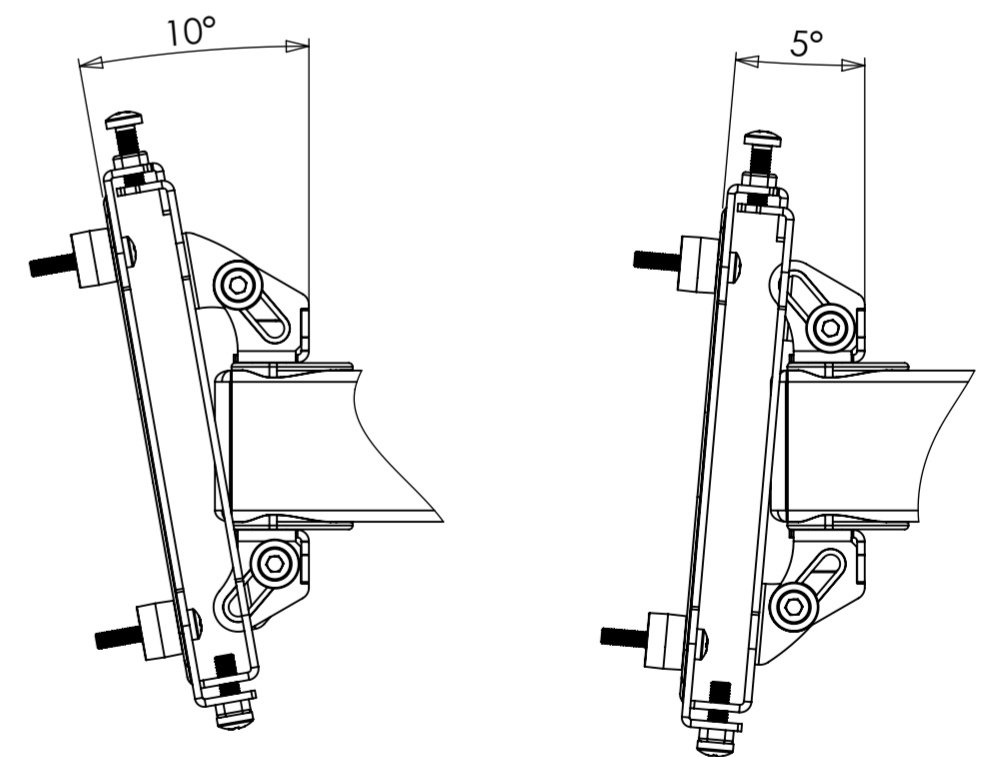
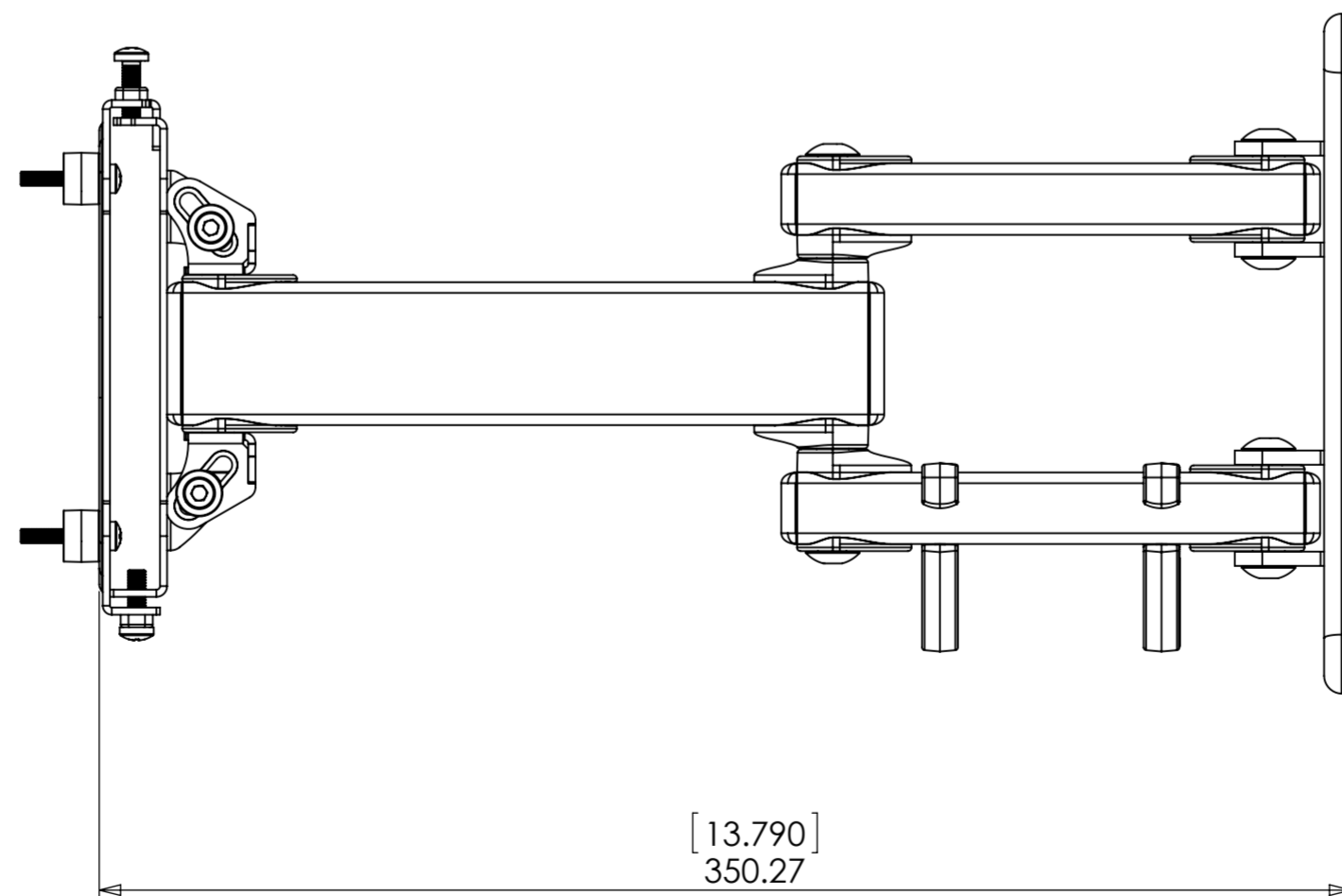

**WEIGHT 2028.80 g**  
(AS SHOWN WITHOUT PACKAGING OR FIXINGS)