

www.avfgroup.com

469103 rev00

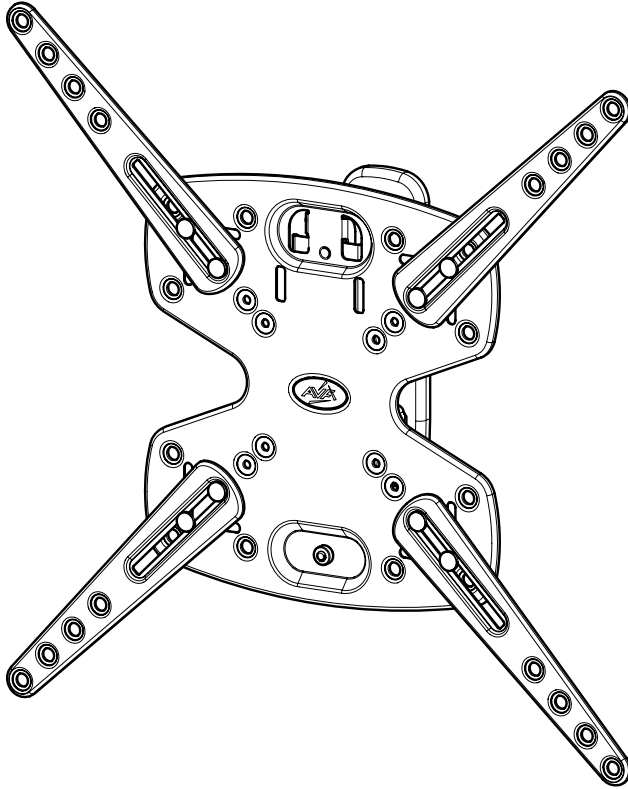

35kg
77lbs



Read through **ALL** instructions before commencing installation.

If you have any questions about this product or issues with installation, contact the customer services helpline before returning this product to the store.

Installation video guide and TV Height
Calculator tool at myTVMount.com

UK-based support team:
0333 320 0463

Phone lines open Mon-Fri during AVF office hours



myTVMount.com

Assembly Overview

Fit the TV Mounting Plate

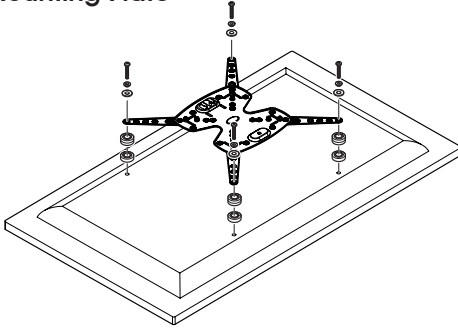

Fit the Wall Bracket

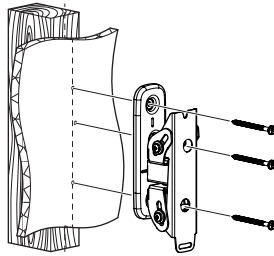

Hang the TV

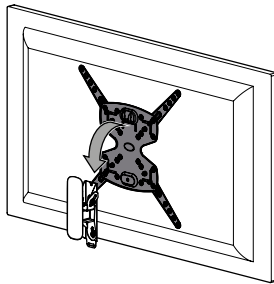

Suitable Wall Types

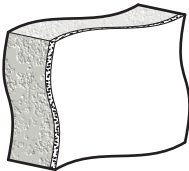

Solid Wall

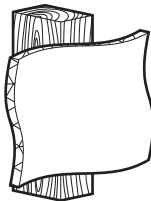

Wood Stud

Tools Recommended

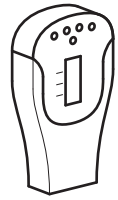

Stud Finder



Ø10mm (25/64")
Masonry

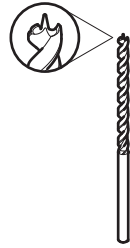

Ø3mm (1/8")
Wood

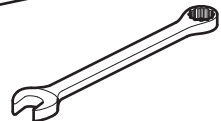
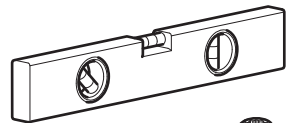
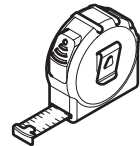
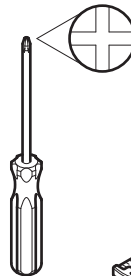
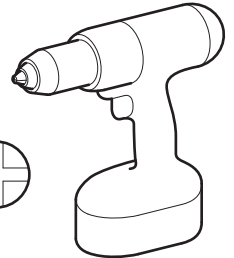

Index

1 Measure the TV fixing holes Width and Height

2 Preparing the TV Mounting Plate

3 Fitting the TV Mounting Plate

4 Fitting the Wall Bracket

5 Hanging the TV

6 Tilt Adjustment

7 TV Levelling

Retain all packaging in case the product needs to be returned.

Contents may vary from photography / illustrations.

You will not need all these parts, so expect there to be some left over depending upon the specification of your TV.

This product is intended for indoor use only. Use of this product outdoors could lead to failure and personal injury.

It is the responsibility of the installer to ensure that the mounting wall is of a suitable standard and void of any services (eg gas, electricity, water etc).

AVF accept no responsibility for any damage or loss caused by installing this product in a substandard wall.

Boxed Parts

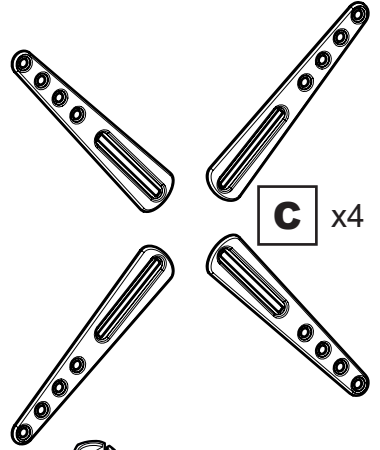
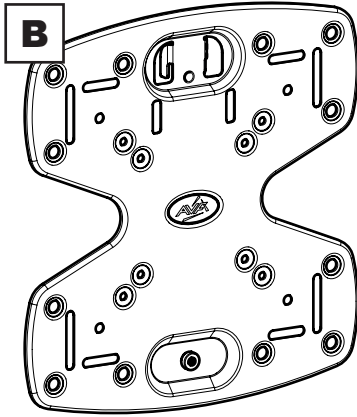
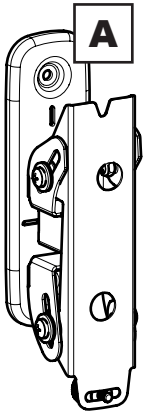

C x4

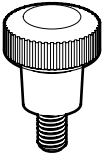
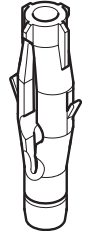
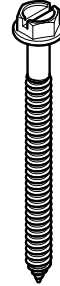

M6



M6

F x1

G x1

H x8

I x8

J x16

N x3

O x3

TV Screws, Reducers and Spacers



L1 x4



L2 x4



M1 x4



M2 x4



M4

K1 x4

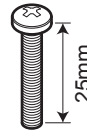

M4

K2 x4

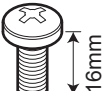

M6

K3 x4

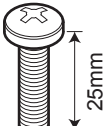

M6

K4 x4

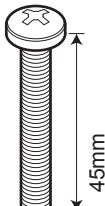

M6

K5 x4

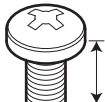

M8

K6 x4

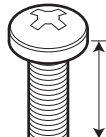

M8

K7 x4

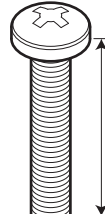

M8

K8 x4

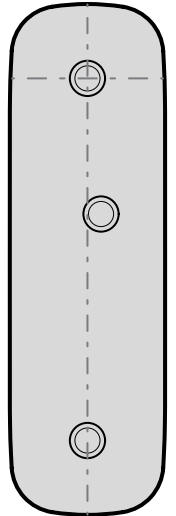

WT

1 Measure the TV fixing holes Width and Height

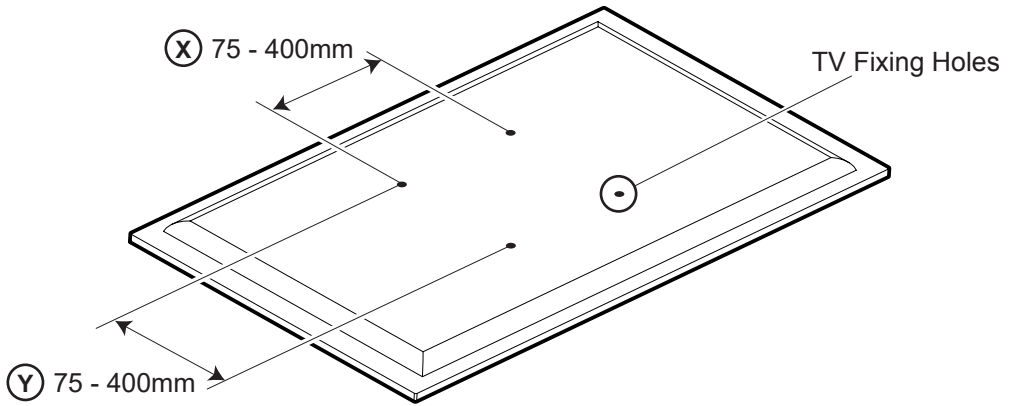

If width (X) is greater than 400mm or height (Y) greater than 400mm STOP installation now and contact the customer help line.

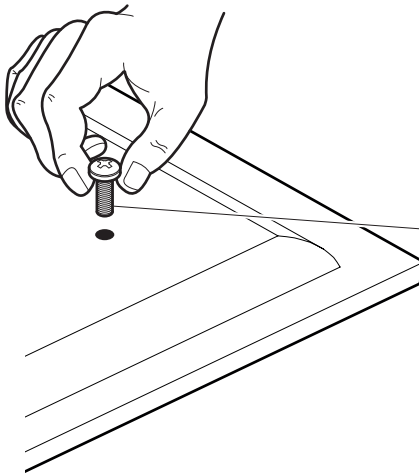

M4 = H1-H2

M6 = H3-H5

M8 = H6-H8

You are provided with 3 diameters of TV fixing screws **M4**, **M6** and **M8**. Determine the screw diameter that fits and remember for step 3.

2 Preparing the TV Mounting Plate

Use the option that fits your TV

OPTION 1

- (X) 75mm x (Y) 75mm
- (X) 100mm x (Y) 100mm
- (X) 100mm x (Y) 200mm
- (X) 200mm x (Y) 100mm
- (X) 200mm x (Y) 200mm

OPTION 2

- (X) 75mm - 400mm (Y) 75mm - 400mm

When attaching adaptors **C** you must always use **HOLES x4** and either of the **SLOTS**.

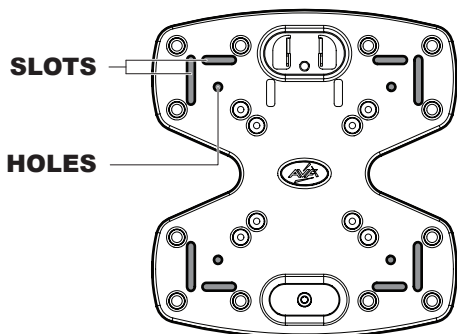

Before you fully tighten the TV mounting plate check that the mounting plate holes line up with the fixing holes on the back of your TV.

OPTION 1

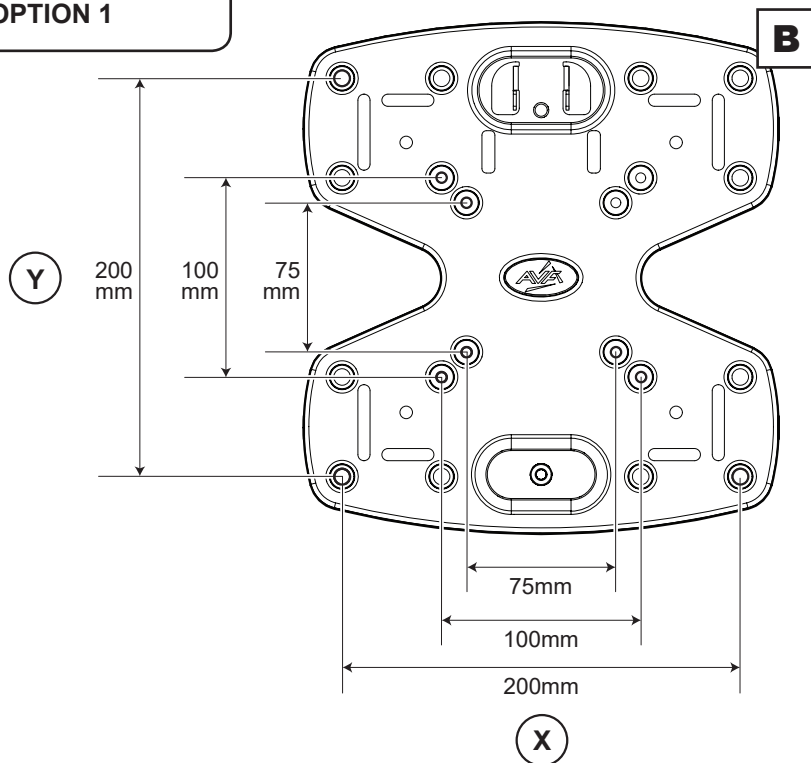

OPTION 2

Adaptors **C** can be fixed in different positions in the slots on Plate **B** to match your TV fixing holes.

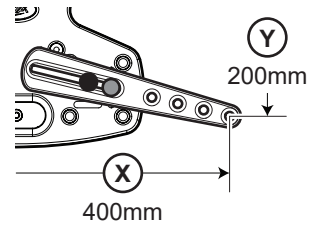
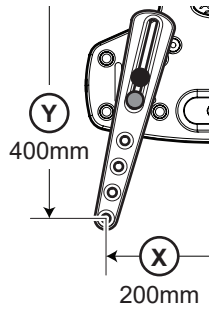
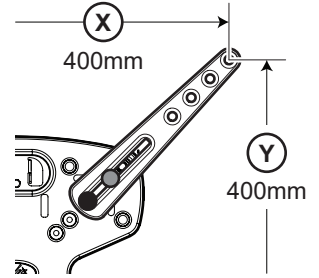
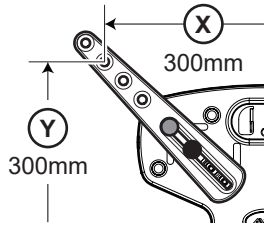
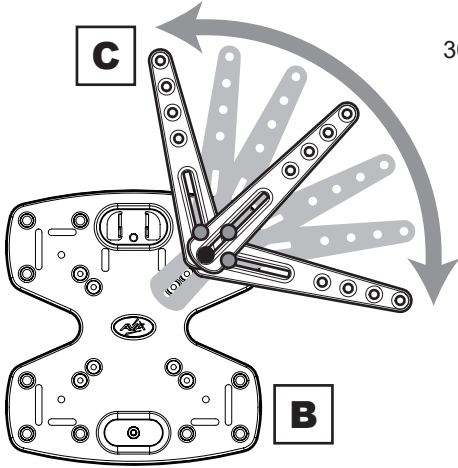

Top

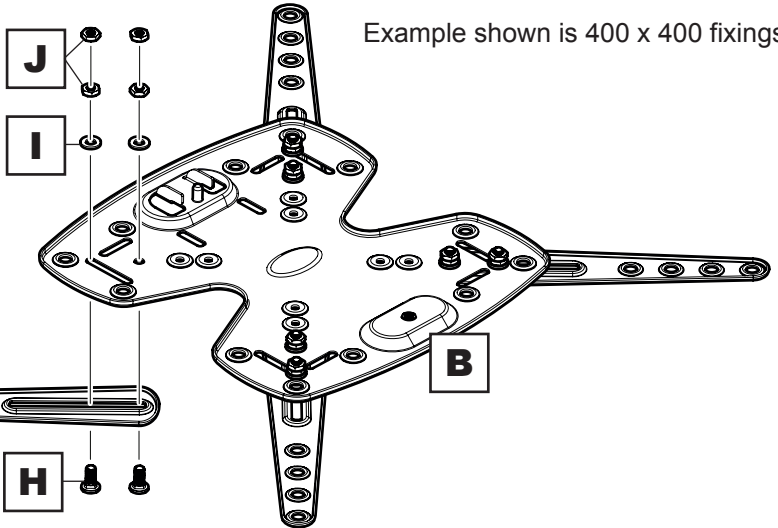

Example shown is 400 x 400 fixings



H x8 **I** x8 **J** x16

3 Fitting the TV Mounting Plate

No Spacers

For TVs with flat / unobstructed back.

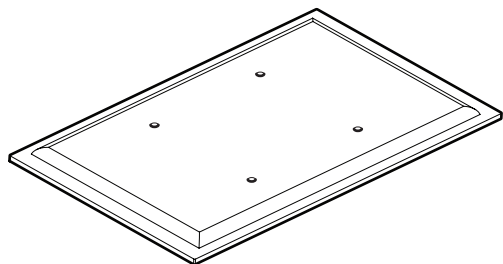

Spacers **M1/M2**

For TVs with irregular / obstructed back.

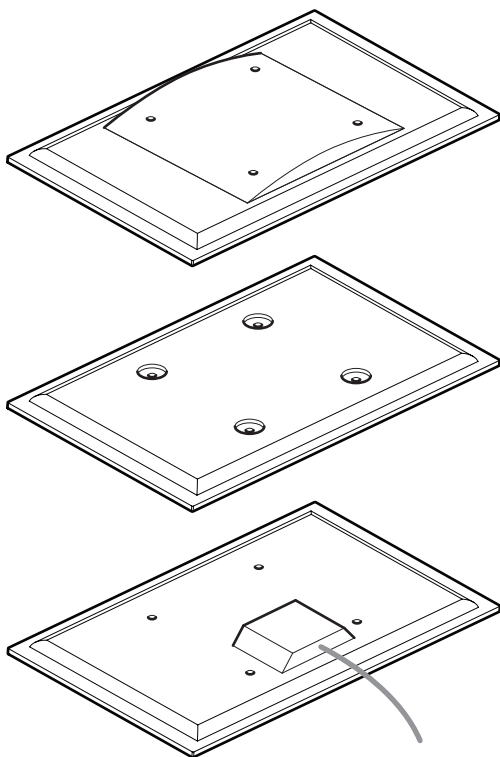

WARNING

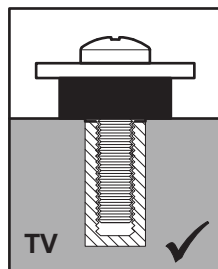
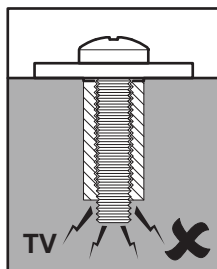
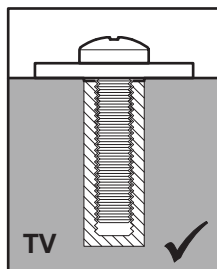
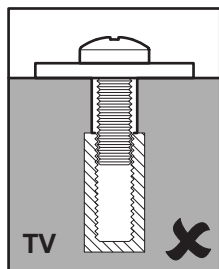

After completing step 3 you will have fittings left over, please keep for future reference.

Attach the bracket to the back of your TV using suitable screw, reducer and spacer combinations.

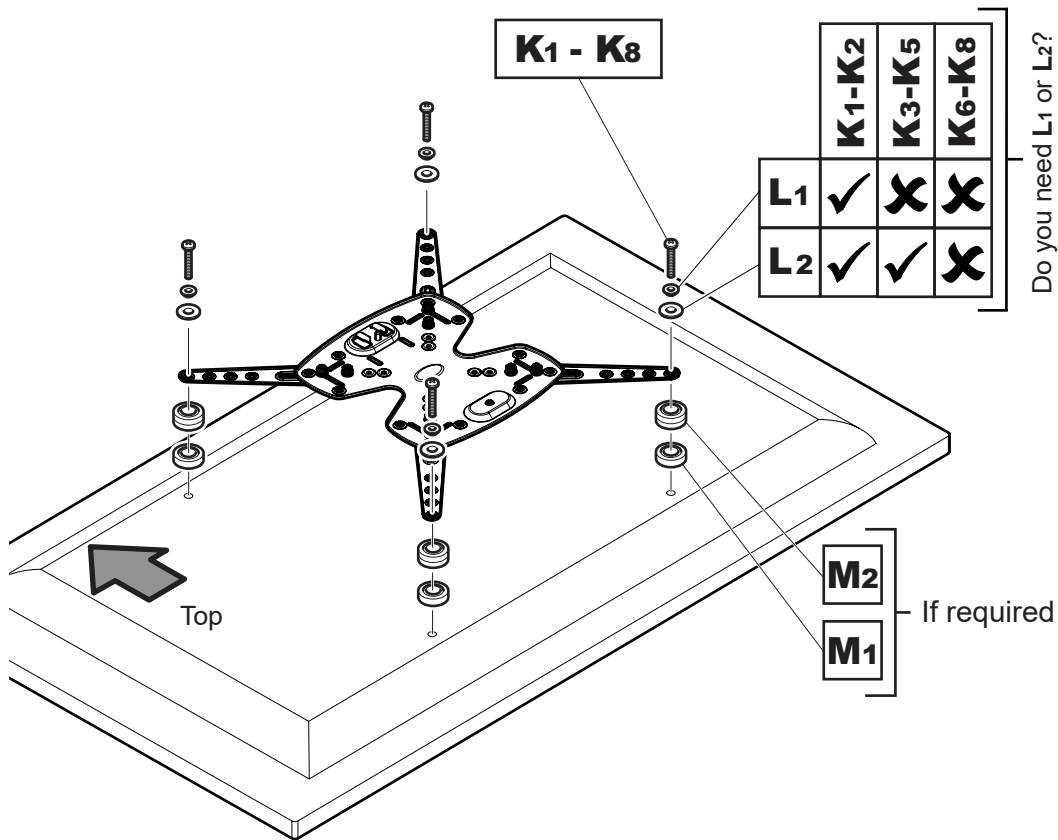

4 Fitting the Wall Bracket

Solid Wall

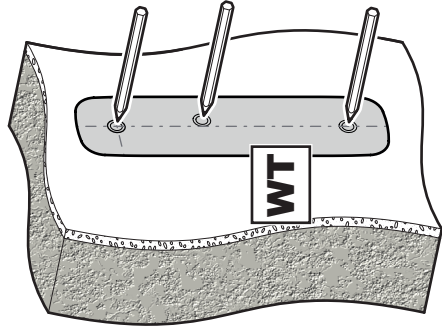

GET IT RIGHT

with our easy to use
online TV Height Calculator
at myTVmount.com

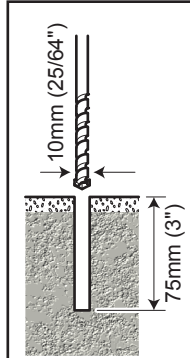

Remove Dust from Hole.

Wood Stud

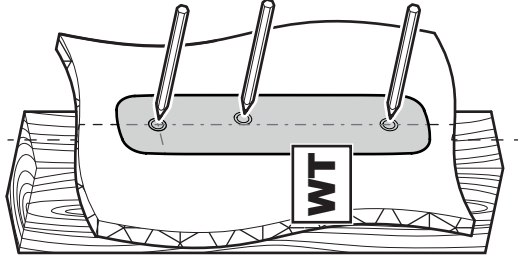

GET IT RIGHT

with our easy to use
online TV Height Calculator
at myTVmount.com

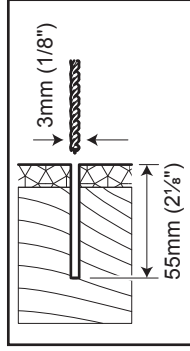

Ensure bracket is in the centre of the wood stud

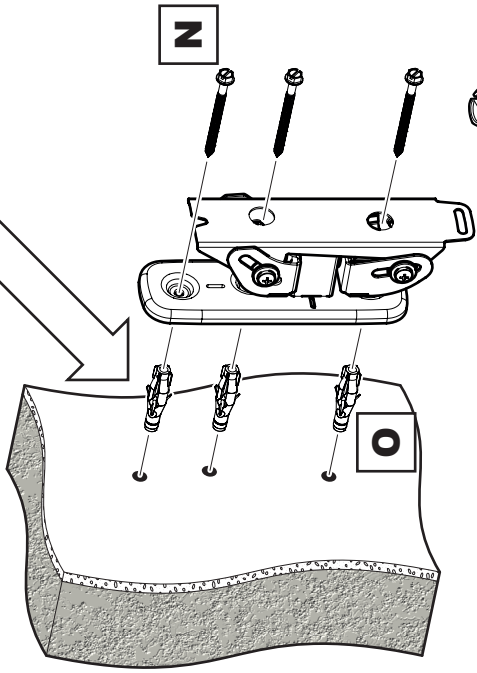
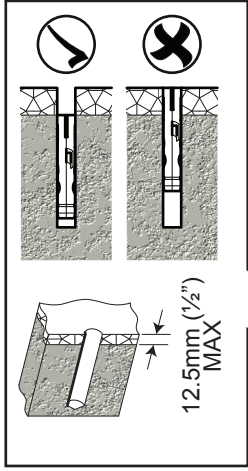

N x3

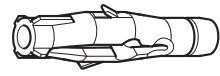

O x3



Lubricate screw thread with soap.



DO NOT overtighten screws.
Tighten screws by hand only.

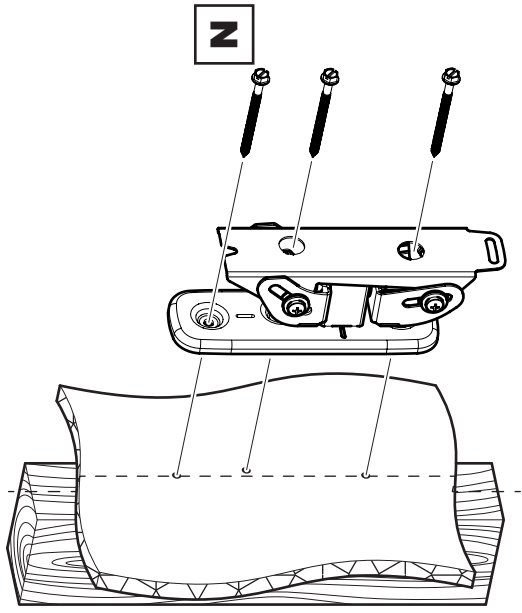

N x3



Lubricate screw thread with soap.



DO NOT overtighten screws.
Tighten screws by hand only.

5 Hanging the TV

Hanging the TV

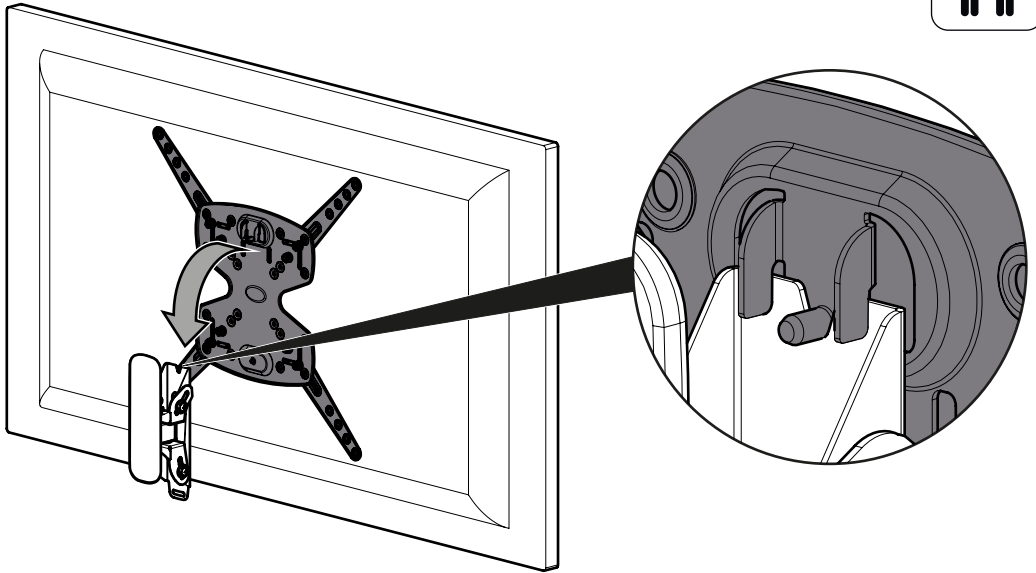

Locking the TV

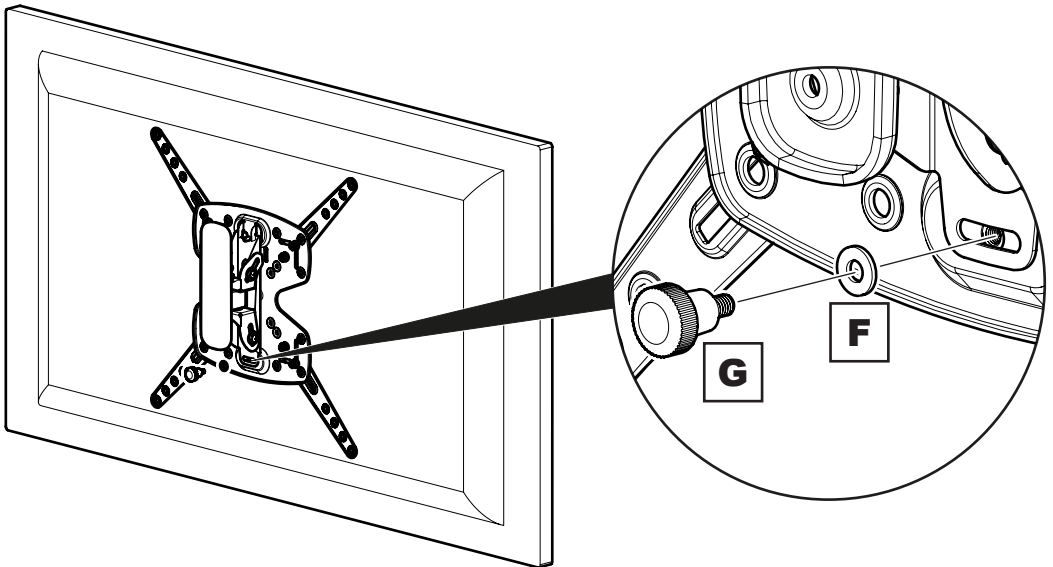

6 Tilt Adjustment

Adjust screws to achieve perfect tilt resistance if required.

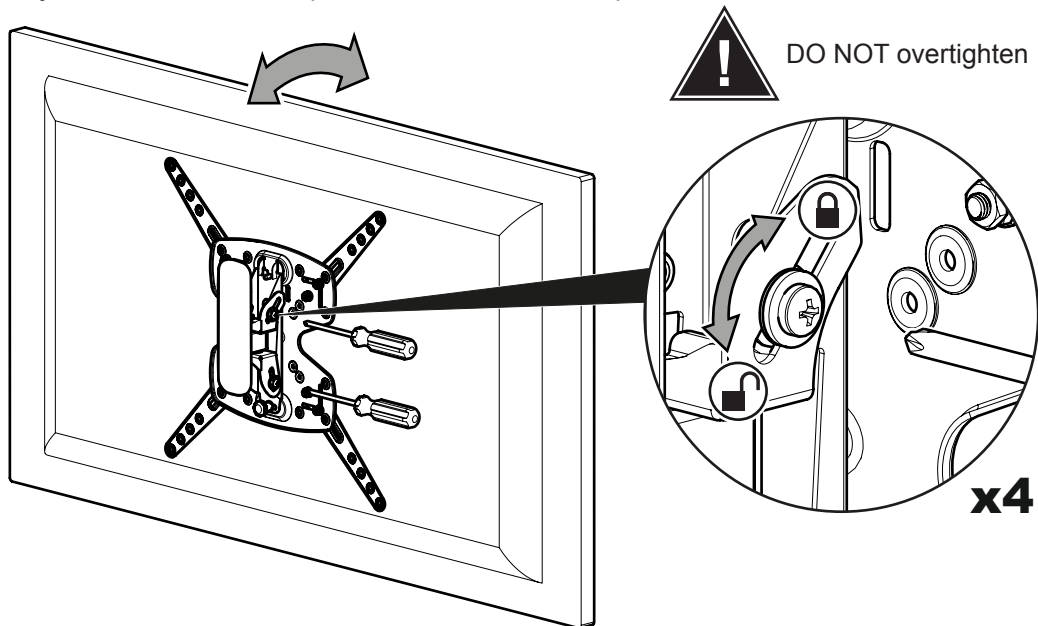

7 TV Levelling

