

jl.avfgroup.com

469016 rev02

JML8650

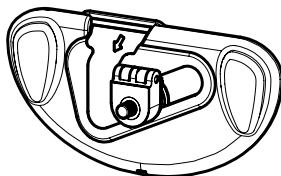
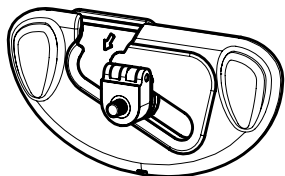

55kg
120lb

STOP

Read through **ALL** instructions before commencing installation.

If you have any questions about this product or issues with installation, contact the customer services helpline before returning this product to the store.

CUSTOMER SERVICES HELP LINE NUMBER: 0333 320 0463

AVF Group Ltd. Hortonwood 30, Telford, Shropshire, TF1 7YE, England

Assembly Overview

Fit Screen Hangers to TV

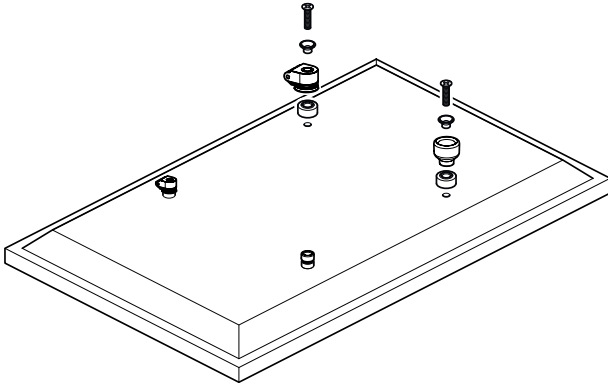

Fitting the Wall Bracket

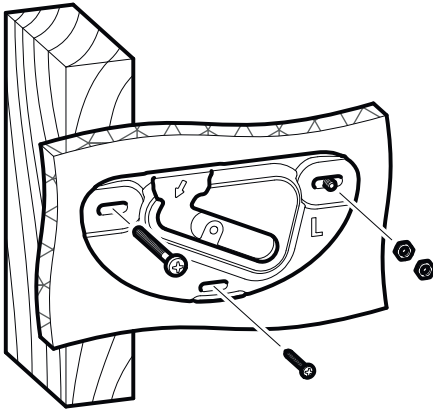

Hanging the TV

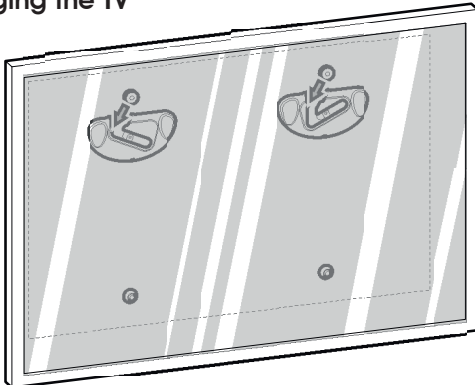

Tools Recommended



Stud Finder



Ø5.5mm (7/32") Masonry



Ø10mm (25/64") Masonry



Ø3.5mm (9/64") Metal



Ø3mm (1/8") Wood

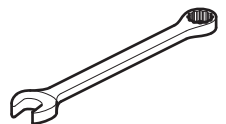
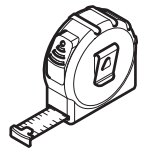
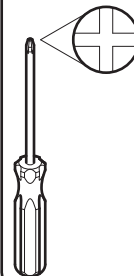
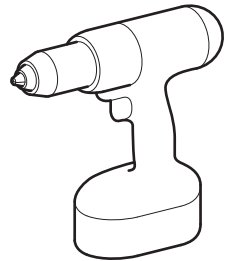
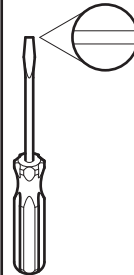

Index

1 Measure the TV fixing holes Width and Height

2 Fit Screen Hangers to TV

3 Marking Wall for Drill Points

4 Fitting the Wall Bracket

5 Fitting the Wall Bracket Covers

6 Hanging the TV

Retain all packaging in case the product needs to be returned.

Contents may vary from photography / illustrations.

You will not need all these parts, so expect there to be some left over depending upon the specification of your TV.

This product is intended for indoor use only. Use of this product outdoors could lead to failure and personal injury.

It is the responsibility of the installer to ensure that the mounting wall is of a suitable standard and void of any services (eg gas, electricity, water etc).

AVF accept no responsibility for any damage or loss caused by installing this product in a substandard wall.

Boxed Parts

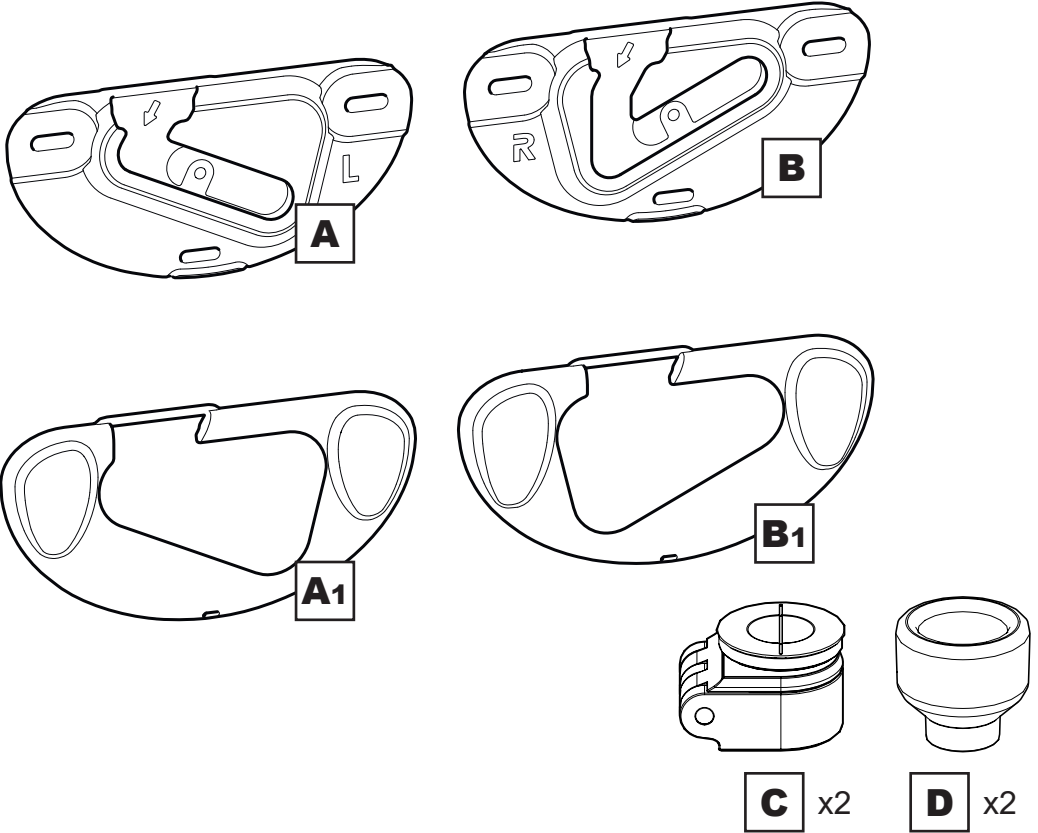

TV Screws, Reducers and Spacers

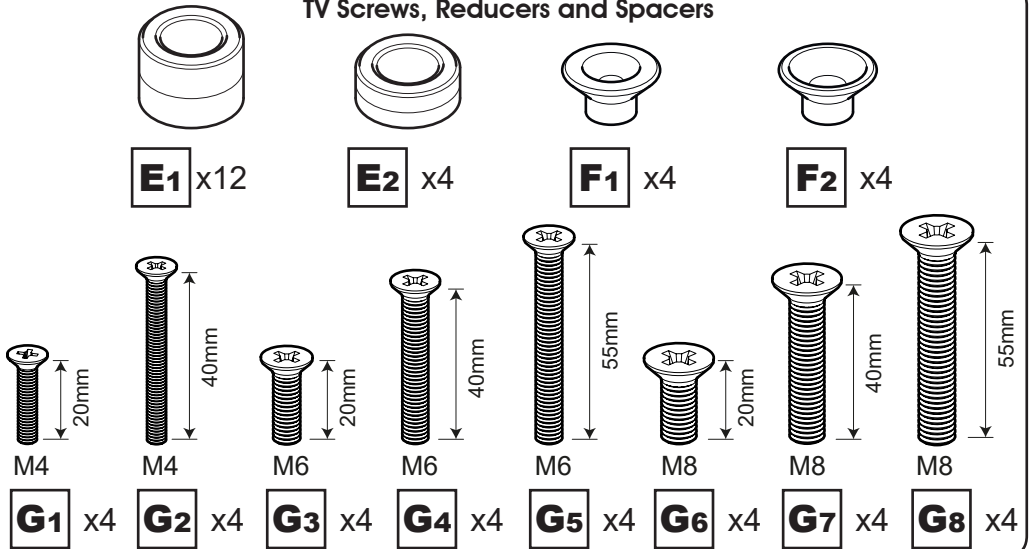

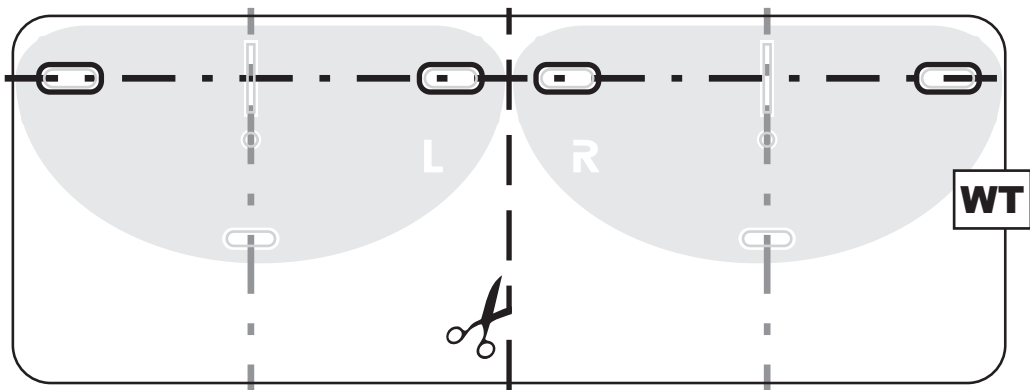
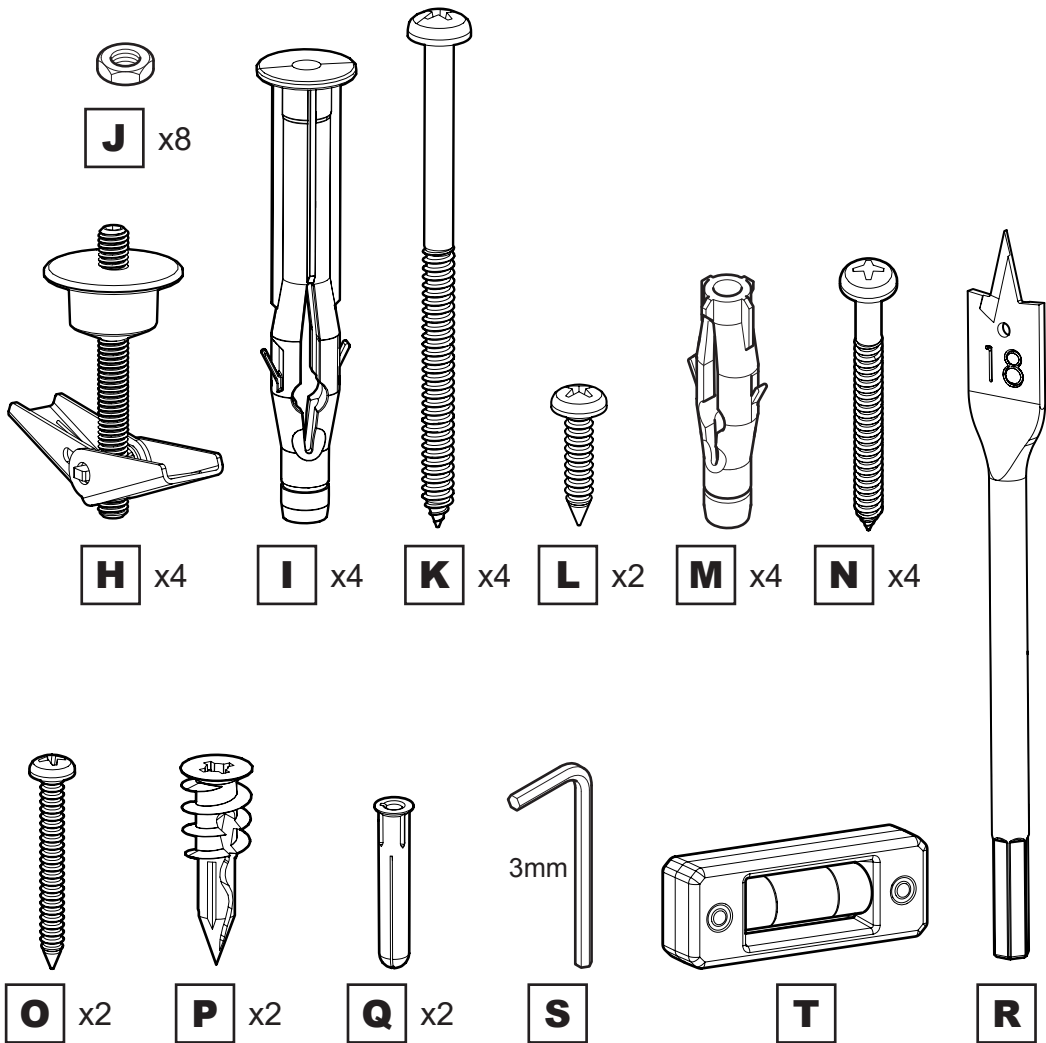

Remove the Wall Bracket Covers and keep for step 7

Wall bracket covers **A1** and **B1** are removed in the same way.

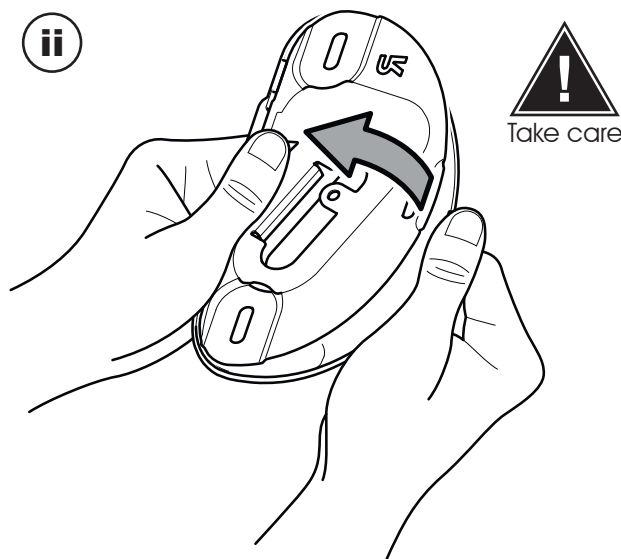
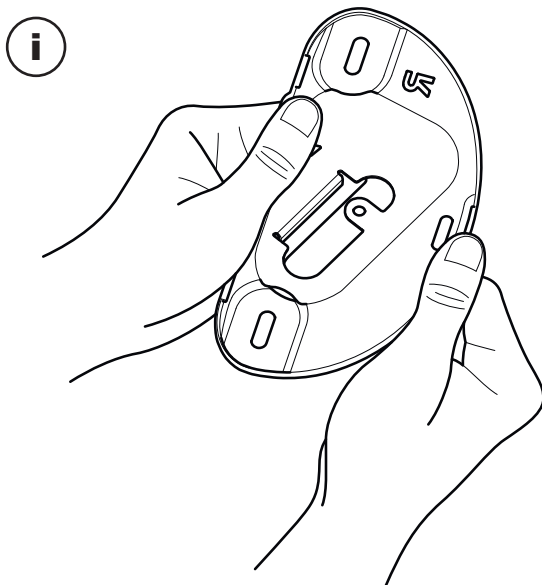

1 Measure the TV fixing holes Width and Height

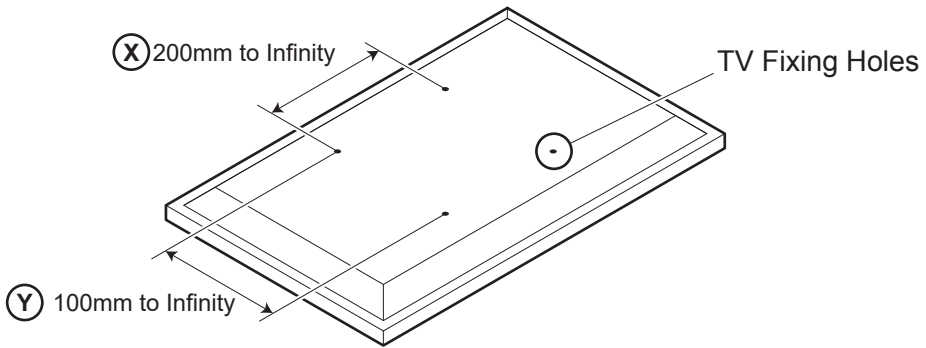

If width **X** is less than 200mm or height **Y** less than 200mm STOP installation now and contact the customer help line.

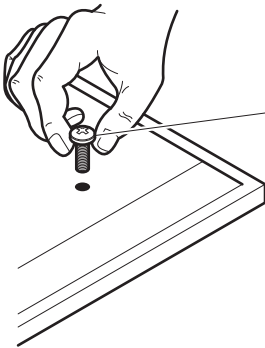

M4 =	G1/G2
M6 =	G3/G4/G5
M8 =	G6/G7/G8

You are provided with 3 diameters of TV fixing screws, **M4**, **M6** and **M8**. Determine the screw diameter that fits and remember for step 2



After completing step 2 you will have fittings left over, please keep for future reference.

2 Fit Screen Hangers to TV

Once you have established which screw diameter you need for your TV you will need to choose which wall spacing you require. Check the back of your TV and use the OPTION that fits your TV. Please see page opposite for more details.

OPTION 1

25mm Wall Space

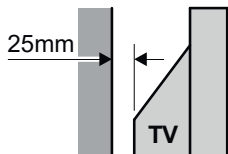

Suitable for TVs with a flat back and no obstructions

OPTION 2

35mm Wall Space

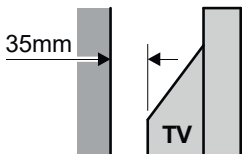

Suitable for TVs with small to medium obstructions eg power supply, mouldings etc

OPTION 3

55mm Wall Space

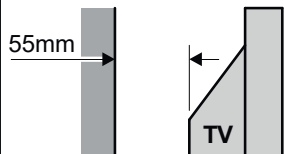

Suitable for TVs with large obstructions eg power supply, mouldings etc

Top Fixings

G1-G8

If required **F1-F2**

C

* If required **E1**

Close **C** after assembly

Bottom Fixings

G1-G8

If required **F1-F2**

D

If required * **E1**

Top

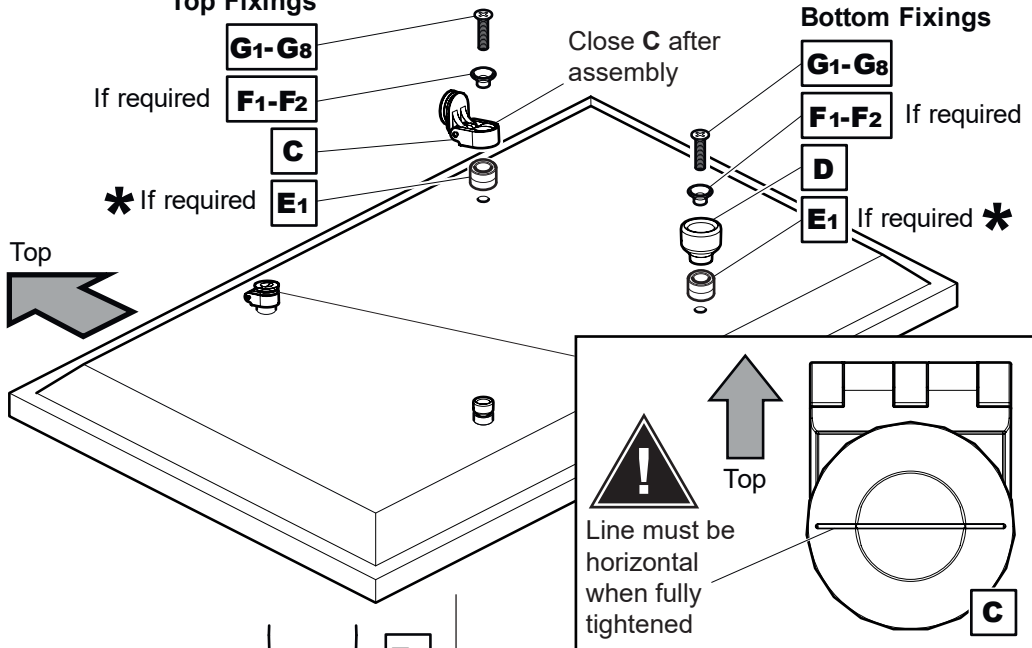

Problem
Not enough screw engagement

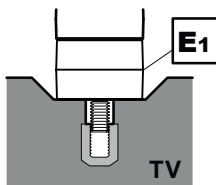

Solution
Red spacer **E2** has replaced spacer **E1**

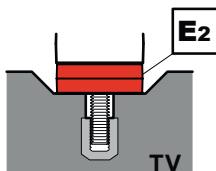

In certain circumstances it may be necessary to use red spacer **E2** as either a replacement or addition to spacer **E1**.

When is it necessary to use red spacers **E2**?

It is recommended that when fitting Hangers **C** and Stand-offs **D** to your TV you have at least 5-10mm of screw engagement. In certain circumstances you may need to use red spacers **E2** as either a replacement, or together with spacers **E1** to achieve this. Whenever you use red spacers **E2** you must use all 4 provided.

OPTION 1

25mm Wall Space

Top Fixings

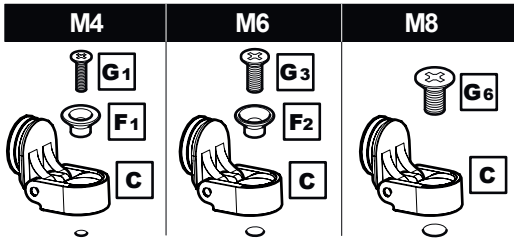

Bottom Fixings

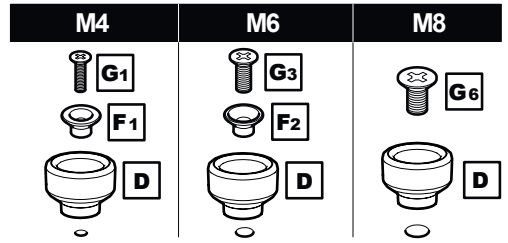

OPTION 2

35mm Wall Space

Top Fixings

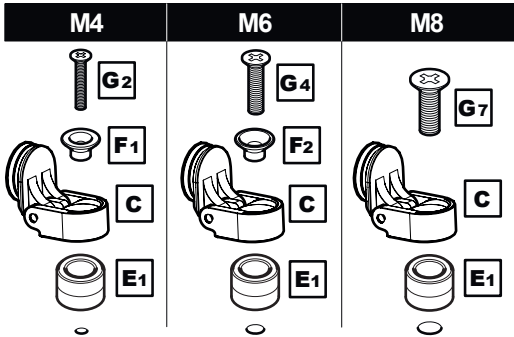

Bottom Fixings

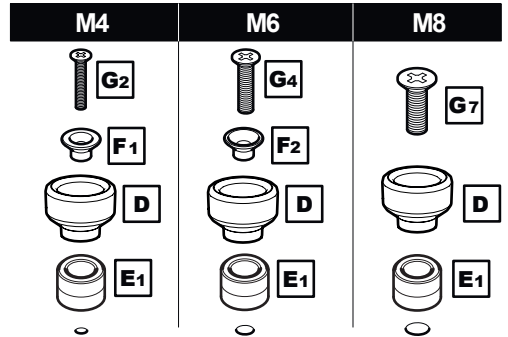

OPTION 3

55mm Wall Space

Top Fixings

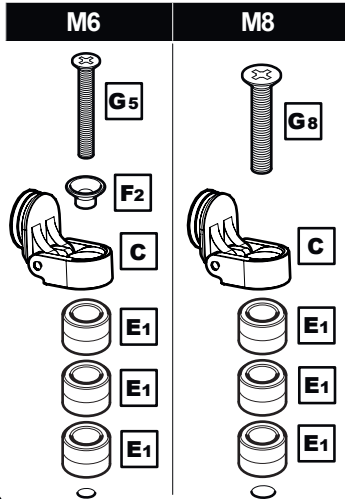

Bottom Fixings

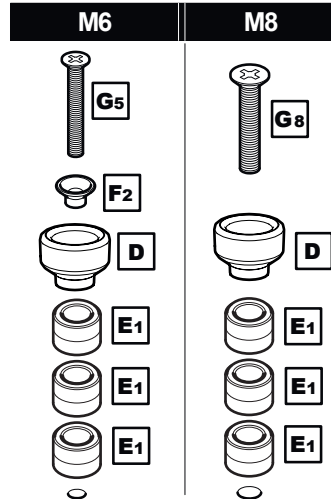

3 Marking Wall for Drill Points



For this step you will need your Wall Marking Template **WT**.

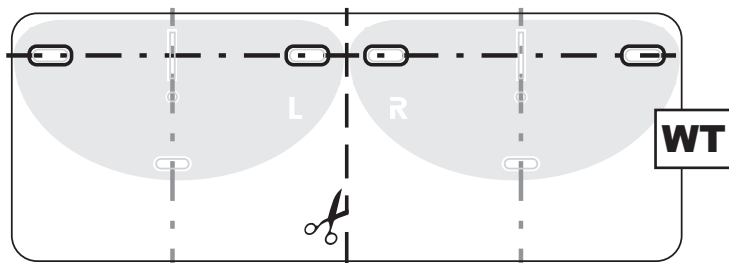

Use the Height Calculator app to achieve your desired TV height. Follow the link to the app shown on your Wall Marking Template.



Before marking the wall, determine the wall type that you have (i.e. Solid Wall/ Dot & Dab/Plasterboard/Wood Stud/Metal Stud). Ensure the drilling area is free from mains services (Gas/Electric/Water).



The Height Calculator app will give you the correct height to mark a horizontal line on your wall.



Mark a vertical line on the wall where you want the centre of your TV to be.

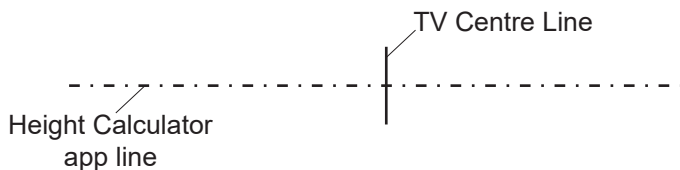

Measure the distance between the top two fixing holes on the back of your TV. Halve this number and mark a vertical line, this distance, either side of the TV Centre line on your wall (e.g. if the fixing holes are 400mm apart, measure 200mm either side of the TV Centre line).

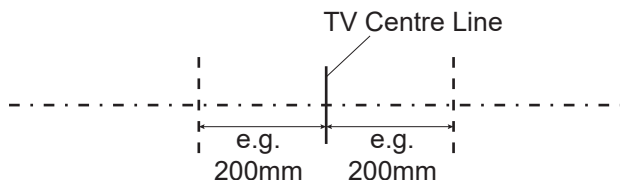
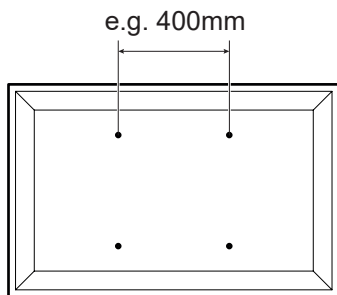

iv

Cut your Wall Marking Template along the dotted centre line. Place each half on the wall so the lines on the template match the lines marked on your wall. Mark the drill points as shown.

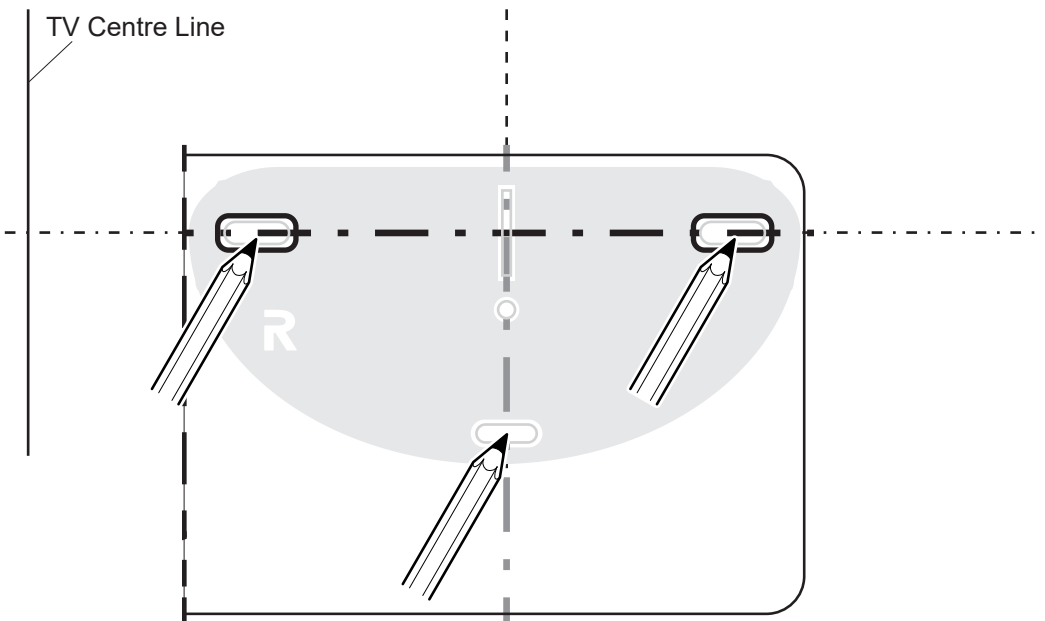
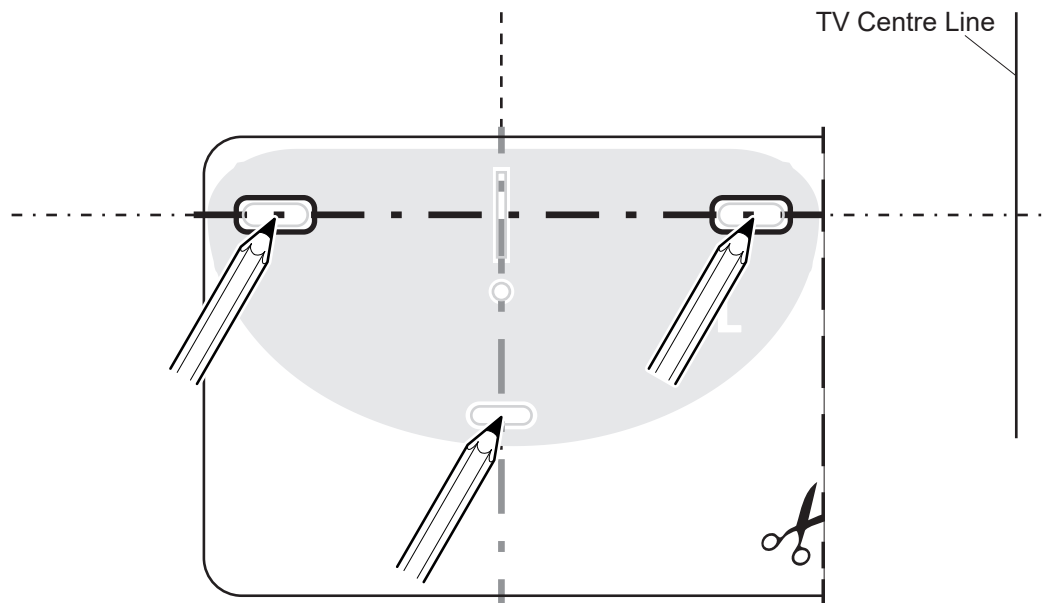

i

Before you drill make sure you are happy with the position and ensure all markings are correct and level.

4 Fitting the Wall Bracket

Use the correct fixings for your wall type. Mixing fixing types may be required for installations that span different wall types. DO NOT OVER TIGHTEN SCREWS.

Solid Wall

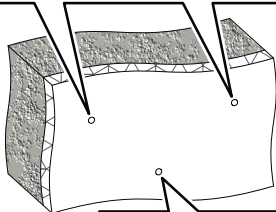
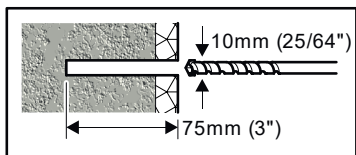

Remove dust from holes

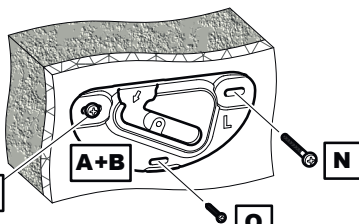
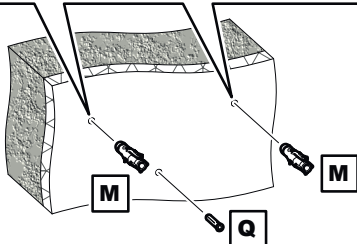
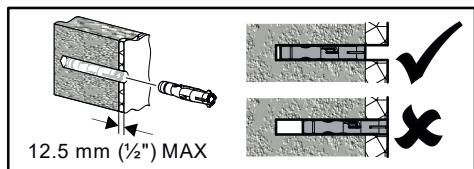
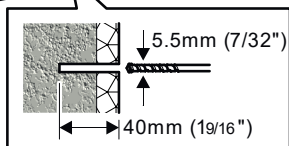

Lubricate screw thread with soap

Dot & Dab

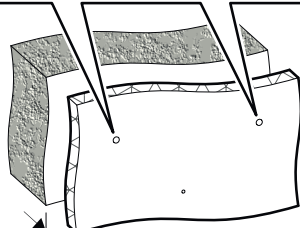
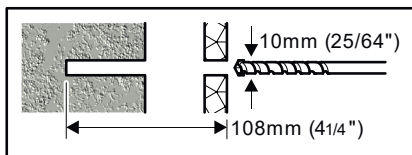

* 40mm (1 9/16") MAX gap

* If gap is above 40mm (1 9/16) use plasterboard fixing method



Remove dust from holes

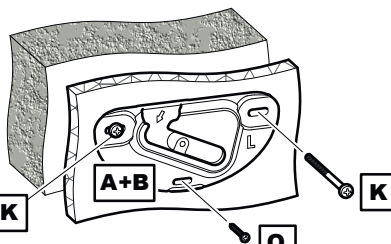
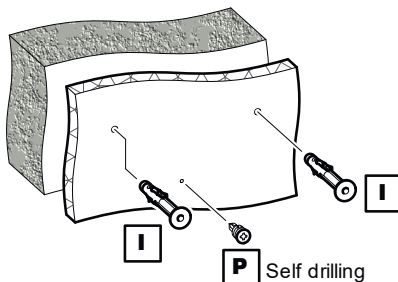

Lubricate screw thread with soap

Plasterboard

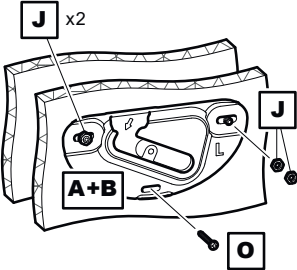
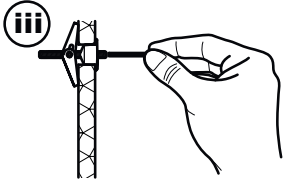
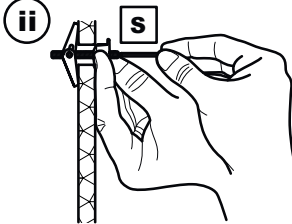
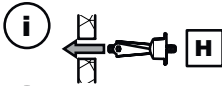
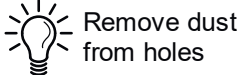
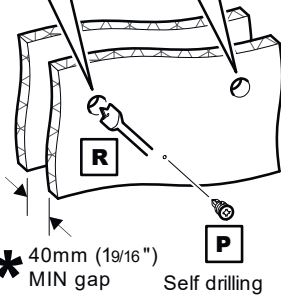
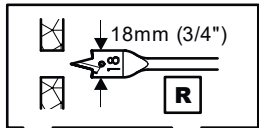

Wood Stud

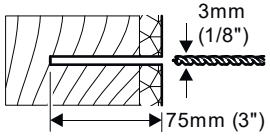
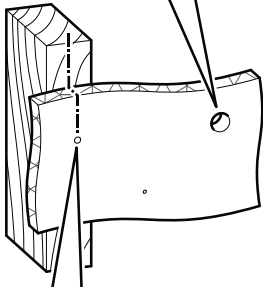
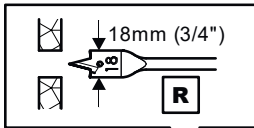

Ensure hole is in the middle of the wood stud

Use Plasterboard Fixing H

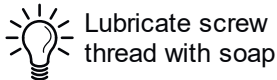
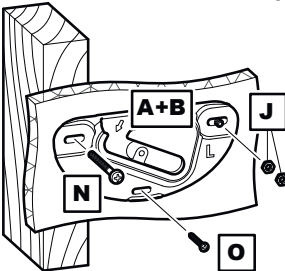
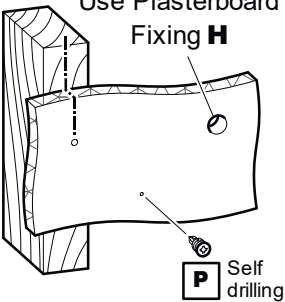

Only one fixing will be in the wood stud. The other fixings will be in plasterboard (see above)

Metal Stud

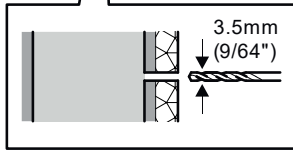
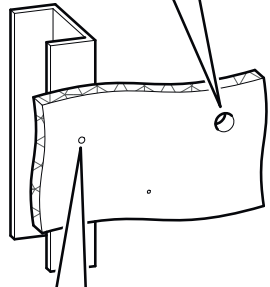
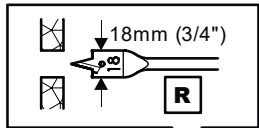

Use Plasterboard Fixing H

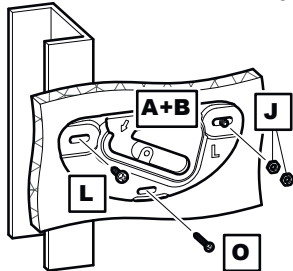
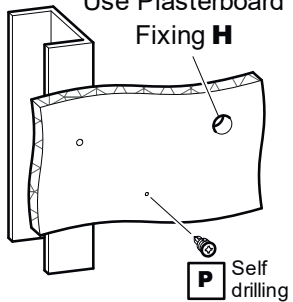

Only one fixing will be in the metal stud. The other fixings will be in plasterboard (see above)

5 Fitting the Wall Bracket Covers

On wall bracket covers **A1** & **B1** are 3 retaining tabs. These locate onto 3 retaining lips on wall brackets **A** & **B** and lock the wall bracket covers in position.

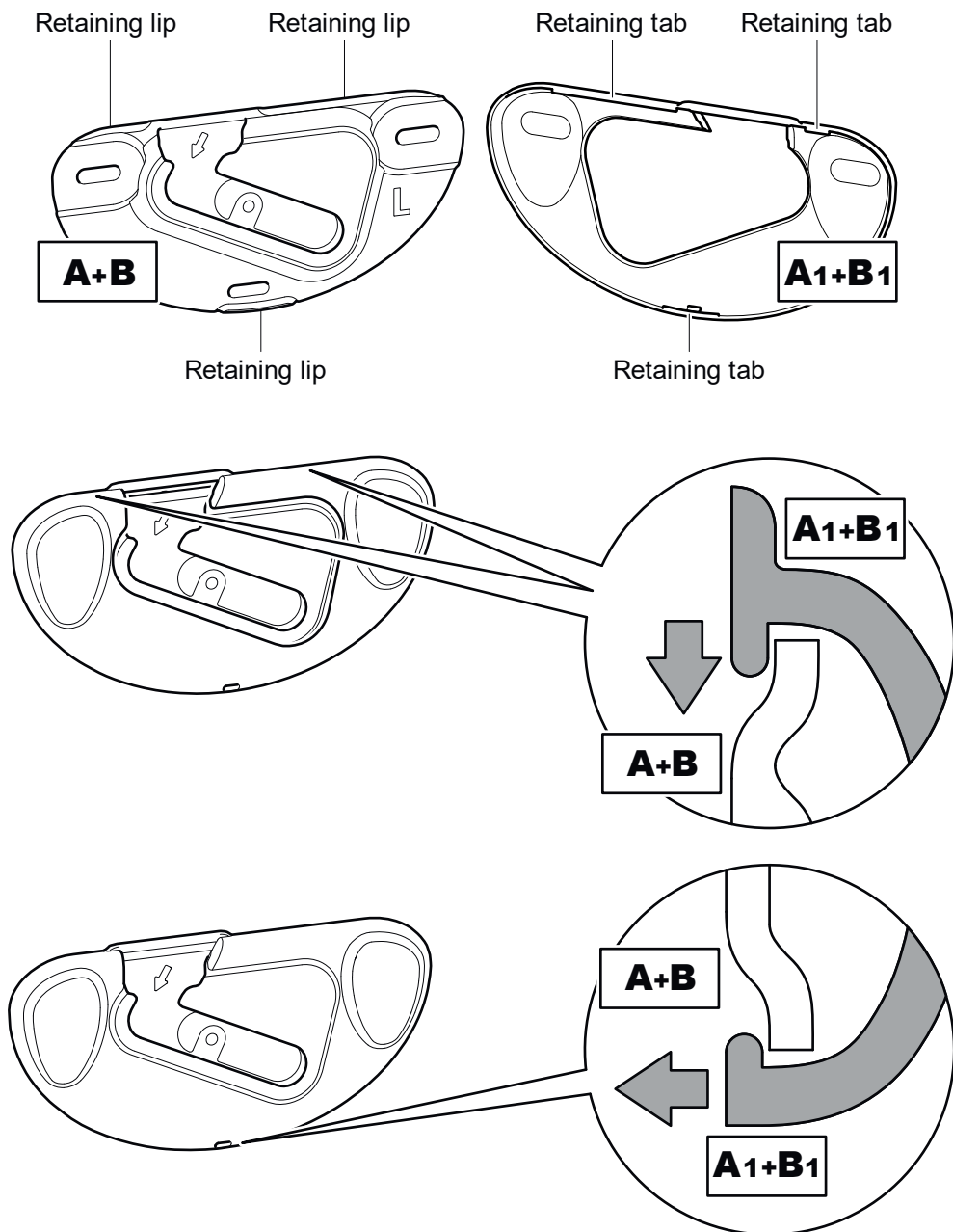

6 Hanging the TV

Present hangers **C** (on the back of the TV) to the opening on brackets **A** & **B**. Slide down and across into place. Ensure both hangers are fully engaged. If cables from the TV prevent the TV resting against the wall then an alternative hanger configuration will be required (see section 2). TV must be parallel to wall. Use spacers / stand-offs as shown in section 2.

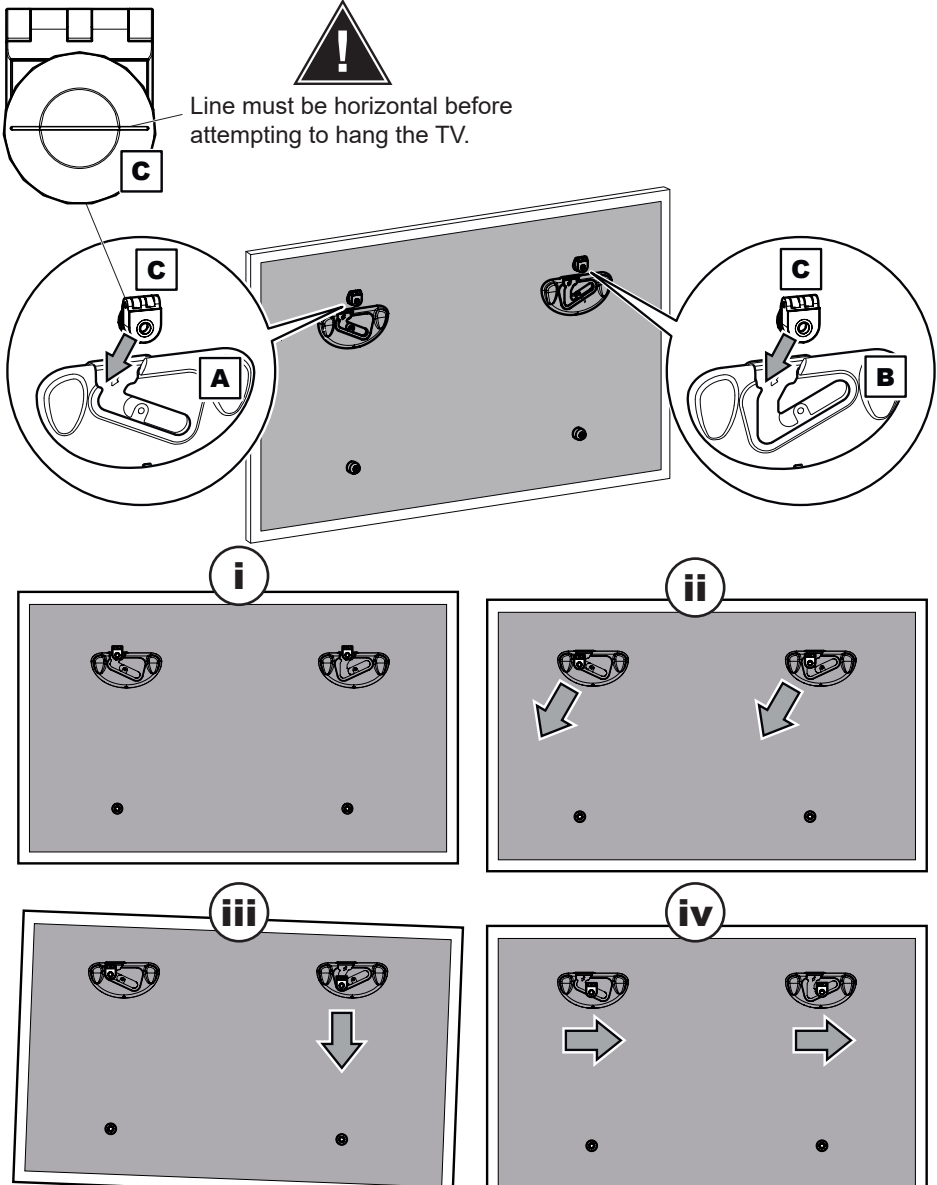

Removing the TV

To remove the TV reverse the movements as shown above.

Removing the Wall Bracket Covers

Should you want to remove the wall bracket covers please follow the steps below.

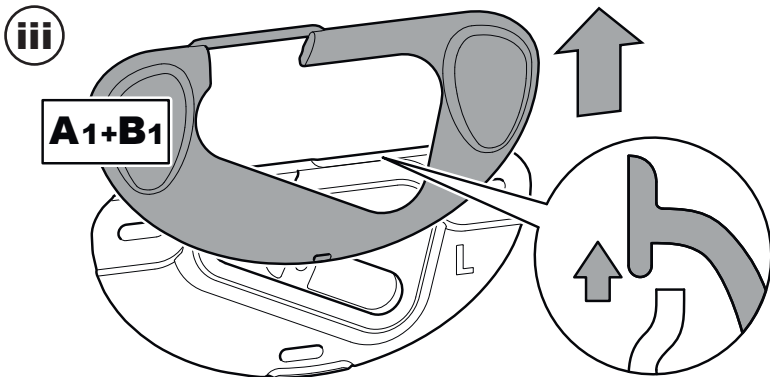
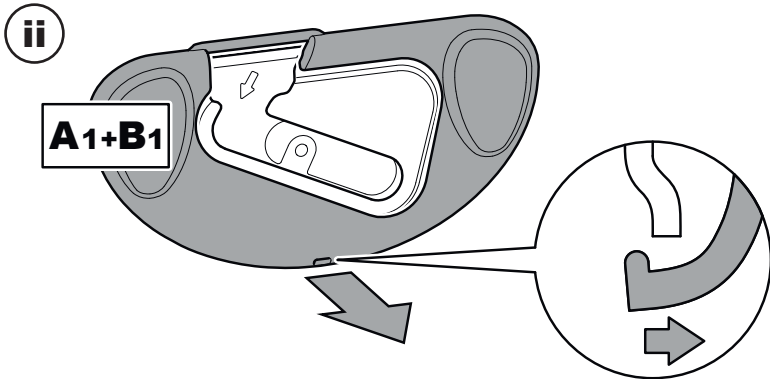
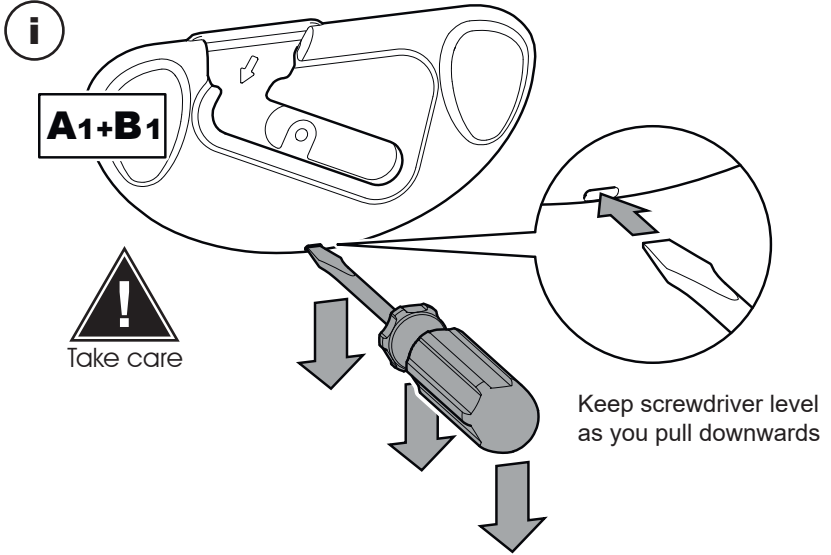

Cable Access

For easy cable access, gently pull the bottom of the TV away from the wall using two hands. Hold the TV in position while accessing cables. When finished gently lower the TV back to against the wall.

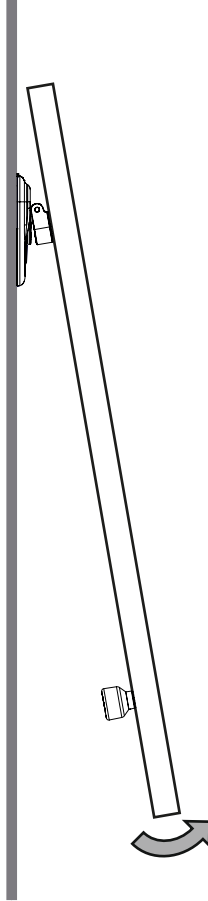

Stop before the top of the TV touches the wall.

