

468586 rev00

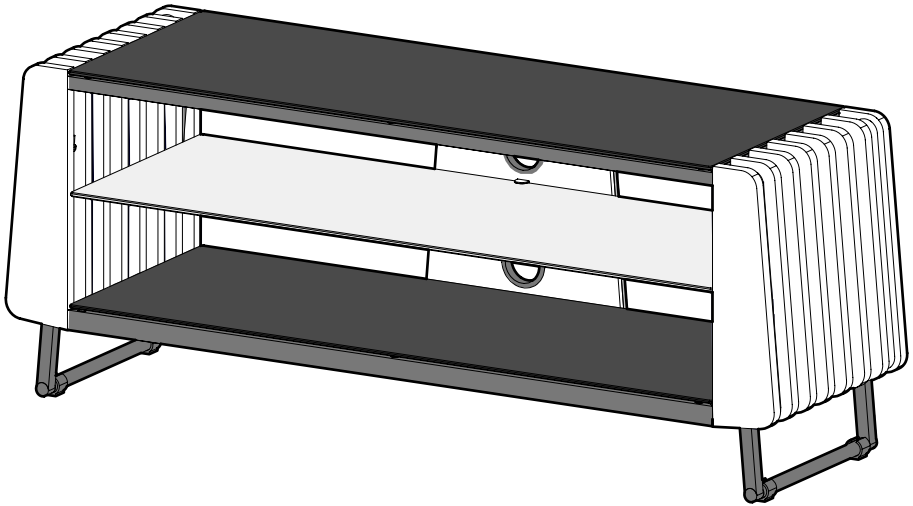

www.avfgroup.com

45 kg
99 lbs

STOP

Read through **ALL** instructions before commencing installation.

If you have any questions about this product or issues with installation, contact the customer services help line before returning this product to the store.

**ARRETEZ
-VOUS**

Lisez **TOUTES** les instructions avant de débiter l'installation.

Si vous avez des questions sur ce produit ou des problèmes d'installation, contactez l'assistance client avant de ramener le produit en magasin.

ALTO

Lea **TODAS** las instrucciones antes de comenzar la instalación.

Si tiene alguna pregunta sobre el producto o problemas con la instalación, llame a la línea de servicio al consumidor antes de devolverlo.

CUSTOMER SERVICES HELP LINE NUMBER: **+44 (0) 333 320 0463 (UK)**

NUMÉRO DE L'ASSISTANCE CLIENT:

NUMERO DE SERVICIO DE ATENCION AL CLIENTE: **1-800 667 0808 (USA)**

IMPORTANT INFORMATION!

We advise that before starting the assembly of this product that you familiarise yourself with the instructions and the parts list in this leaflet.

INFORMATIONS IMPORTANTES!

Nous vous recommandons de vous familiariser avec ces instructions et la liste des pièces détachées contenues dans ce document avant de commencer l'assemblage de ce produit.

INFORMACIÓN IMPORTANTE!

Le recomendamos que antes de comenzar el ensamblaje de este producto se familiarize con las instrucciones y la lista de partes en esta hoja informativa.

Do not's

Do not over tighten any part of this assembly.

Do not place hot or cold objects on to or close next to any glass surface unless the object is sufficiently insulated to prevent contact.

Do not strike the glass with hard or pointed items.

Do not sit or stand upon horizontal glass surfaces.

Do not use washing powders or other substances containing abrasives when cleaning the glass.

À ne pas faire

Ne serrez pas trop fort aucun des éléments de cet assemblage.

Ne placez aucun objet froid ou chaud sur ou à proximité de toute surface en verre à moins que celui-ci ne présente une isolation suffisante pour empêcher tout contact.

Ne frappez pas les surfaces en verre avec des objets lourds ou pointus.

Ne vous asseyez ni ne montez pas sur les surfaces horizontales en verre.

N'utilisez pas de poudre à récurer ou toute autre substance abrasive lorsque vous nettoierez les surfaces en verre car cela risquerait de provoquer des rayures.

No haga

No apriete demasiado ninguna de las piezas de este soporte.

No coloque objetos calientes o fríos en o cerca de cualquier superficie de vidrio, a menos que el objeto esté aislado para prevenir contacto directo.

No golpee el vidrio con artículos fuertes o punzantes.

No se sienta o se pare en superficies de vidrio.

No use detergentes para lavar u otras sustancias que contengan abrasivos cuando esté limpiando el vidrio ya que estas pueden rayarlo.

Do's

Do use a damp cloth with diluted washing up liquid for cleaning the glass surfaces.

Check all nuts and bolts from time to time.

À faire

Utilisez un chiffon humide imprégné de liquide vaisselle dilué pour le nettoyage des surfaces en verre.

Vérifiez tous les écrous et les boulons de temps à autre.

Si haga

Use un trapo suave con líquido diluido en agua para limpiar las superficies de vidrio.

Compruebe todos los tornillos y tuercas de vez en cuando.

Maximum TV weight and shelf capacities

Poids maximal du téléviseur et capacité de charge de l'étagère

Máximo peso y capacidad del estante de TV

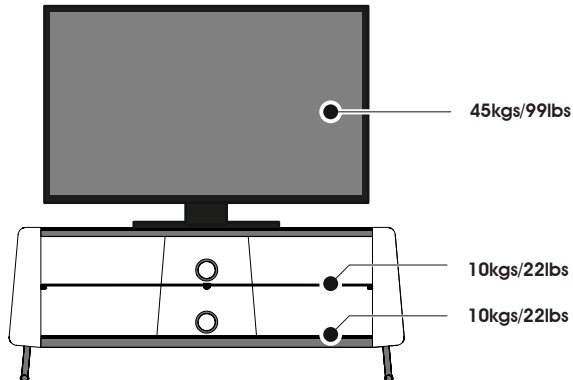

WARNING: Wherever possible distribute weight evenly.

AVERTISSEMENT: Répartissez le poids de manière uniforme lorsque cela est possible.

ADVERTENCIA: En la medida de lo posible distribuya el peso uniformemente.

Height and Colour Options
Options de hauteur et de couleur
Opciones de color y altura

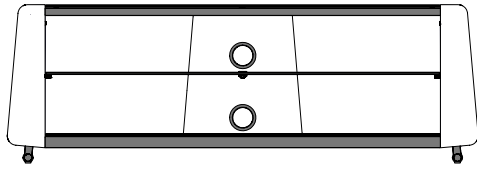

400mm

Low
Faible
 Bajo

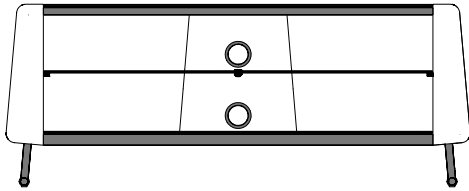

475mm

Medium
Moyen
 Medio

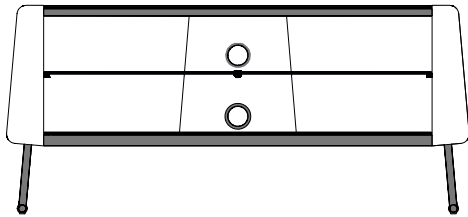

550mm

High
Haute
 Alto

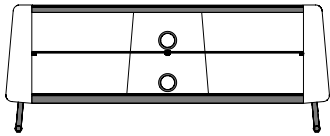

White
Blanc
 Blanco

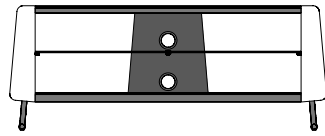

Walnut
Noyer
 Nuez

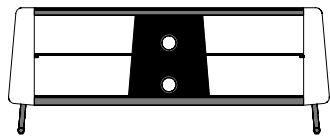
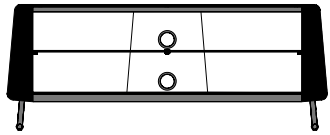

Black
Noir
 Negro

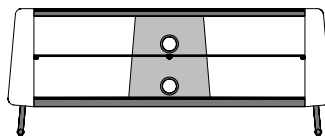
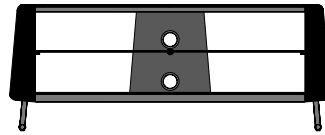

Oak
Chêne
 Roble

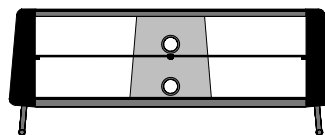
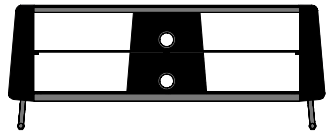

Boxed Parts
Pièces empaquetées
Piezas en la Caja

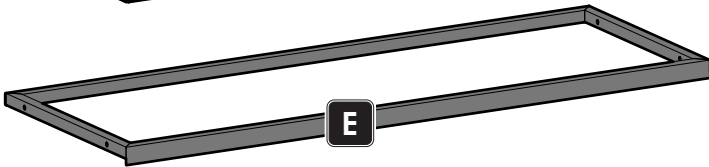
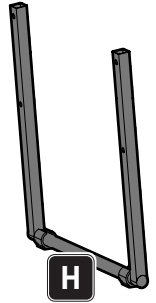
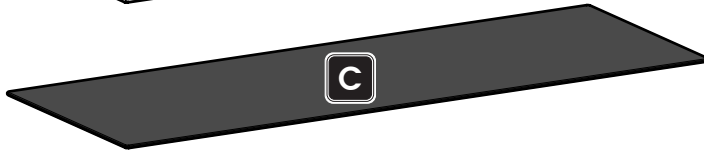
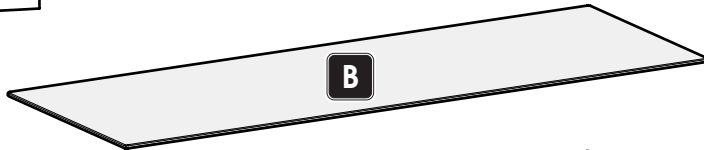
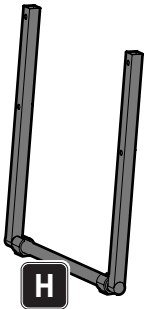
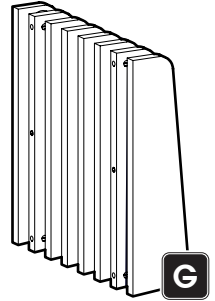
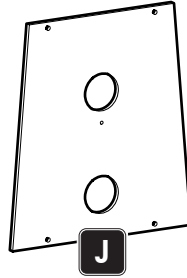
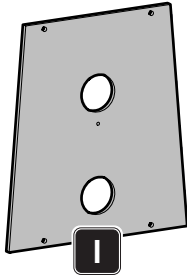
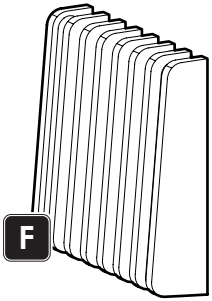
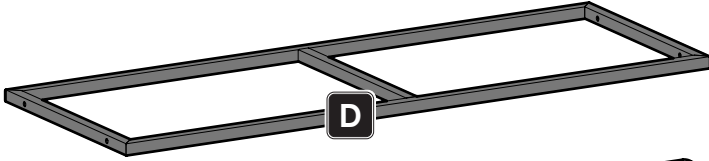
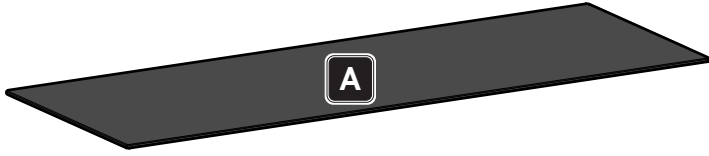

Tools Recommended
Outils recommandés
Herramientas recomendadas

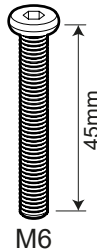
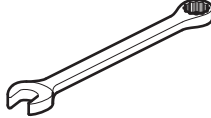
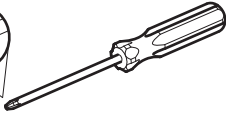

K
X8

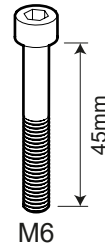

L
X8



M
X13

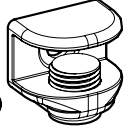

N
X1



M4

O
X1

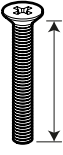

M4

P
X1



Q
X4

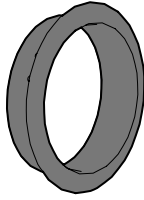

R
X2



S
X1



T
X4

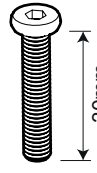

M6

U
X4



4mm

V
X1

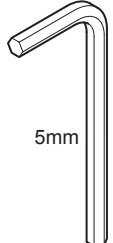

5mm

X2
X1

1

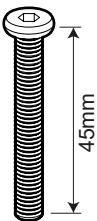
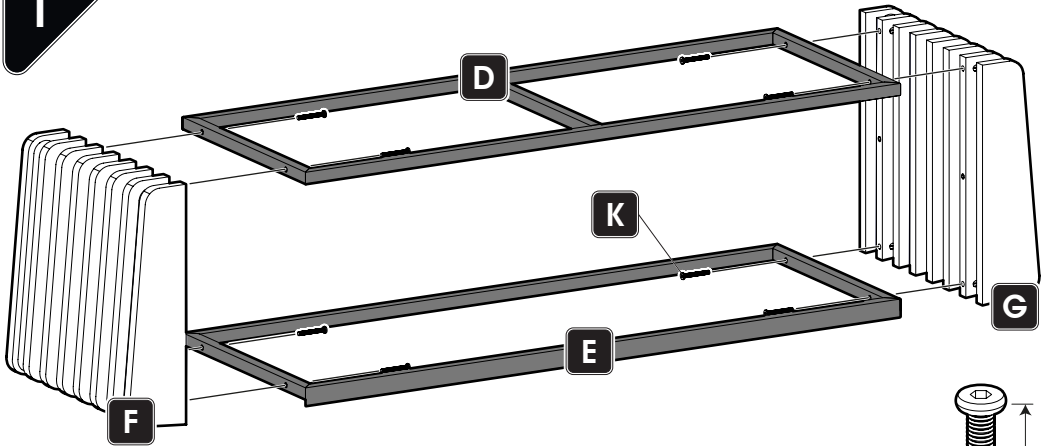

M6

K
X8



Take care not to drag when moving. Lift using metal frame only.
 Veuillez à ne pas glisser lorsque vous bougez. Soulevez à l'aide d'un cadre métallique seulement.
 Evitar arrastrar en movimiento. Levantar únicamente con un marco metálico.

2

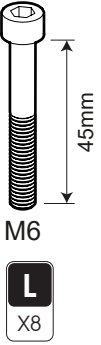
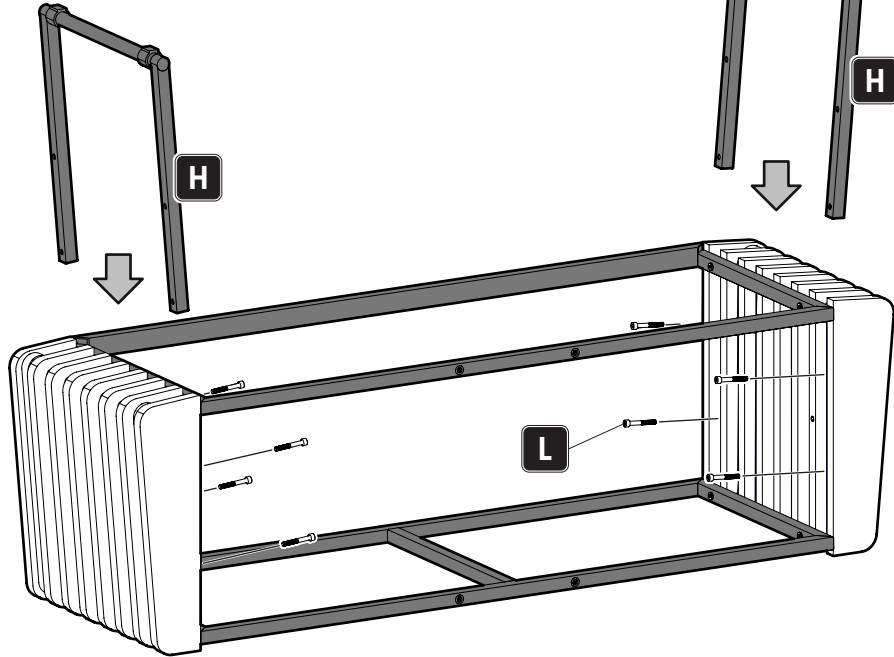

Each leg must be secured by four screws.
Chaque pied doit être fixé par quatre vis.
Cada pata debe estar sujeta con cuatro tornillos.

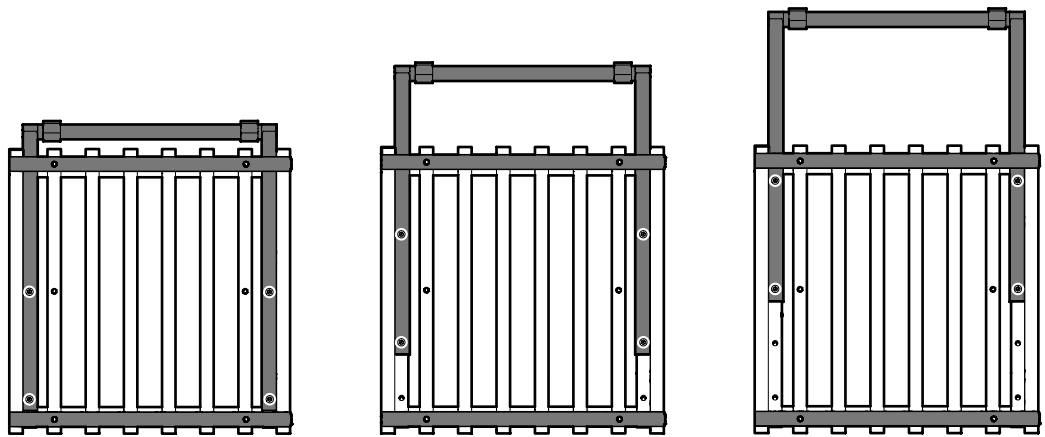

Low
Faible
Bajo

Medium
Moyen
Medio

High
Haute
Alto

3

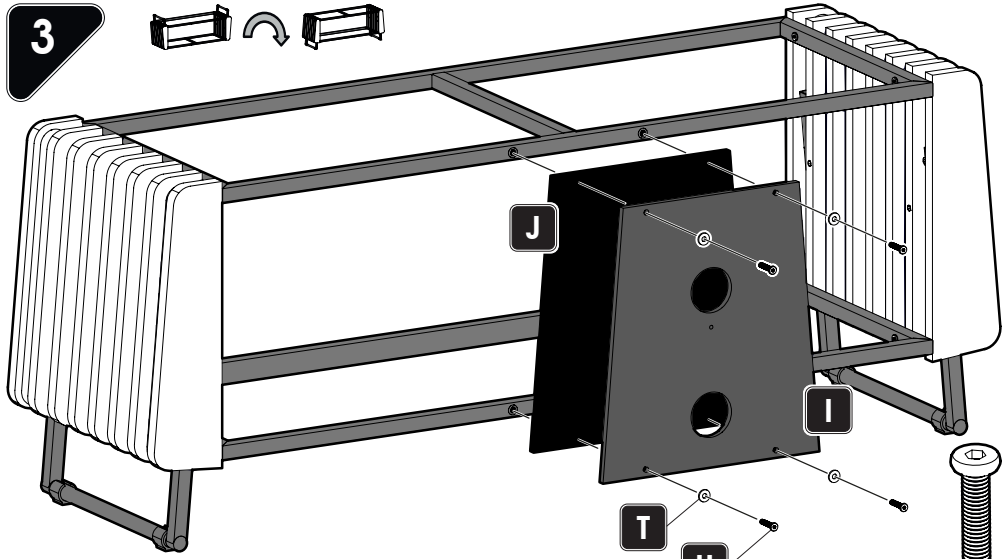

T
U

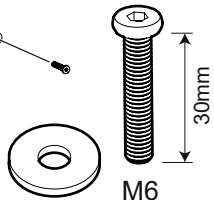

30mm

M6

T
X4

U
X4

4

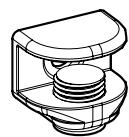
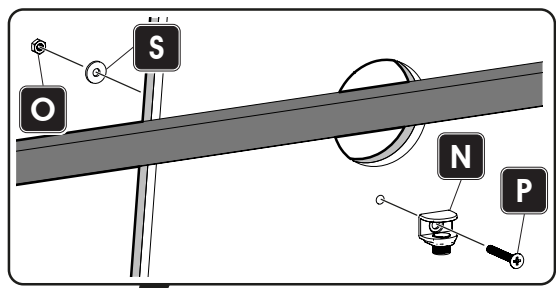

N
X1



S
X1

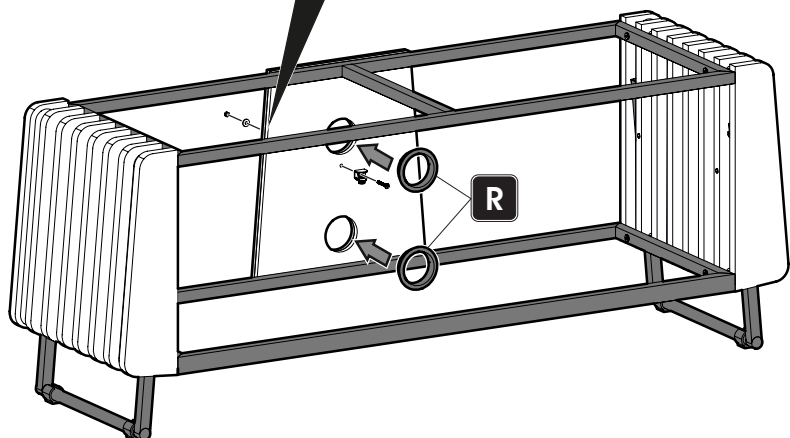

R

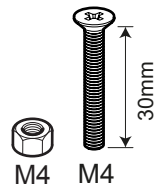

M4

M4

30mm

O
X1

P
X1

5

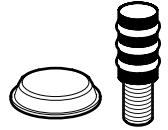
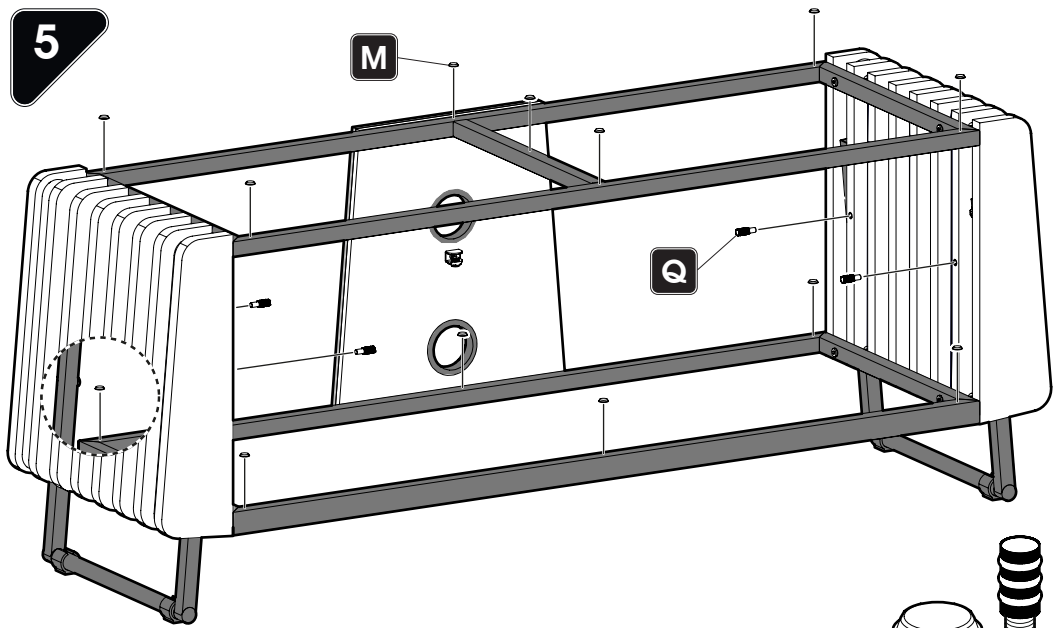

M
X13

Q
X4

6

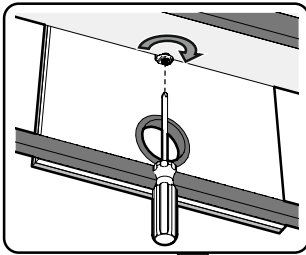

DO NOT overtighten
Ne serrez pas trop fort
 No apriete demasiado

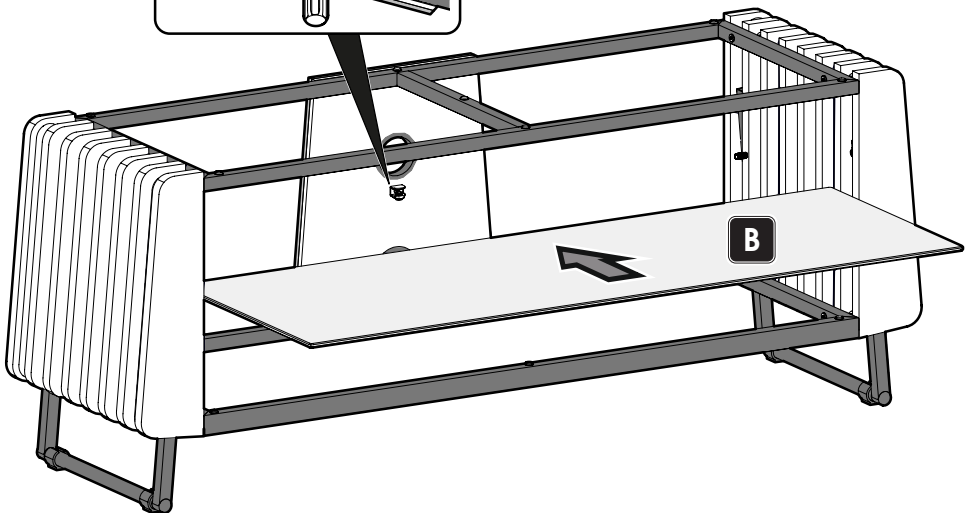

7

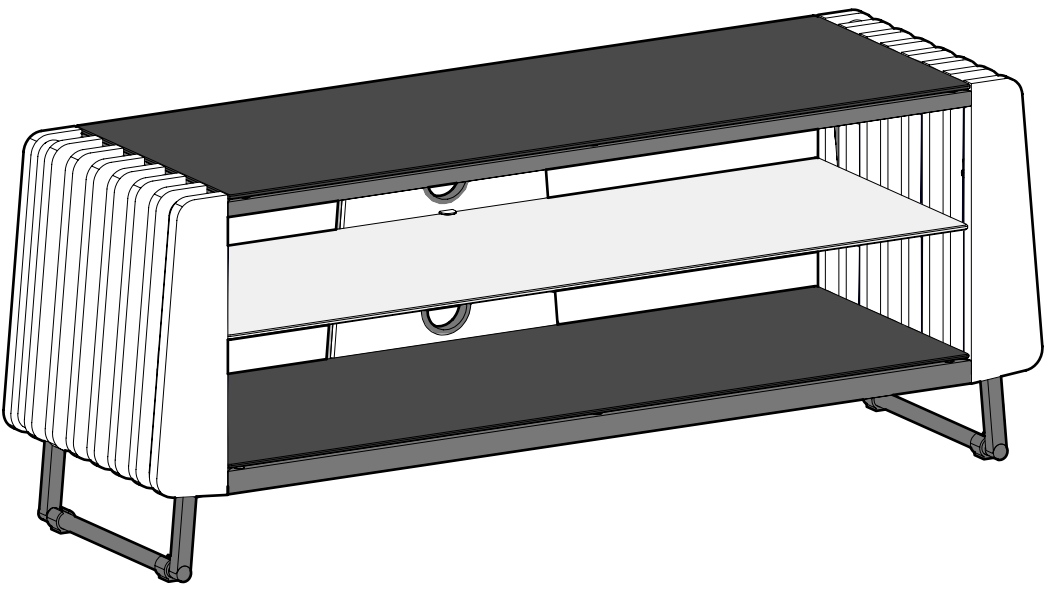
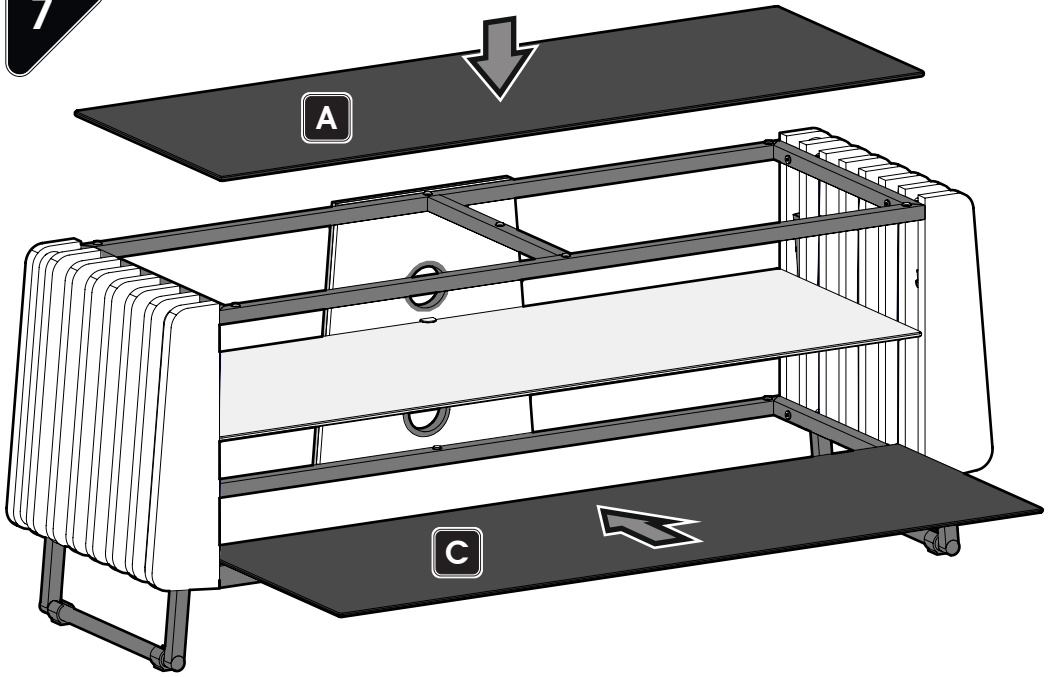

Change Colour Options
Changer les options de couleur
Cambiar las opciones de color



Remove all glass shelves before starting.
Retirez toutes les étagères en verre avant de commencer.
Extrae todas las estanterías de vidrio antes de empezar.

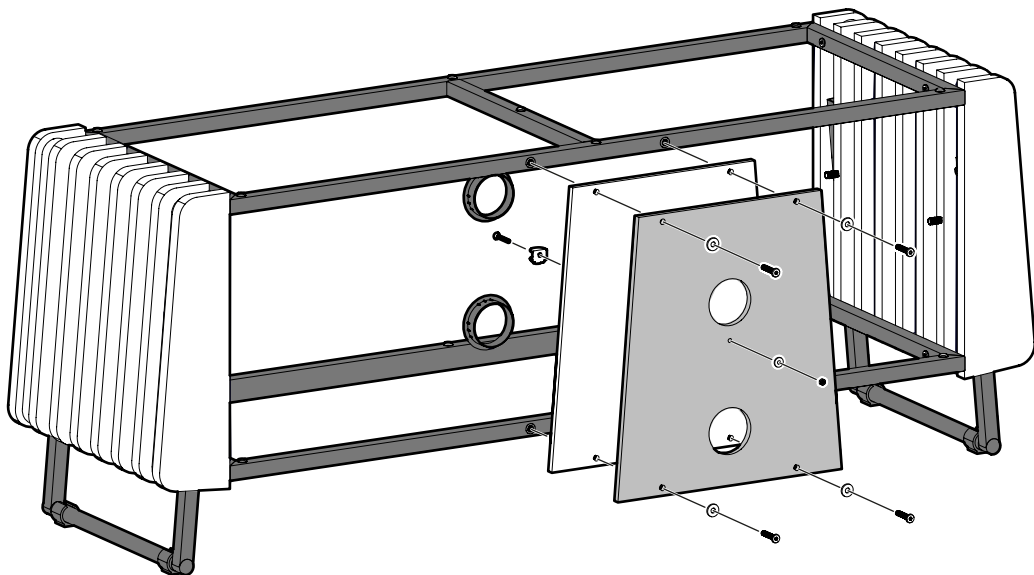

Remove trim panels and rotate to select preferred colour option.
Retirez les panneaux de finition et faites-les pivoter pour sélectionner l'option de couleur préférée.
Elimina los paneles de recorte y gira para seleccionar la opción de color preferido.



You must replace both trim panels.
Vous devez remplacer les deux panneaux de finition.
Debes reemplazar los dos paneles de recorte.

Change Height Options
Modifier les options de hauteur
Cambiar las opciones de altura



Remove all glass shelves before starting.
Retirez toutes les étagères en verre avant de commencer.
Extrae todas las estanterías de vidrio antes de empezar.



Each leg must be secured by four screws.
Chaque pied doit être fixé par quatre vis.
Cada pata debe estar sujeta con cuatro tornillos.

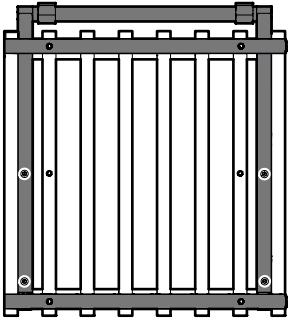

Low
Faible
Bajo

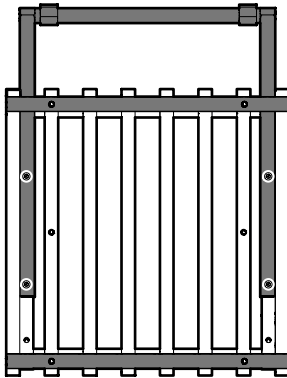

Medium
Moyen
Medio

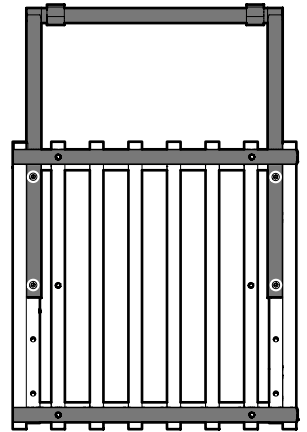

High
Haute
Alto

