

CML8350-E

English Language

Leaflet No. 464397 rev00

##

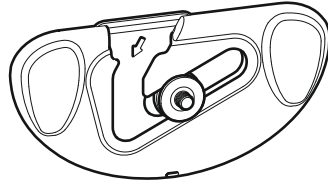
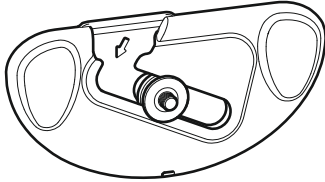

Read through ALL instructions before commencing installation.
If you have any questions about this product or issues with installation
contact the customer services help line before returning this product to
the store. See www.cus.avfgroup.com/p/CML8350-A

CUSTOMER SERVICES HELP LINE NUMBER:

1-800 667 0808 (USA)



AVF Incorporated. 3187, Cornerstone Drive, Eastvale, CA 91752, USA

Assembly Overview

Fit Screen Hangers to TV

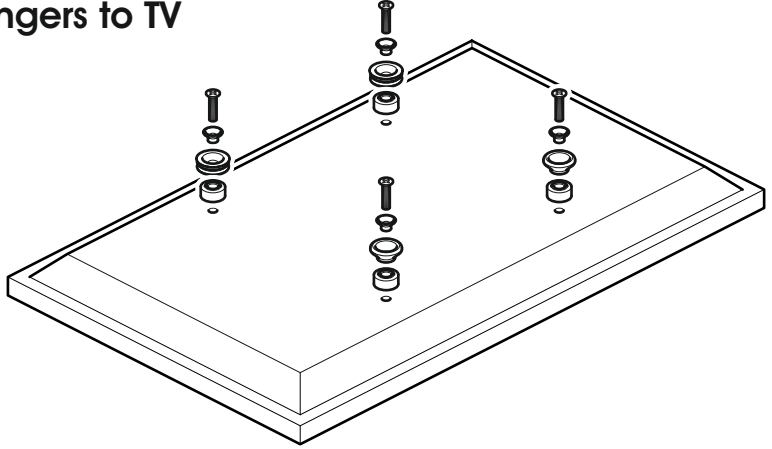

Fitting the Wall Bracket

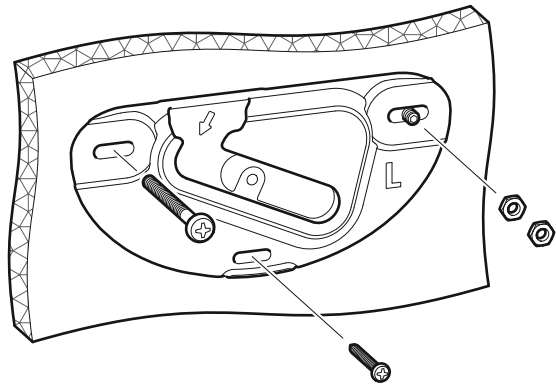

Hanging the TV

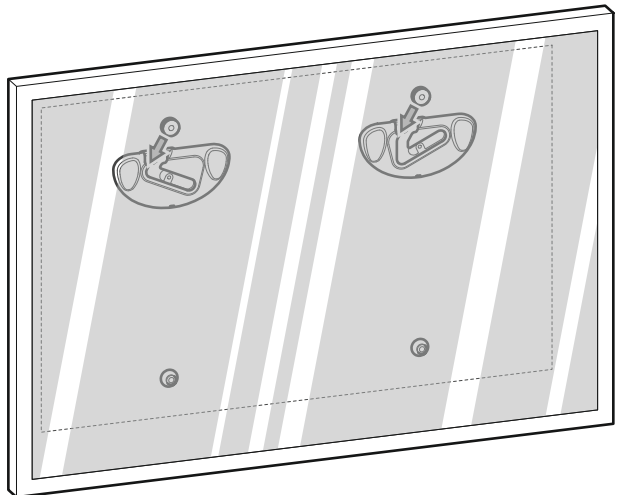

Index

1 Measure the TV fixing holes Width and Height

2 Fit Screen Hangers to TV

3 Assemble Positioning Template

4 Determine Bracket Hole Centers

5 Marking Wall For Drill Points

6 Fitting the Wall Bracket

7 Fitting the Wall Bracket Covers

8 Hanging the TV

Retain all packaging in case the bracket needs to be returned.

Contents may vary from photography / Illustrations.

You will not need all these parts, so expect there to be some left over depending upon the specification of your TV.

This product is intended for indoor use only. Use of this product outdoors could lead to failure and personal injury.

It is the responsibility of the installer to ensure that the mounting wall is of a suitable standard and void of any services (eg gas, electricity, water etc).

AVF accept no responsibility for any damage or loss caused by installing this product in a sub standard wall.

Tools Recommended

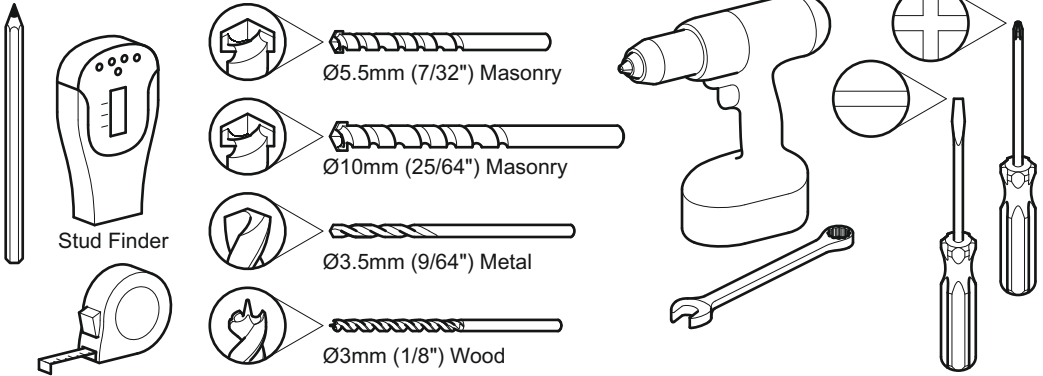

Boxed Parts

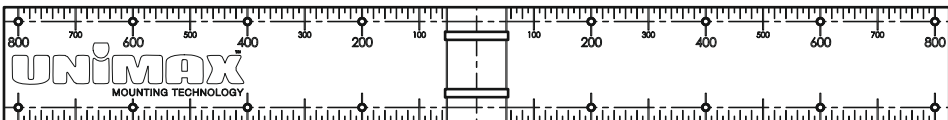
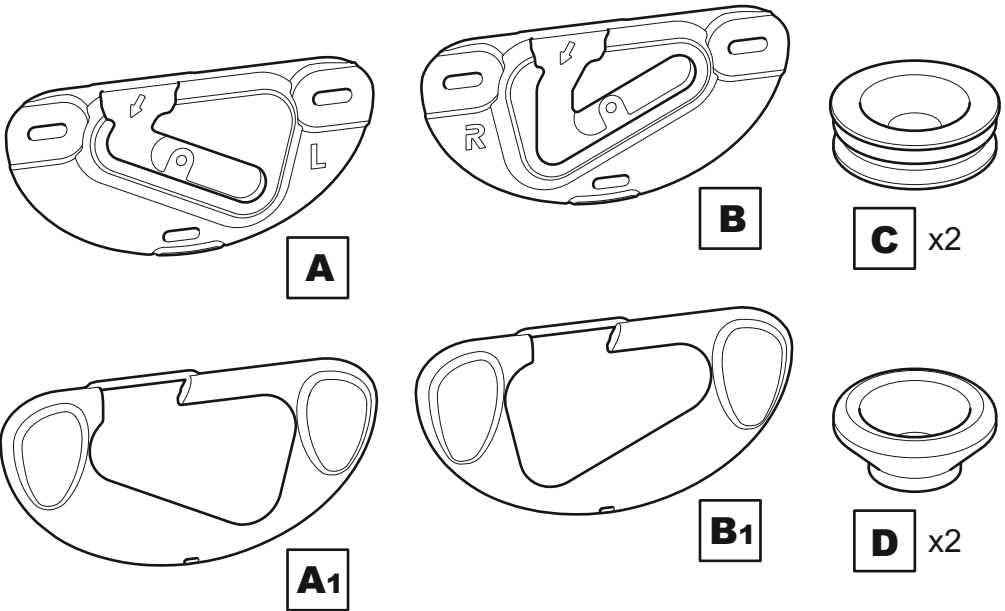

U1

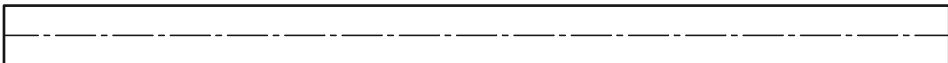

U2

TV Screws, Reducers and Spacers

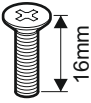

M4

G1 x4

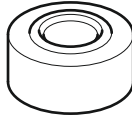

E1 x12

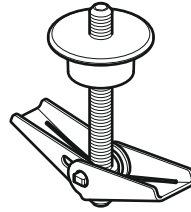

H x4



J x8

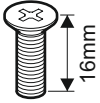

M5

G4 x4

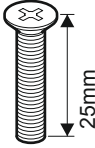

M5

G5 x4

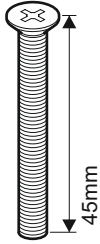

M5

G6 x4



E2 x4



L x2

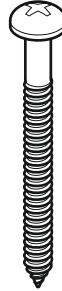

M x4



N x4

O x2

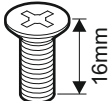

M6

G7 x4

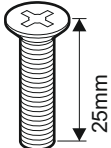

M6

G8 x4

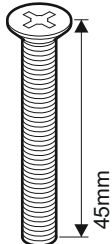

M6

G9 x4



F1 x4



P x2



F2 x4

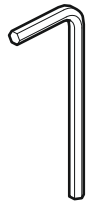

S

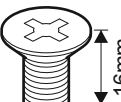

M8

G10 x4

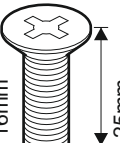

M8

G11 x4

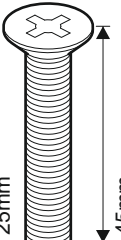

M8

G12 x4



F3 x4



Q x2



R

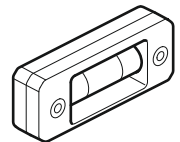

T

Remove the Wall Bracket Covers and keep for step 7

Wall bracket covers **A1** & **B1** are removed in the same way.

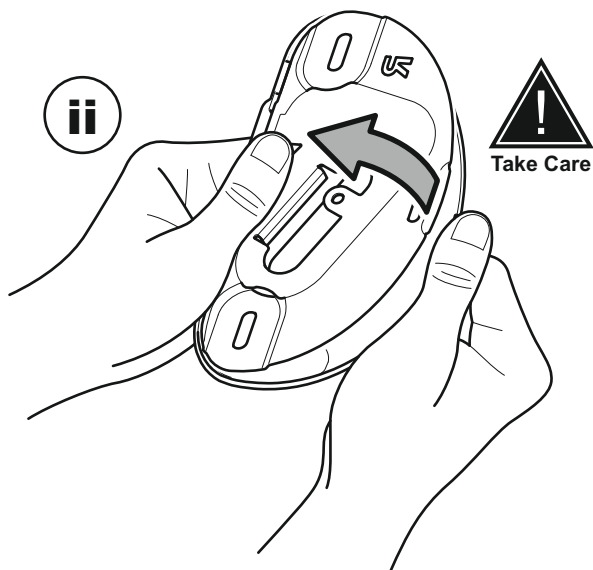
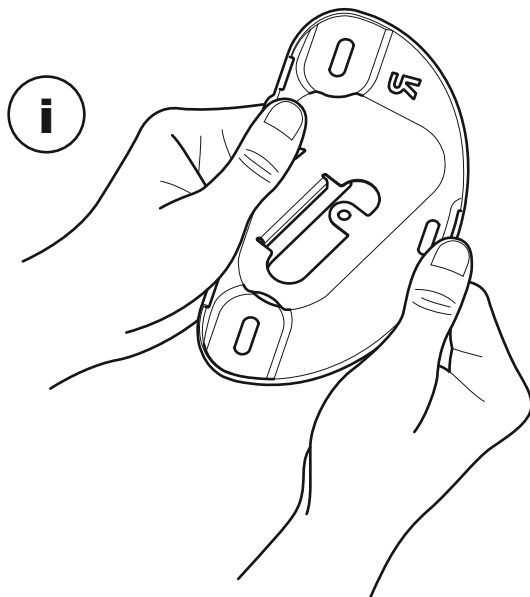

1

Measure the TV fixing holes Width and Height

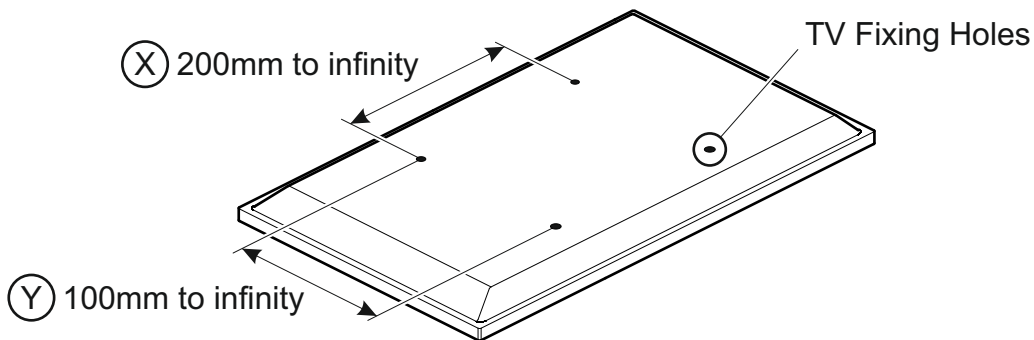

If width **(X)** is less than 200mm or height **(Y)** is less than 100mm
STOP installation now and contact the customer help line

You are provided with 4 diameters of TV fixing screws, **M4**, **M5**, **M6** and **M8**. Determine the screw diameter that fits and remember for step 2.

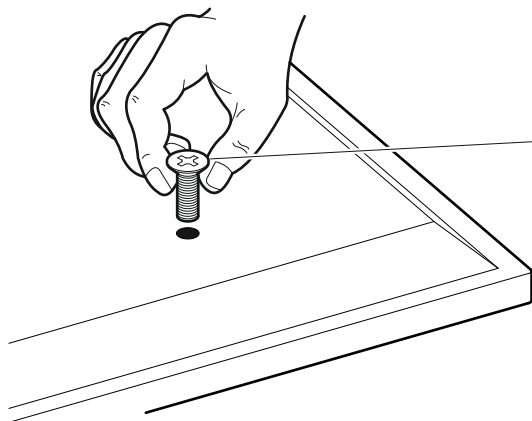

M4 = G1

M5 = G4-G6

M6 = G7-G9

M8 = G10-G12



After completing step 2 you will have TV fixing screws left over,
please keep for future reference

2

Fit Screen Hangers to TV

Once you have established which screw diameter you need for your TV you will need to choose which wall spacing you require. Check the back of your TV and use the **OPTION** that fits your TV. Please see page opposite for more details.

OPTION 1
12mm Wall Space

12mm

TV

Suitable for TVs with a flat back and no obstructions

OPTION 2
20mm Wall Space

20mm

TV

Suitable for TVs with small to medium obstructions eg power supply, mouldings etc

OPTION 3
40mm Wall Space

40mm

TV

Suitable for TVs with large obstructions eg power supply, mouldings etc

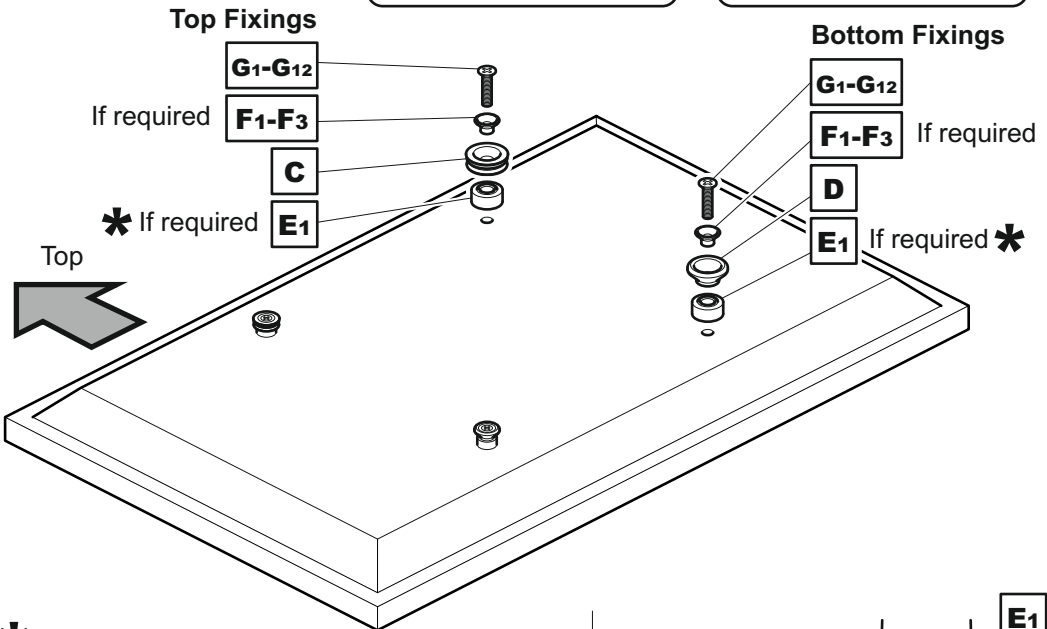

In certain circumstances it may be necessary to use red spacer **E2** as either a replacement or addition to spacer **E1**.

When is it necessary to use red spacers **E2**?

It is recommended that when fitting Hangers **C** and Stand-offs **D** to your TV you have at least 5-10mm of screw engagement. In certain circumstances you may need to use red spacers **E2** as either a replacement, or together with spacers **E1** to achieve this. Whenever you use red spacers **E2** you must use all 4 provided.

Problem
Not enough screw engagement

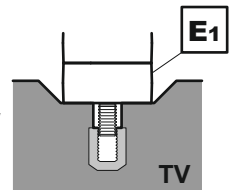



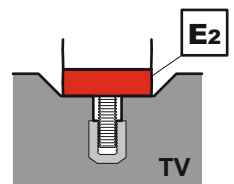



















Solution
Red spacer **E2** has replaced spacer **E1**



OPTION 1
12mm Wall Space

Top Fixings

Bottom Fixings























M4	M5	M6	M8	M4	M5	M6	M8
 G1	 G4	 G7	 G10	 G1	 G4	 G7	 G10
 F1	 F2	 F3		 F1	 F2	 F3	
 C	 C	 C	 C	 D	 D	 D	 D

OPTION 2

20mm Wall Space. Not applicable for M4 fixings **G1**

Top Fixings

Bottom Fixings











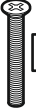
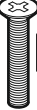





















M5	M6	M8	M5	M6	M8
 G5	 G8	 G11	 G5	 G8	 G11
 F2	 F3		 F2	 F3	
 C	 C	 C	 D	 D	 D
 E1	 E1	 E1	 E1	 E1	 E1

OPTION 3

40mm Wall Space. Not applicable for M4 fixings **G1**

Top Fixings

Bottom Fixings

M5	M6	M8	M5	M6	M8
 G6	 G9	 G12	 G6	 G9	 G12
 F2	 F3		 F2	 F3	
 C	 C	 C	 D	 D	 D
 E1	 E1	 E1	 E1	 E1	 E1
 E1	 E1	 E1	 E1	 E1	 E1
 E1	 E1	 E1	 E1	 E1	 E1

3

Assemble Positioning Template

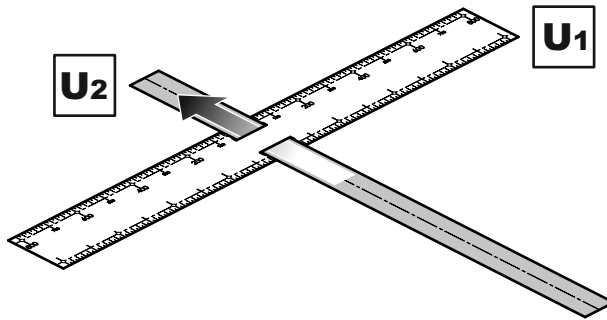

4

Determine Bracket Hole Centers

Lay the template on the back of the TV and follow the instructions below.

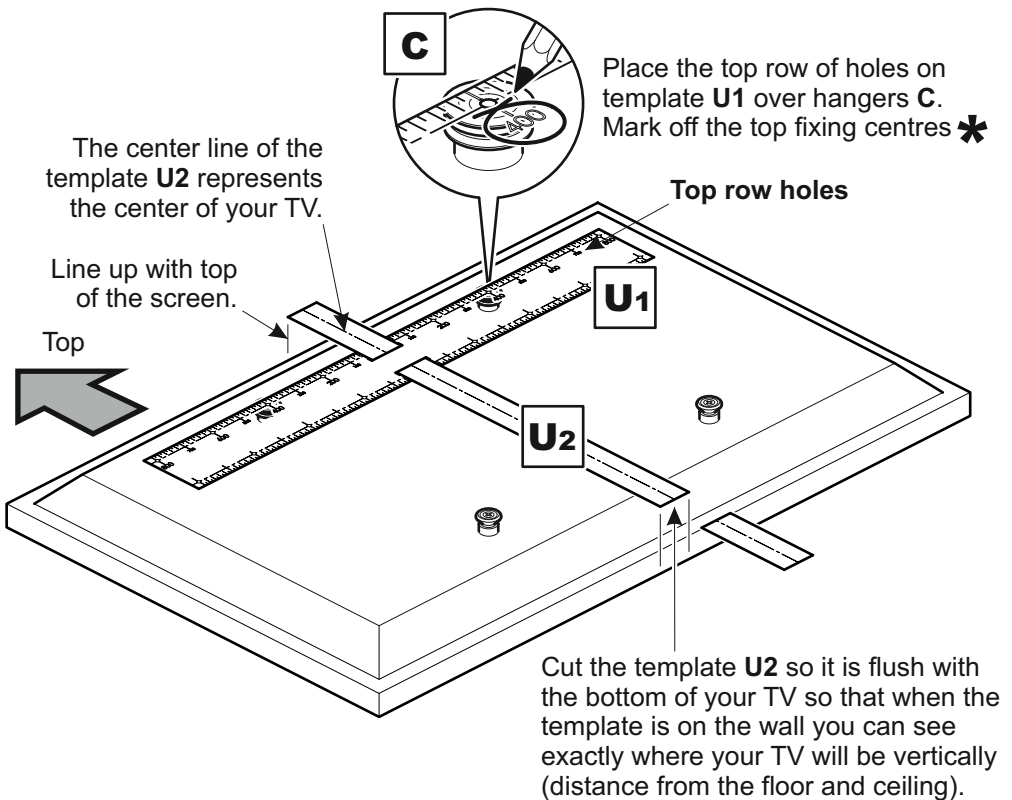

* If hangers **C** do not line up with any holes on the template then ensure template is firmly in position and punch 2 holes to match your top fixing centres with a pencil or sharp object.

5 Marking Wall For Drill Points

Before marking the wall, determine the wall type that you have (i.e. Solid Wall/ Dot & Dab/ Plasterboard/ Wood Stud/Metal Stud). Ensure the drilling area is free from mains services (Gas/Electric/Water).

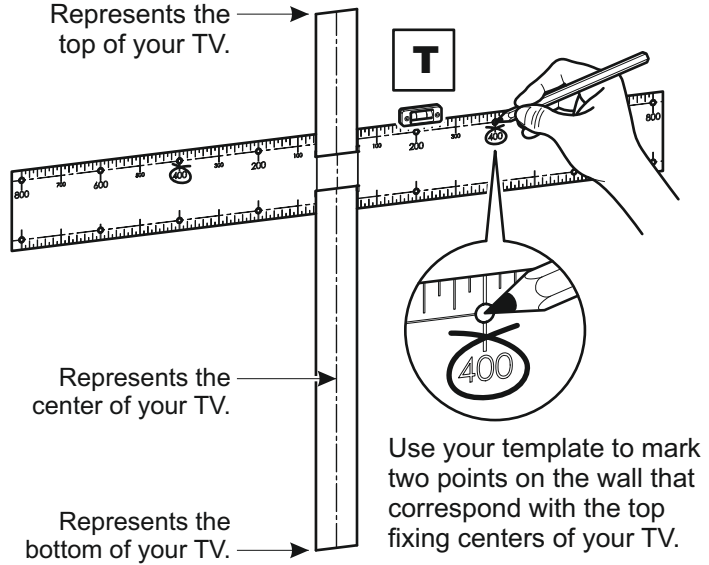

Next, use the Wall Brackets **A** and **B** as a template and position them over the appropriate **PENCIL MARKS** you have made, so that the mark is in the middle of the **CENTRAL HOLE** of the Wall Bracket. Ensure the bracket is level and mark the three **DRILL POINTS** with a pencil. Repeat for other bracket.

Drill six 3mm pilot holes and select appropriate fixings (see section 6)

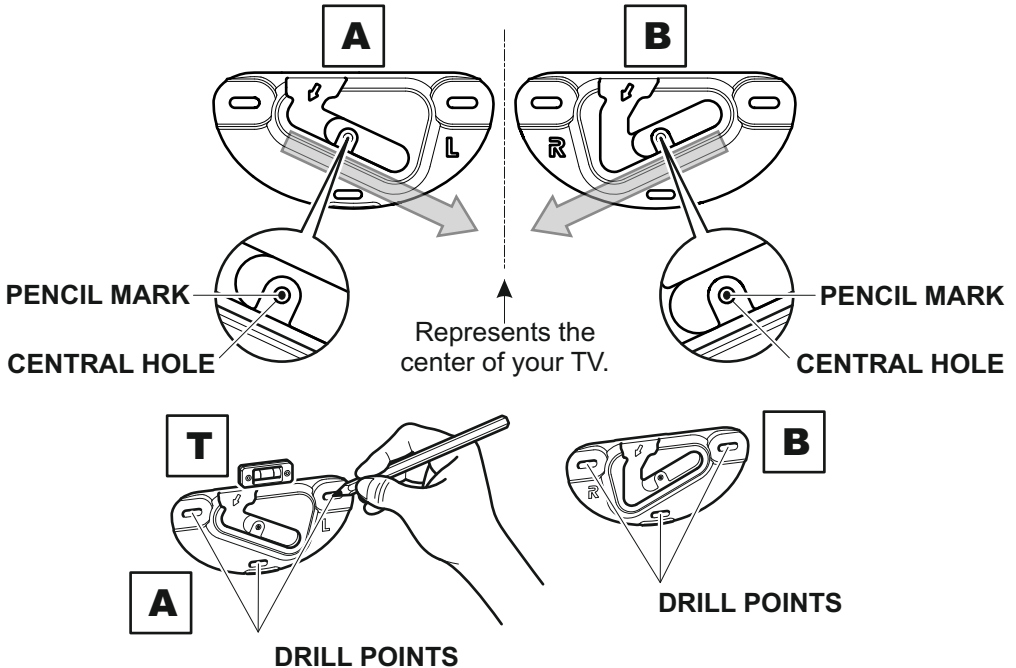

6 Fitting the Wall Bracket

Use the correct fixings for your wall type. Mixing fixing screws may be required for installations that span different wall types. **DO NOT OVER TIGHTEN SCREWS.**

Solid Wall

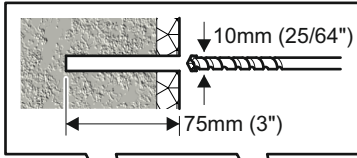

Solid Concrete



Remove dust from holes

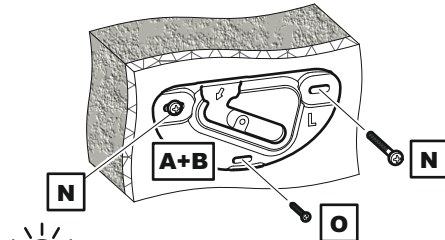
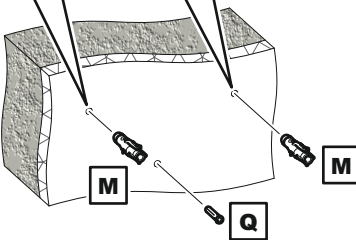
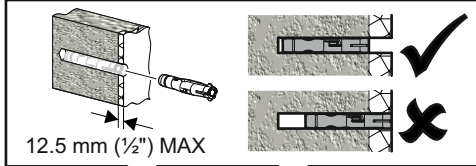
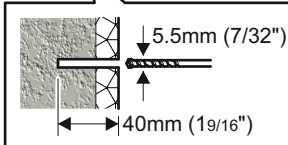

Lubricate screw thread with soap

Drywall

Min supporting surface specification:- 1/2" thick drywall, mounted on 1 1/2" x 3 1/2" wood stud at 16" centers.

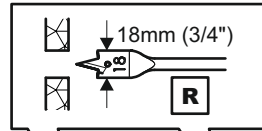

* 40mm (1 9/16") MIN gap



Remove dust from holes

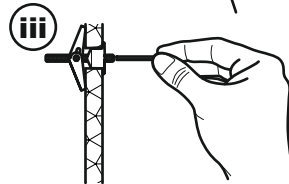
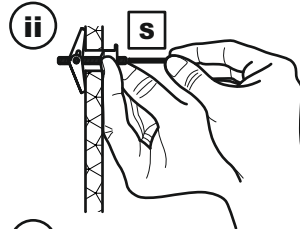
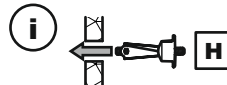

Turn until secure do not over tighten

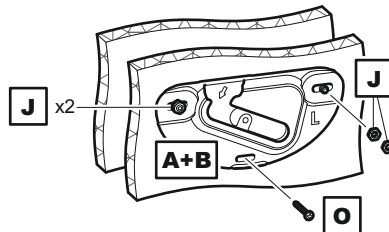

Wood Stud

Min supporting surface specification:-
1/2" thick drywall

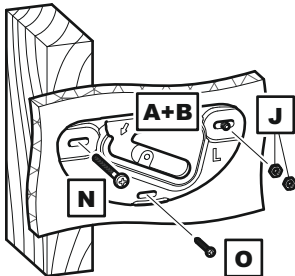
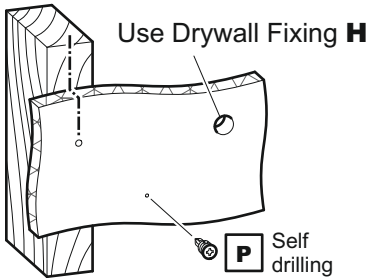
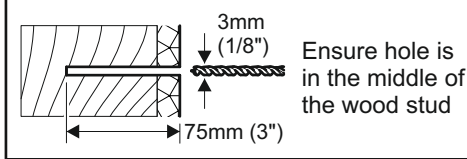
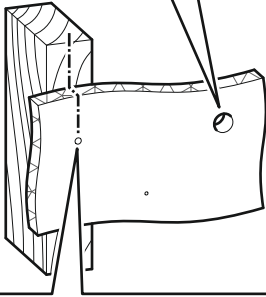
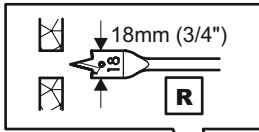

Lubricate screw thread with soap

Only one fixing will be in the wood stud. The other fixings will be in drywall (see above)

Metal Stud

Min supporting surface specification:-
1/2" thick drywall

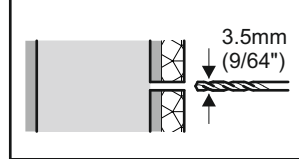
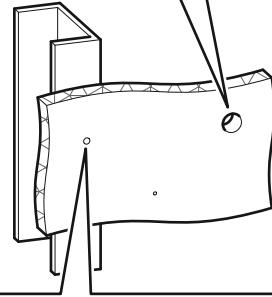
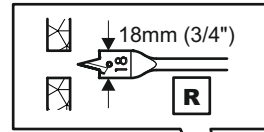

0.6mm (0.025") MIN stud thickness

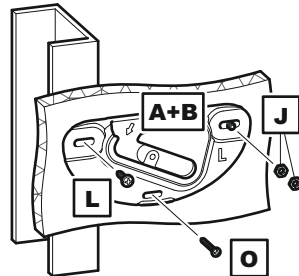
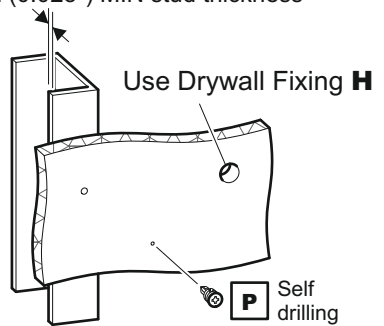

Only one fixing will be in the metal stud. The other fixings will be in drywall (see above)

7

Fitting the Wall Bracket Covers

On wall bracket covers **A1** & **B1** are 3 retaining tabs. These locate onto 3 retaining lips on wall brackets **A** & **B** and lock the wall bracket covers in position.

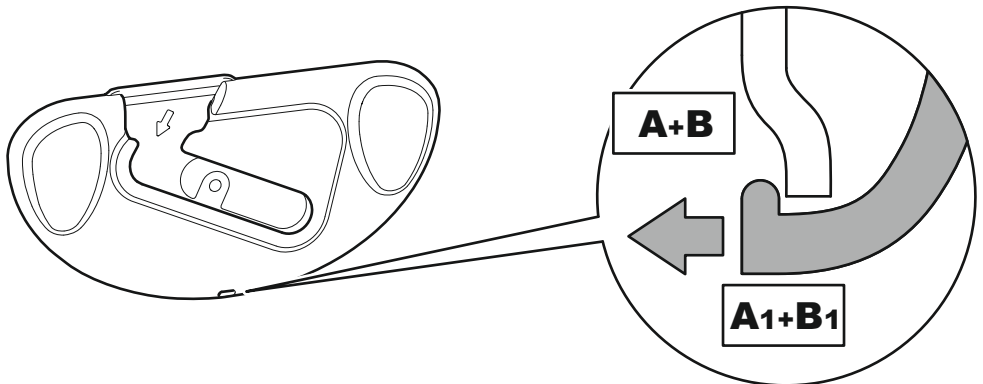
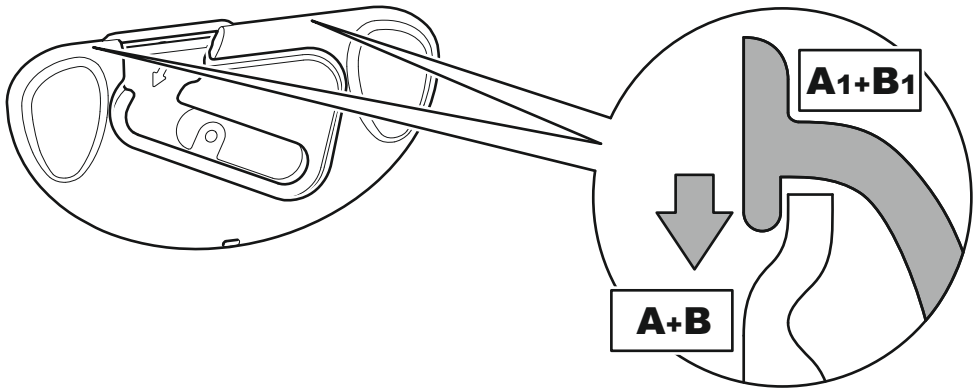
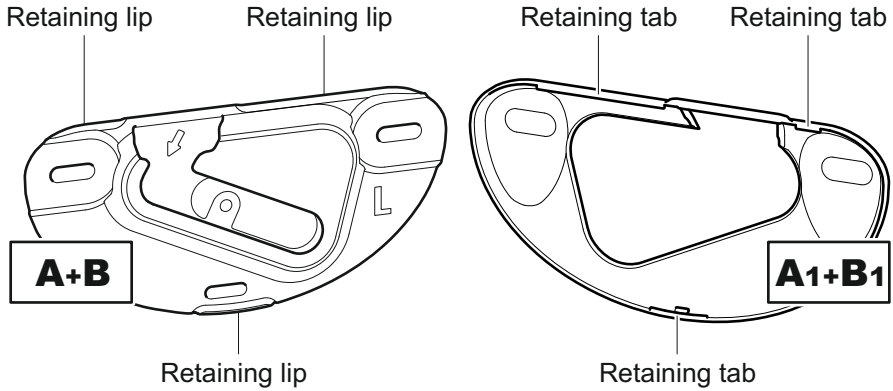

8

Hanging the TV

Hanging the TV is a two person job.

Present hangers **C** (on the back of the TV) to the opening on brackets **A** & **B**. Slide down and across into place. Ensure both hangers are fully engaged. If cables from the TV prevent the TV resting against the wall then an alternative hanger configuration will be required (see section 2).

TV must be parallel to wall. Use spacers / stand-offs as shown in section 2.

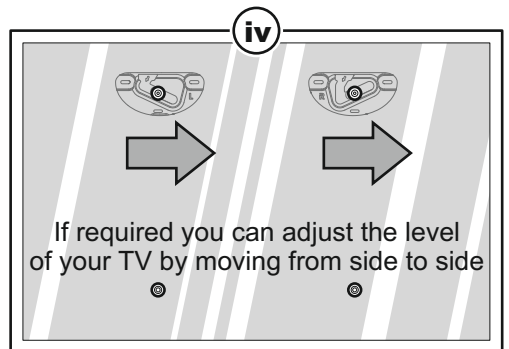
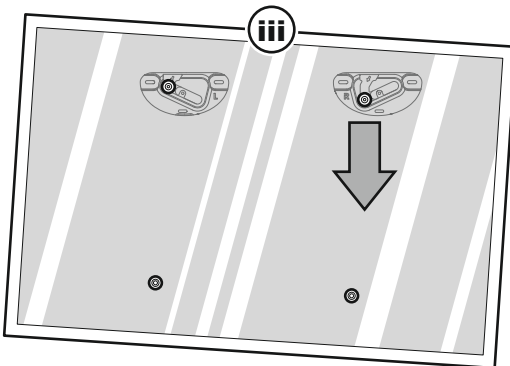
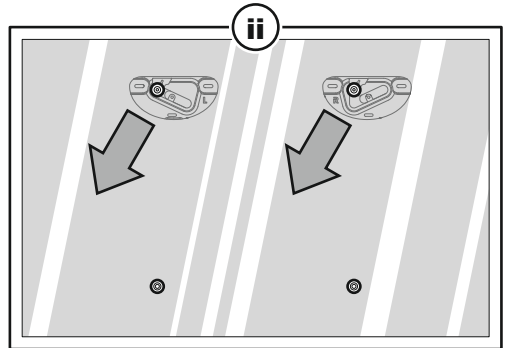
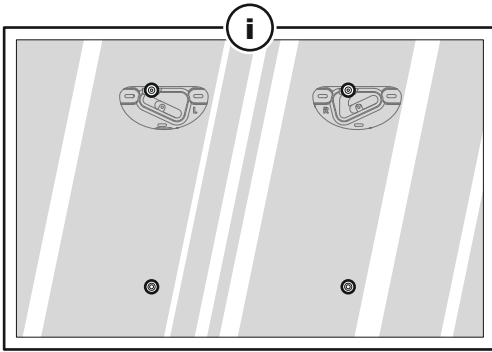
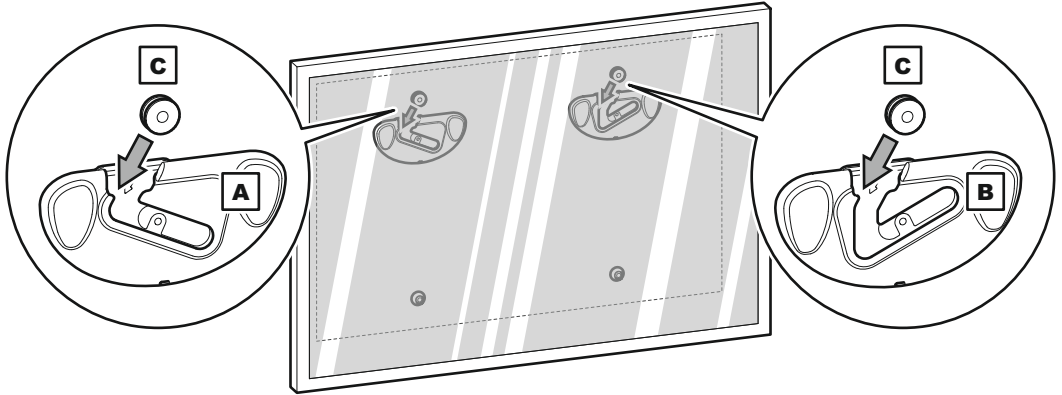

Removing the TV

This is a two person job. To remove the TV reverse the movements as shown above.

Removing the Wall Bracket Covers

Should you want to remove the wall bracket covers please follow the steps below.

