

JML8400

Leaflet No. 463448 rev00

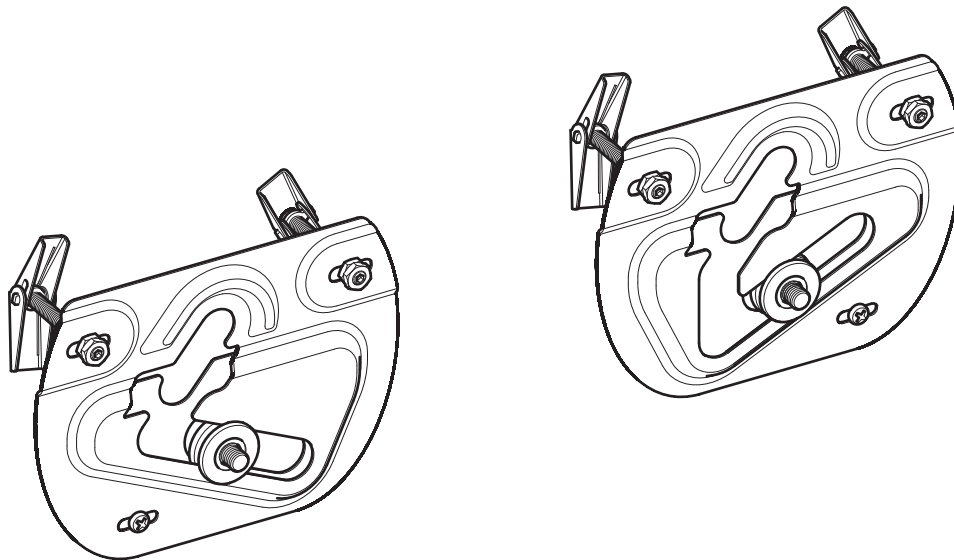

*Read through **ALL** instructions before commencing installation.
If you have any questions about this product or issues with installation
contact the customer services helpline before returning this product to
the store. See jl.avfgroup.com/p/jml8400 for more information.*

CUSTOMER SERVICES HELP LINE NUMBER:

01952 670009

0870 0609777



AVF Group Ltd. Road 30. Hortonwood Ind Est, Telford, Shropshire, TF1 7YE, England

1 Boxed Parts

You will not need all these parts, so expect there to be some left over depending upon the specification of your TV.

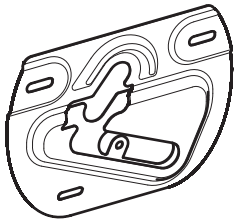

A - x1
LH Wall Bracket

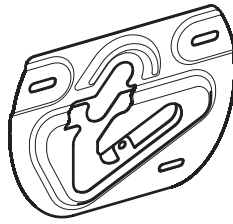

B - x1
RH Wall Bracket



C - x2
Hanger (Yellow)



D - x2
Stand-off

TV Fixings: Parts go on the back of the TV (specification of your TV will determine which ones you require - see section 11).

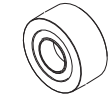

E1 - x12



E2 - x4

Spacer Spacer (Red)



F1 - x4
M4 Adaptor



F2 - x4
M5 Adaptor



F3 - x4
M6 Adaptor



G1 - x4
M4 16mm



G2 - x4
M4 25mm



G3 - x4
M4 45mm



G4 - x4
M5 16mm



G5 - x4
M5 25mm

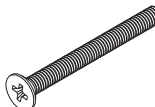

G6 - x4
M5 45mm



G7 - x4
M6 16mm



G8 - x4
M6 25mm

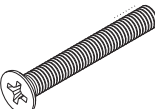

G9 - x4
M6 45mm



G10 - x4
M8 16mm

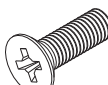

G11 - x4
M8 25mm

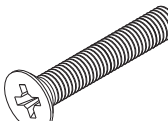

G12 - x4
M8 45mm

Wall Fixings: Parts to attach to the wall (type of wall will determine which fixings you require).

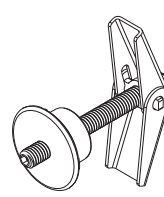

H - x4
Wall Fixing

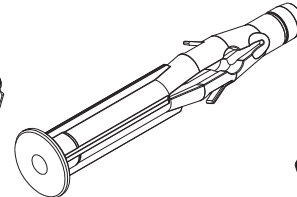

I - x4
Long Wall Plug



J - x8
Lock Nut

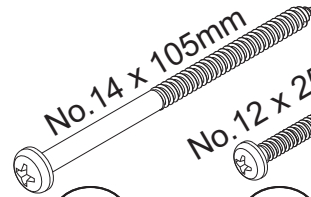

K - x4
Long Screw



L - x2
Metal Stud Screw

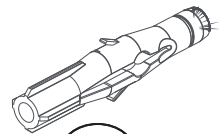

M - x4
Wall Plug Screw

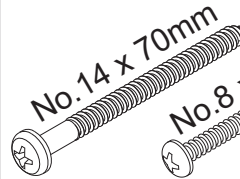

N - x4
Screw

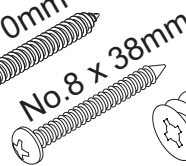

O - x2
Screw

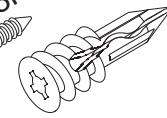

P - x2
Screw Plug

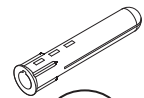

Q - x2
Wall Plug

Included Tools



R - x1
18mm Wood Drill



S - x1
3mm Hex Key

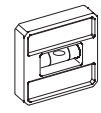

T - x1
Level

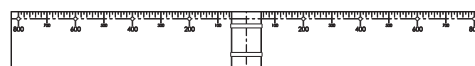

U1 - x1

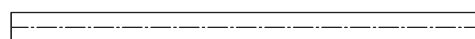

U2 - x1

Template

2 Tools Required

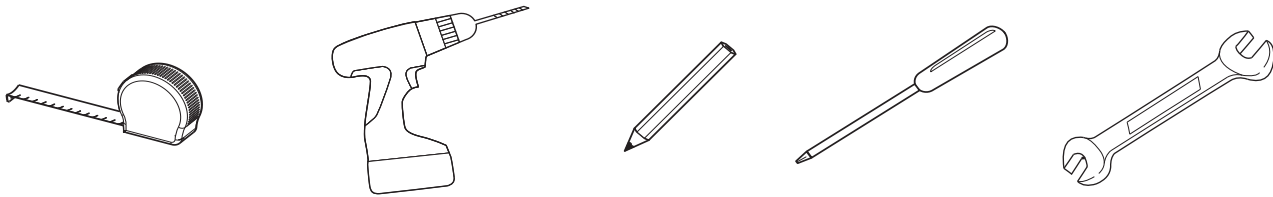

3 Determine Correct TV Screw Size

Choose from the TV Fixings selection. You need to determine which length and diameter of screws fits your TV. To determine the correct screw diameter, try screwing (**G2**), (**G5**), (**G8**) & (**G11**) into one of the fixing holes on the back of the screen until you find the one that fits.

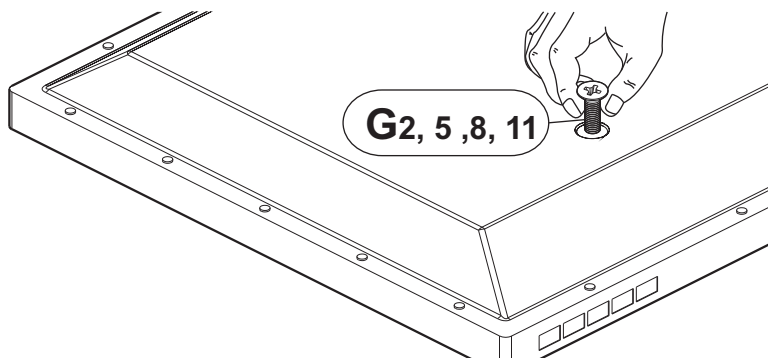

4 Fit Screen Hangers To TV

Once you have established which screws you need for your TV, you can attach the Hangers (**C**) and Stand-offs (**D**) to the back of your TV.

Typical recommended example shown is for fixings with the TV spaced 20mm from the wall. The TV Mount can position your TV between 12mm and 40mm from the wall. For alternative configurations see section 11.

You might need to use spacers to increase the clearance of your TV from the wall in order to avoid cables coming out of your TV and improve access and ventilation to the back of your TV (spacers (**E1**) allow you to have a gap of 20mm or 40mm, see section 11).

In certain circumstances it may be necessary to use red spacer (**E2**) as either a replacement or addition to spacer (**E1**), for more information please see section 11.

If your TV fixing centres don't fit, STOP installation and contact the customer services helpline.

Top Fixings

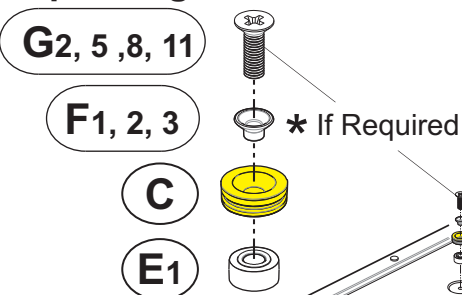

Bottom Fixings

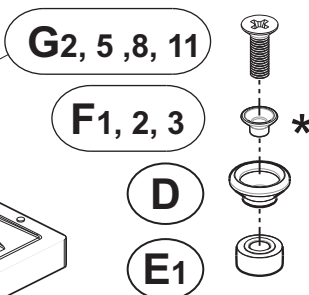

TV must be parallel to wall. Use spacers / stand-offs as shown.

* If using screw (**G2**) use Adapter (**F1**)
If using screw (**G5**) use Adapter (**F2**)
If using screw (**G8**) use Adapter (**F3**)
If using screw (**G11**) No Adapter required

5 Assemble Positioning Template

The horizontal part of the positioning template is used to mark out where you need to drill the mounting holes on your wall. The vertical part is just a guide to allow you to see how high up the wall your TV will be to help you find the perfect position for viewing your screen. Thread template (T2) through template (T1) as shown.

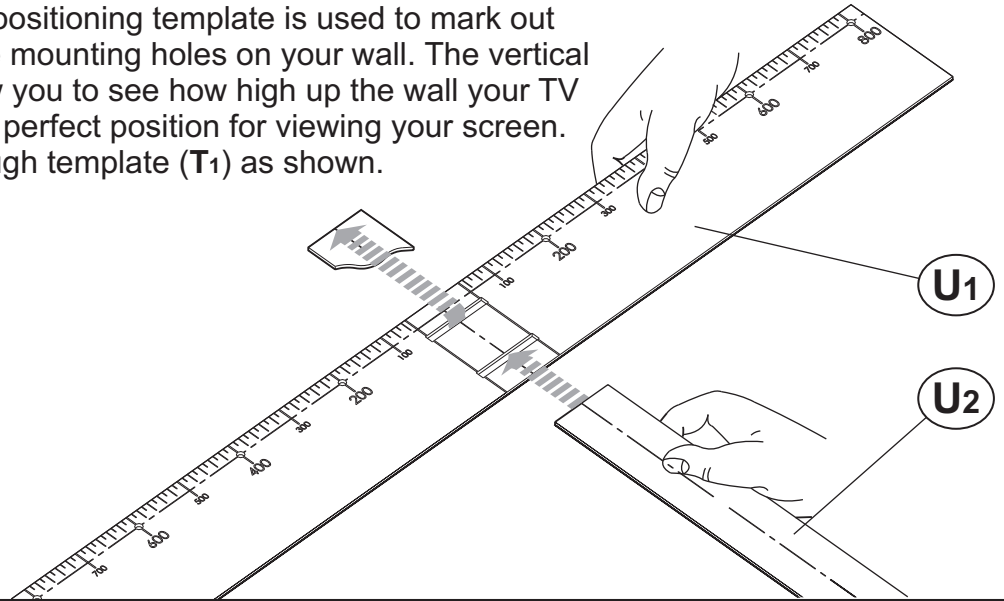

6 Determine Bracket Hole Centres

Lay the template on the back of the TV and follow the instructions below.

The centre line of the template represents the centre of your TV.

Line up with top of the screen.

Line up the template with the centre of the screen. Mark off the fixing centres.

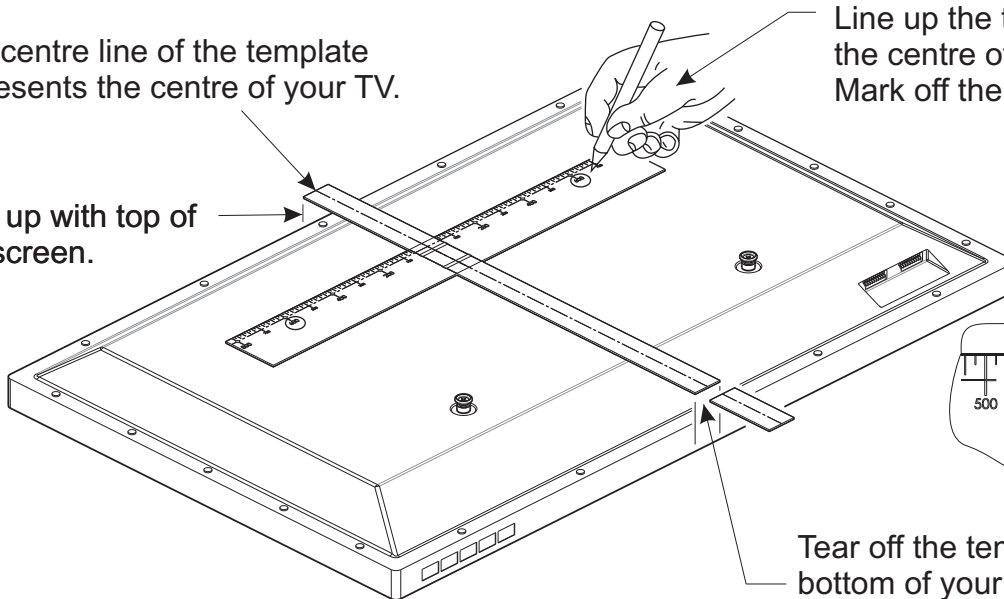

Tear off the template flush with the bottom of your TV so that when the template is on the wall you can see exactly where your TV will be vertically (distance from the floor and ceiling).

If your screen fixings do not line up with any holes on the template then ensure template is on the centre of the screen, and punch holes to suit your screen fixings centres with a pencil or sharp object.

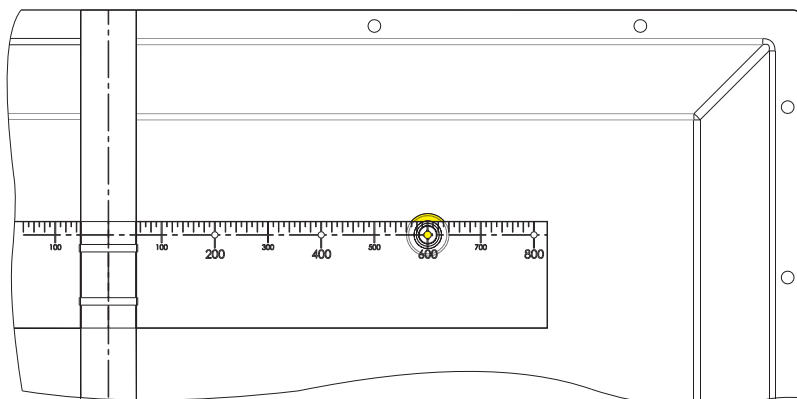

7 Marking Wall For Drill Points

Use your template to mark two points on the wall that correspond with the top fixing centres of your TV.

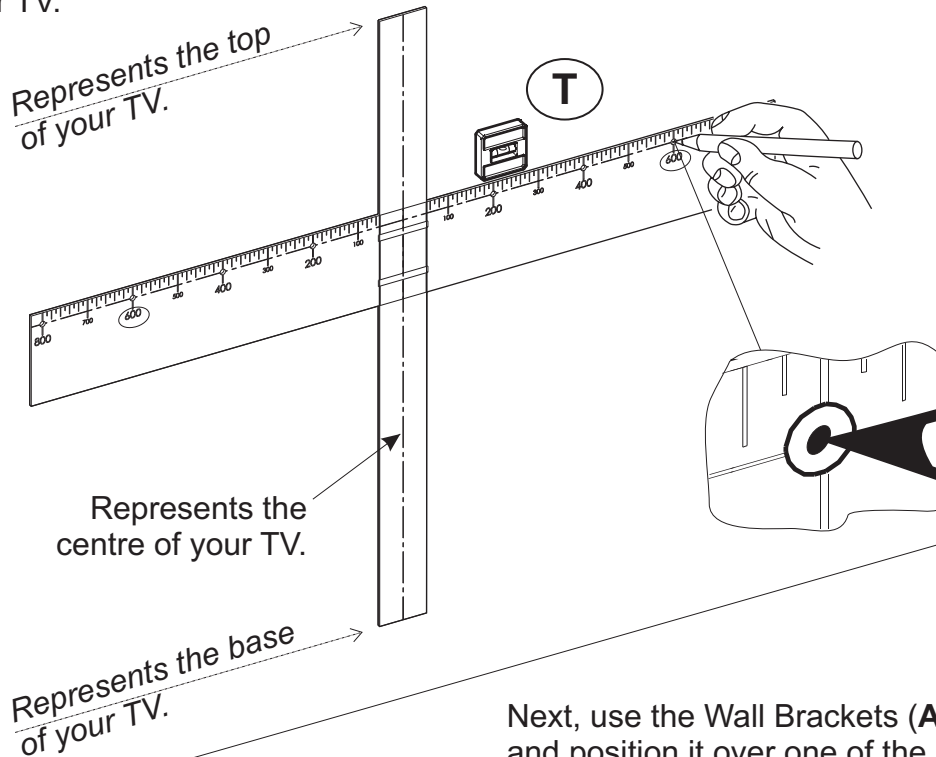

Next, use the Wall Brackets (A) and (B) as a template and position it over one of the PENCIL MARKS you have made, so that the mark is in the middle of the CENTRAL HOLE of the Wall Bracket (A). Ensure the bracket is level and mark the three DRILL POINTS with a pencil. Repeat for both brackets.

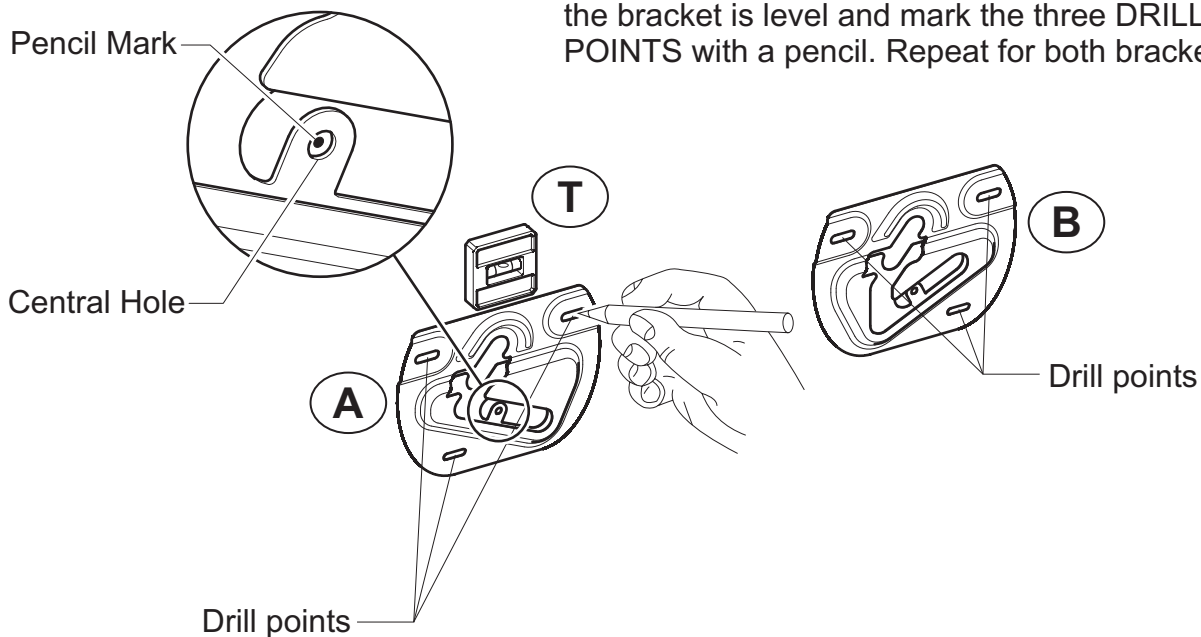

8 Planning & Preparation

Determine the wall type that you have (i.e. Brick/Stud/Plasterboard/Sheetrock).

Ensure the drilling area is free from mains services (Gas/Electric/Water).

Drill six 3mm diameter pilot holes to verify the wall type and select the appropriate fixings (See Section 9).

9 Install Wall Fixings

Use the correct fixings for your wall type. Mixing fixing types may be required for installations that span different wall types. **DO NOT OVER TIGHTEN SCREWS.**

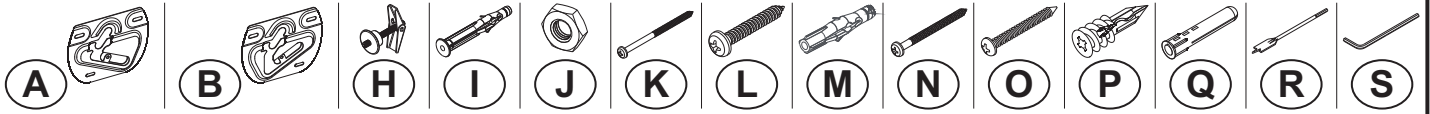

Solid Wall

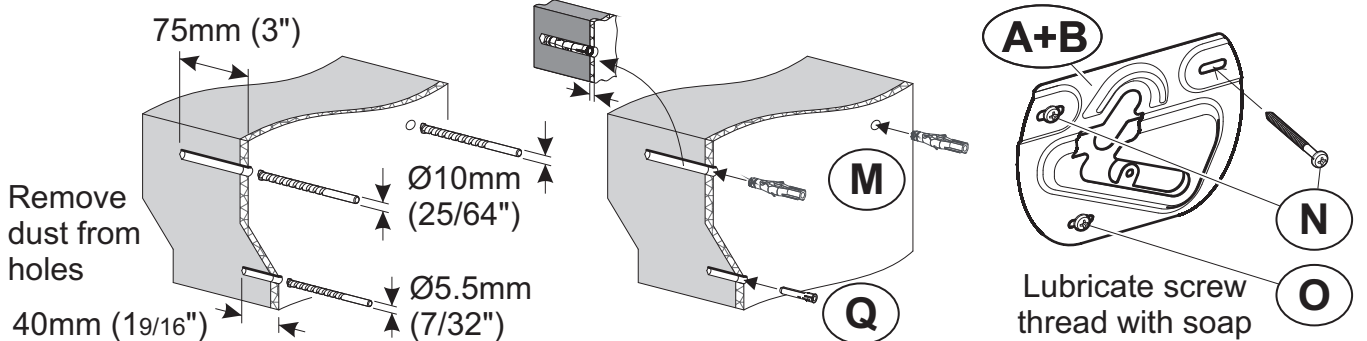

Dot & Dab

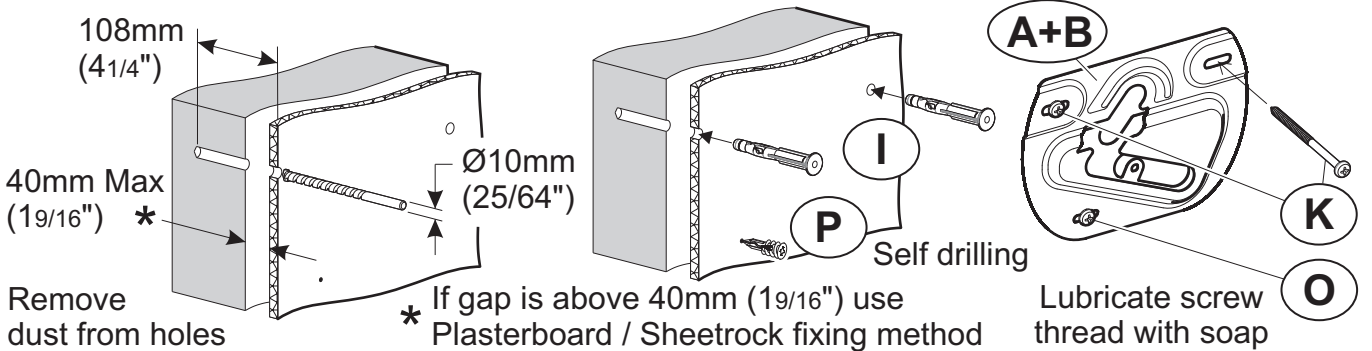

Plasterboard / Sheetrock

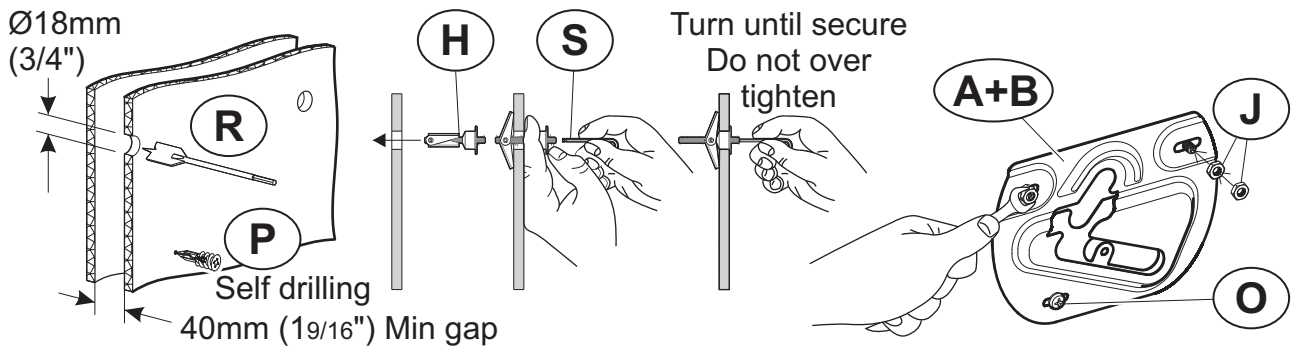

Wood Stud

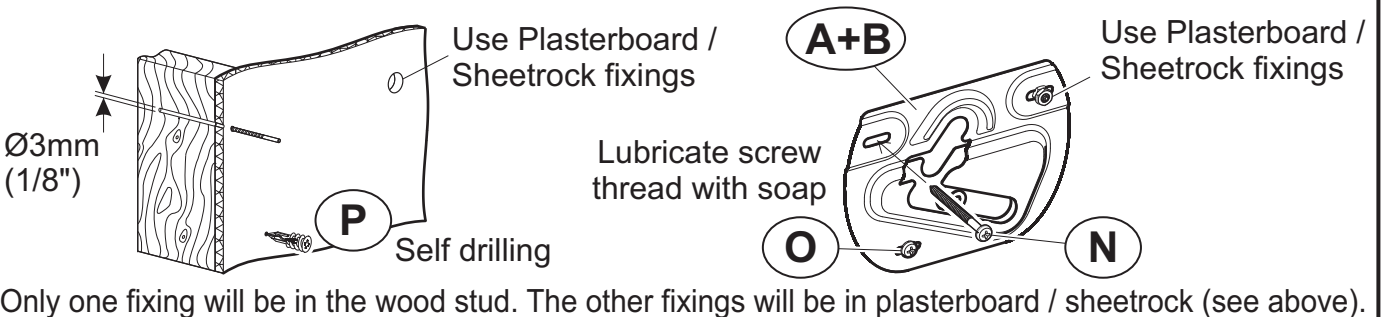

Metal Stud

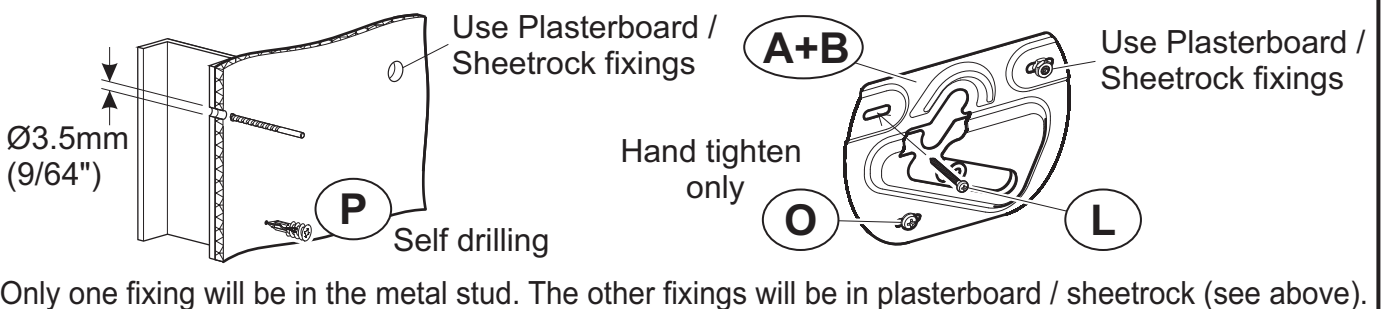

10 Hanging The TV

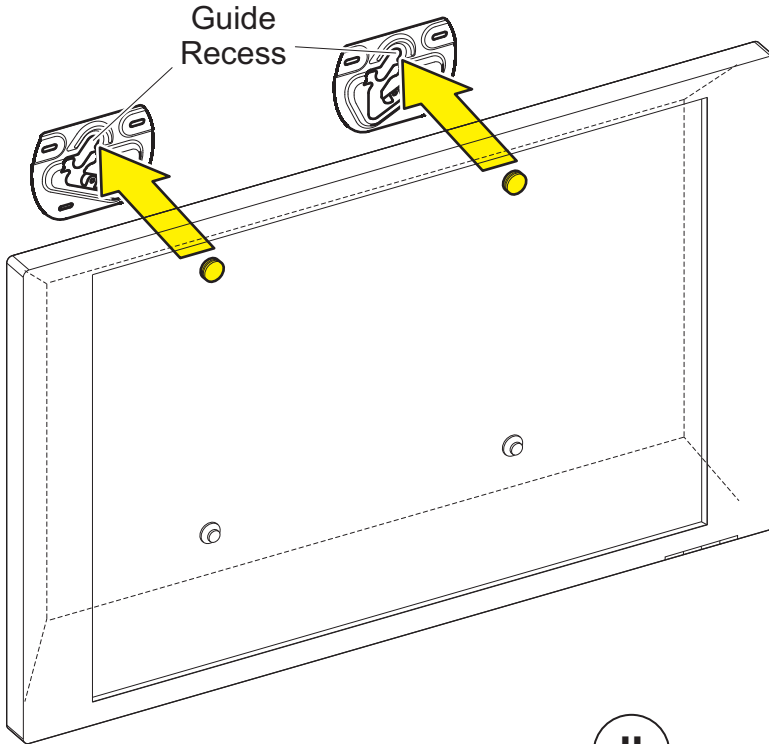

Present the yellow Hangers (on the back of the TV) to the guide recess on the Wall Brackets. Slide down and across into place. Ensure both yellow Hangers are fully engaged. If cables from the TV prevent the TV resting against the wall then an alternative hanger configuration will be required (See Section 11).

TV must be parallel to wall. Use spacers / stand-offs as shown.

I

II

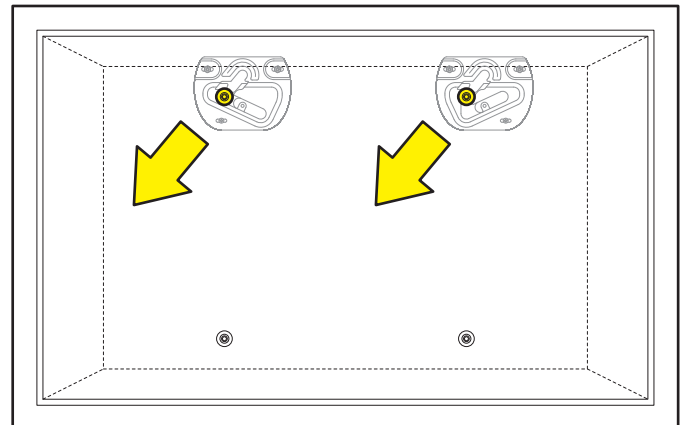
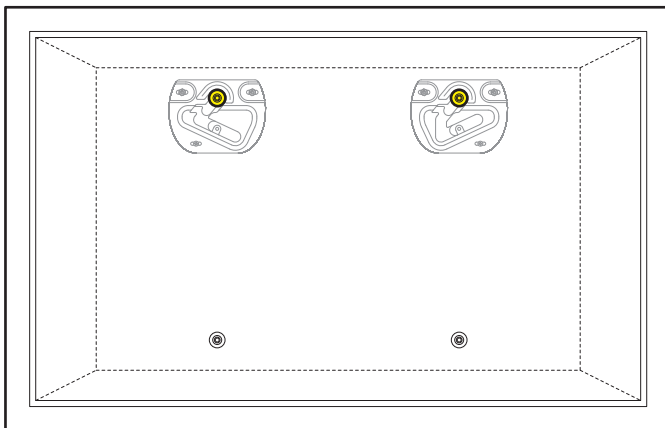

III

IV

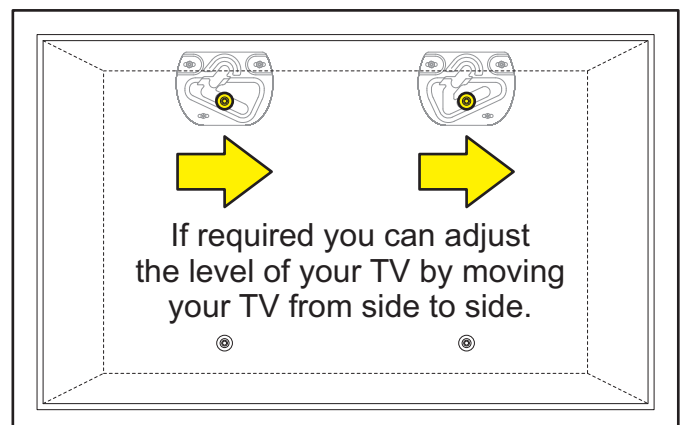
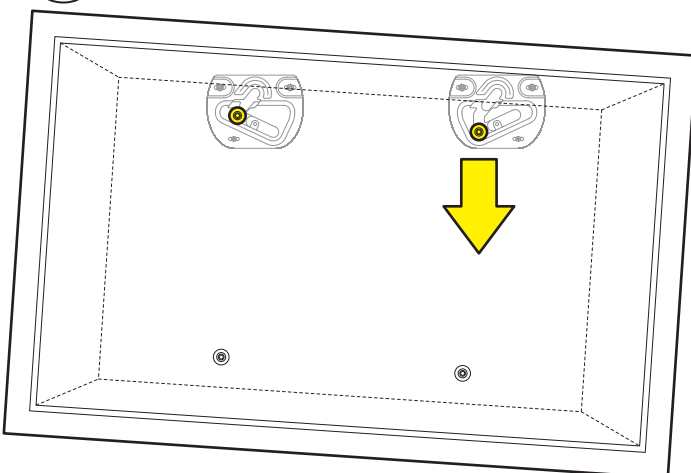

Removing the TV

This is a two person job. To remove the TV reverse the movements as shown above.

Alternative Hanger Configurations

Alternative Wall spacings of 12mm, 20mm & 40mm can be achieved using the spacer / screw combinations listed in this section.

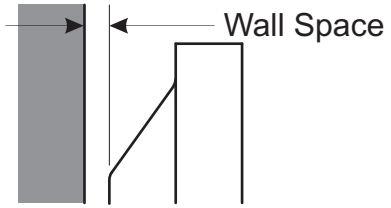

12mm Wall Space

Top Fixings

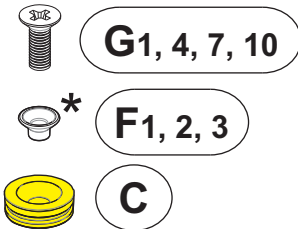

Bottom Fixings

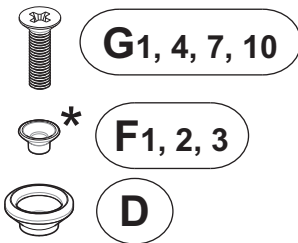

20mm Wall Space (as shown in section 4)

Top Fixings

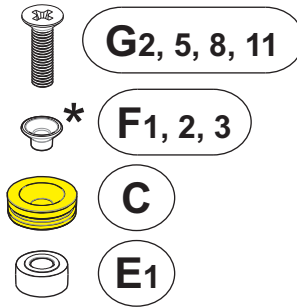

Bottom Fixings

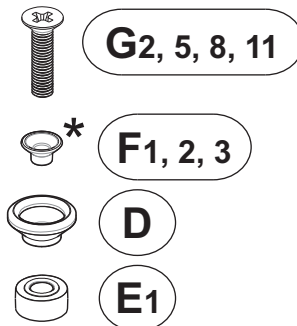

40mm Wall Space

Top Fixings

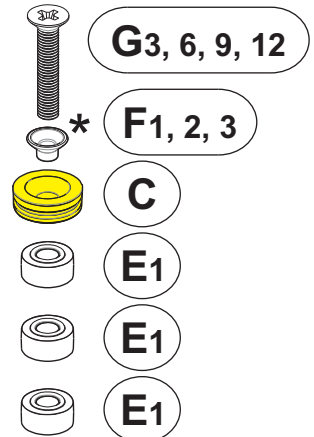

Bottom Fixings

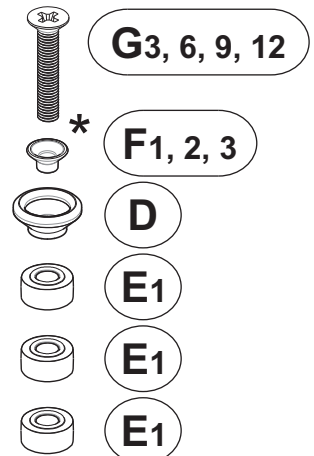

TV must be parallel to wall. Use spacers / stand-offs as shown.

- * If using screw (G₁),(G₂) or (G₃) use Adapter (F₁)
- * If using screw (G₄),(G₅) or (G₆) use Adapter (F₂)
- * If using screw (G₇),(G₈) or (G₉) use Adapter (F₃)
- * If using screw (G₁₀),(G₁₁) or (G₁₂) No Adapter required

When is it necessary to use red spacers?

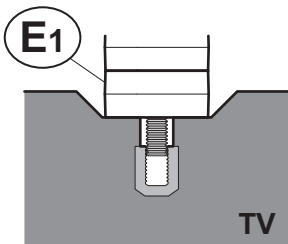

Problem
Not enough screw engagement

It is recommended that when fitting Hangers (C) and Stand-offs (D) to your TV you have at least 5-10mm of screw engagement. In certain circumstances you may need to use red spacers (E2) as either a replacement, or together with spacers (E1) to achieve this. Whenever you use red spacers (E2) you must use all 4 provided.

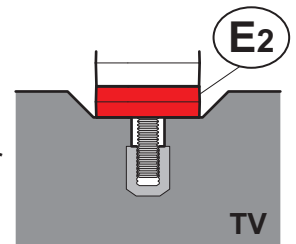

Solution
Red spacer (E2) has replaced spacer (E1)