

## 1 Unpack

## Boxed Parts

- Please read the hints and tips below to help you with the application of your cable management.**
- !** Ensure you roll wall strip **A** and cover strip **B** smoothly and evenly to prevent creasing.
  - !!** Ensure both wall strip **A** and cover strip **B** are as flat as possible before attaching to the wall.
  - !!!** Ensure the surface you wish to attach the cable management to is clean and dry.
  - !v** Ensure that before you attach wall strip **A** you are happy with the position.
  - v** Ensure when you attach wall strip **A** to the wall that you press firmly and that you remove all air bubbles, repeat after 5 minutes.

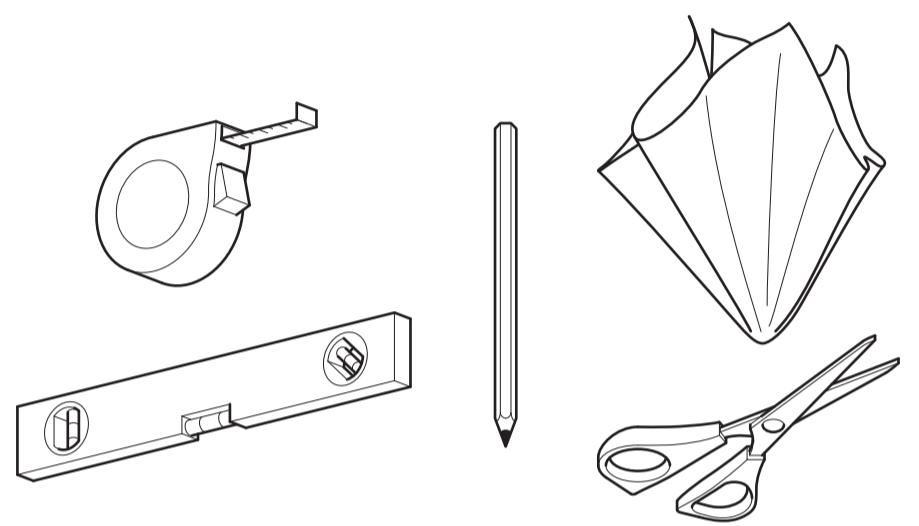

## Tools Recommended

## 5 Attaching Cover Strip B

**!** You can tie a piece of string around your cables at the top and bottom to make it easier to attach cover front strip **B**.

- i** With cables in place, hook one side of cover strip **B** into wall strip **A**.
  - ii** Working from the top, squeeze cover strip **B** so the other side hooks into place.
  - iii** With the top of cover strip **B** in place you will be able to hook the rest of cover strip **B** into place by firmly squeezing and sliding your thumb downwards.
- 

## 6 Finishing Touch

**!** If you desire you can paint your cable management to suit your decor for an even more stylish, low key finish.

# JZA200

Leaflet No. 463438 rev.00

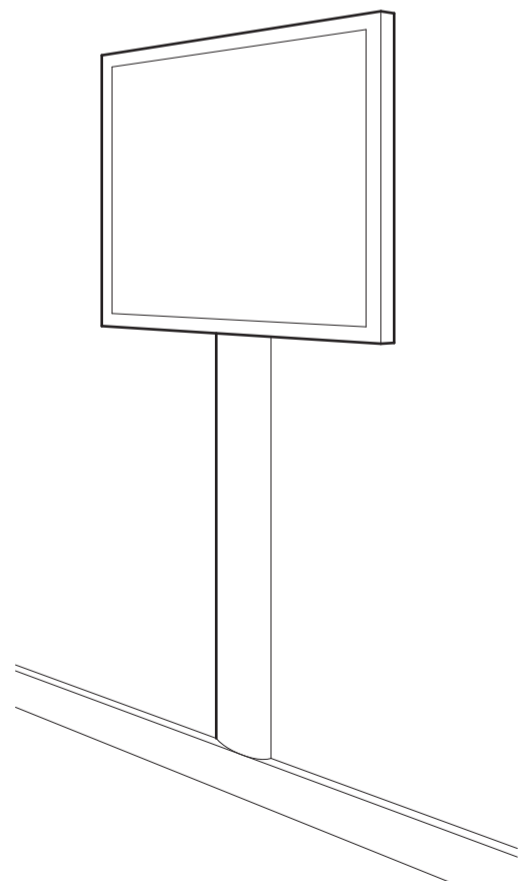

Read through **ALL** instructions before commencing installation. If you have any questions about this product or issues with installation contact the customer services helpline before returning this product to the store. See [j.l.avfgroup.com/p/jza200](http://j.l.avfgroup.com/p/jza200) for more information.

CUSTOMER SERVICES HELP LINE NUMBER:

**01952 670009**

**0870 0609777**

## 2 Uncurling and Flattening

 Be careful not to crease, roll smoothly and evenly.

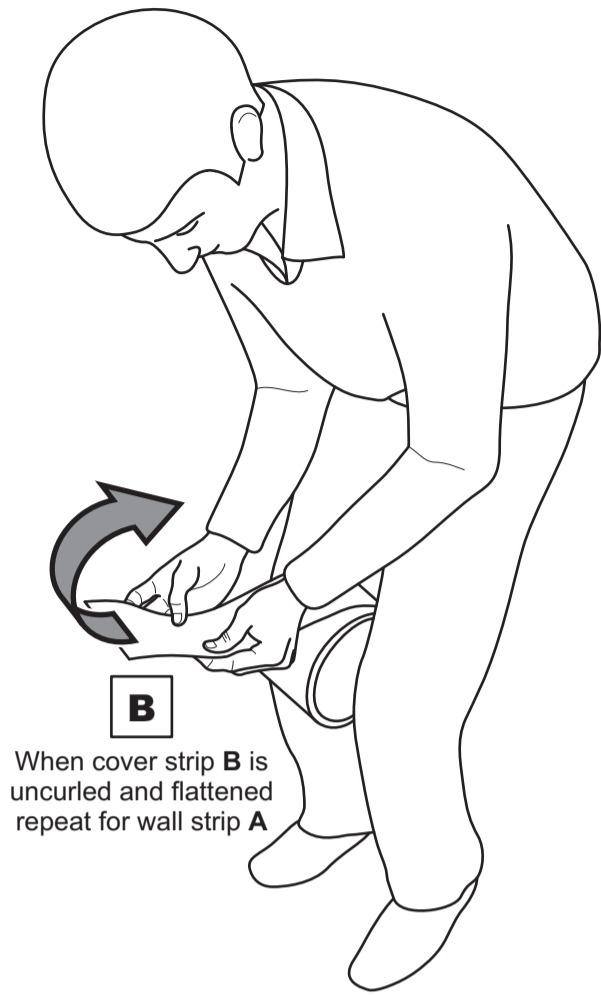

When cover strip **B** is uncurled and flattened repeat for wall strip **A**

 When uncurling and flattening wall strip **A** and cover strip **B**, put the roll between your knees to keep the roll steady while you roll the strip back on itself. We recommend this action is performed a minimum of 3 times to get the required result.

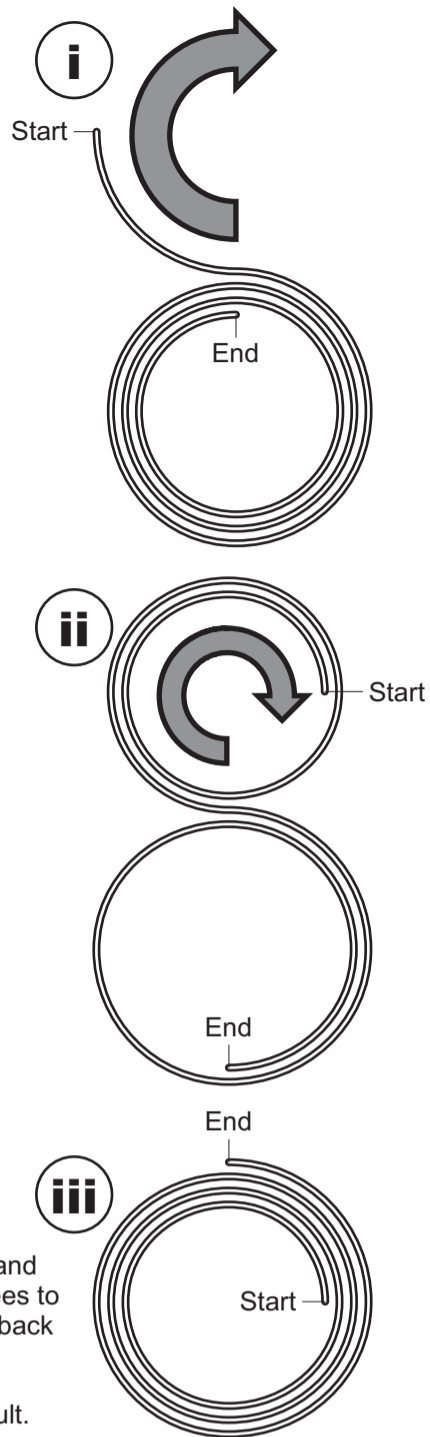

## 3 Measuring and Cutting

Measure and cut wall strip **A** and cover strip **B**

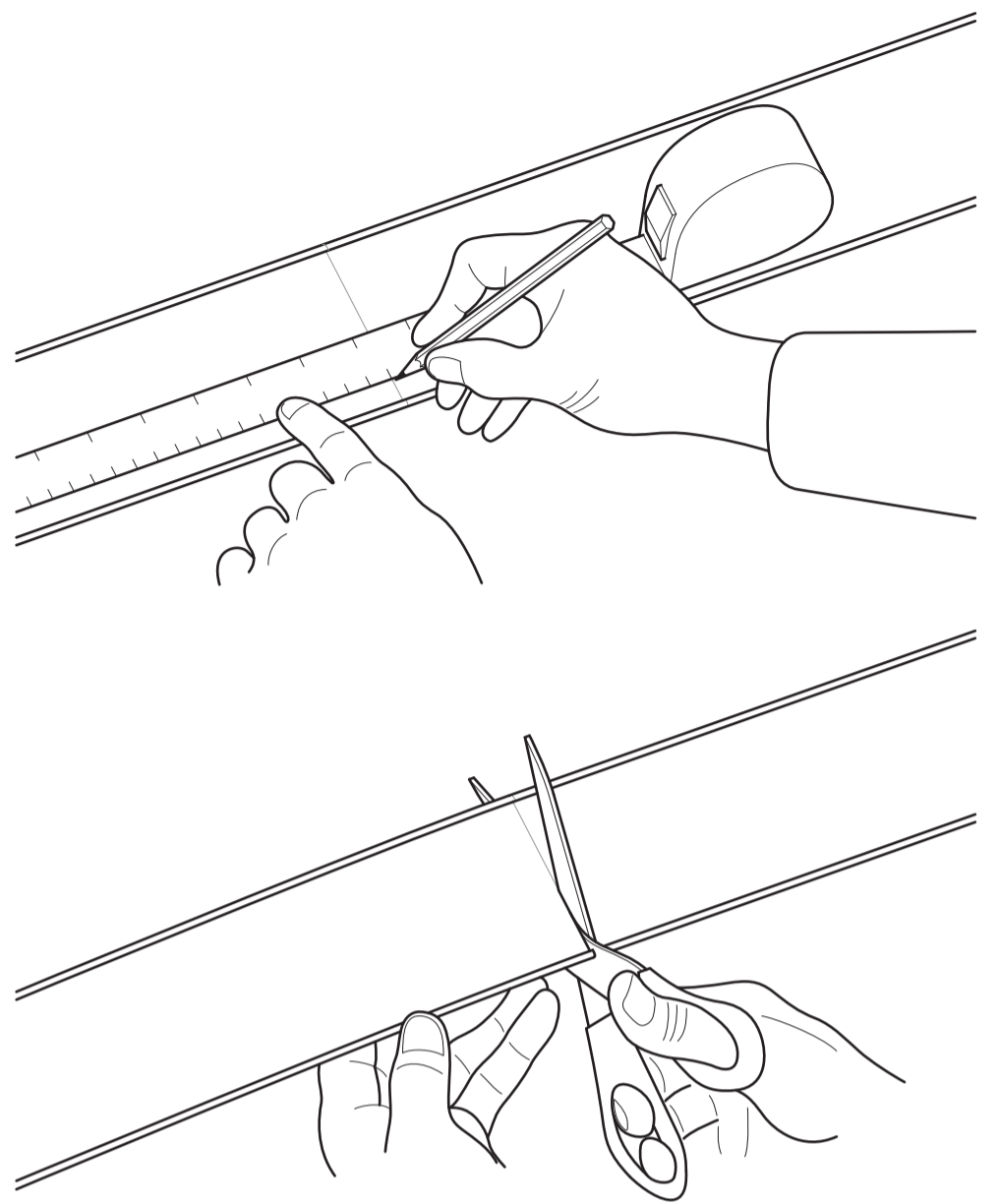

## 4 Attaching Wall Strip A

 Before you attach wall strip **A**, make sure you are happy with the position

**i**

Before you attach wall strip **A**, use a clean, slightly damp cloth to clean the surface, let it dry thoroughly. Failure to do this will result in poor attachment.

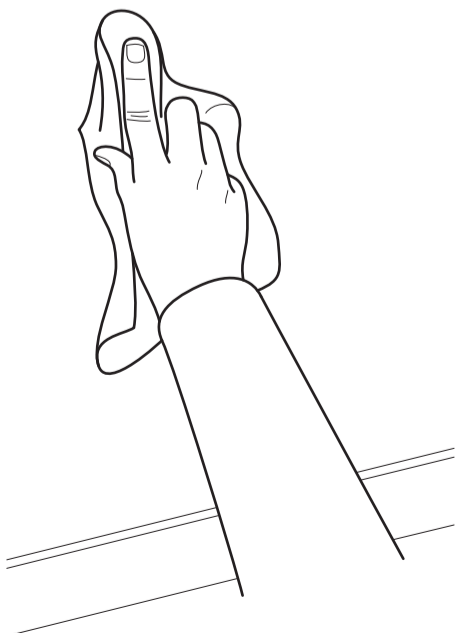

**ii**

Remove backing paper from the self adhesive strips on wall strip **A**.

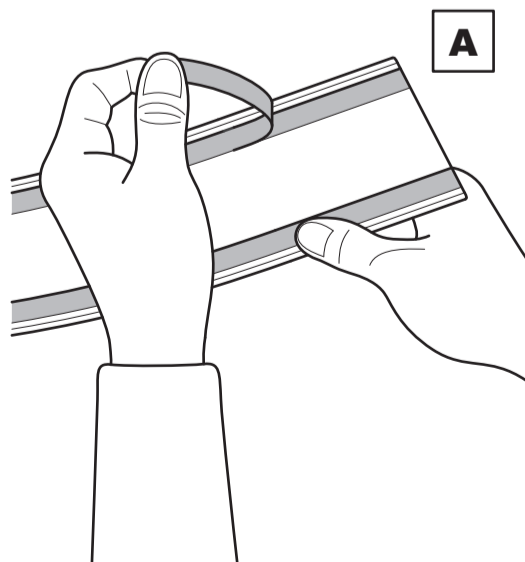

**iii**

Using a spirit level as a guide, carefully stick wall strip **A** to the wall.

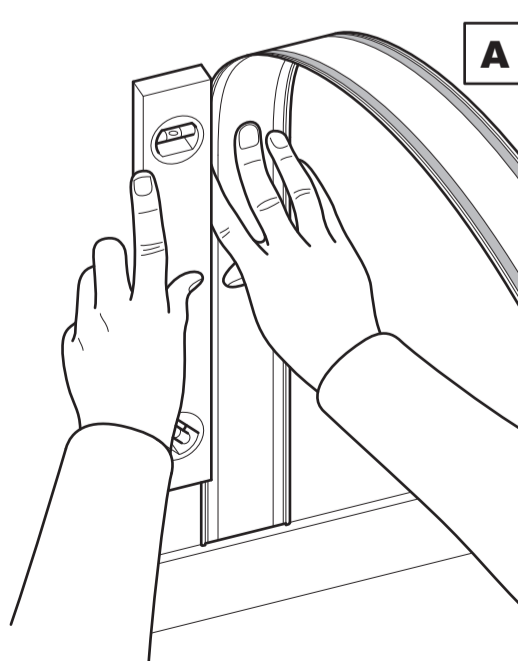

**iv**

Using a clean, dry cloth firmly press and rub up and down in the channels to ensure all air bubbles have been removed from wall strip **A**. Repeat after 5 minutes to ensure wall strip **A** is firmly attached to the wall.

